



MICHIGAN STATE
UNIVERSITY | Extension



• *BARRY COUNTY 4-H
HORSE PROGRAM*

revised 2025



THE 4-H PLEDGE

I pledge...



my **HEAD** to clearer thinking.



my **HEART** to greater loyalty.



my **HANDS** to larger service.



my **HEALTH** to better living.

For my **club**, my **community**,
my **country** and my **world**.

Table of contents

	Rules & Requirements	Patterns
Page #		Page #
	1. 4H Code Of Conduct	48. Draft Horse Driving Pattern Criteria
	2. List of Barry County 4H Council board members	49 - 53 Reining Criteria Explanation
	3. Date Requirements for Fair- Leaders	54. Reining Pattern 1
	4 Date Requirements for Fair- Parents and Members	55 Reining Pattern 2
	5 4H QR Codes	
	6-7 Rules for workouts at the fairground, Helmet Rules, & Lease/Borrow Rules	
	8 -9, High Point Selection (State Show)	56. Basic Riding Pattern 1 Basic
	10. Skills Demonstration Test Form	57. Riding Pattern 2
	Record / Project Books	58. Basic Riding Pattern 3
	11. Guidelines for Horse/Pony Record books	
	12. Score Sheet	
	13 -19. Horse and Pony Record Book	WalkTrot Pattern
	20-26. 4H Horse Science Project Workbooks (must select two)	59. Walk - Trot Pattern
	Show Bills / Instructions	60 8 year old Walk Trot Canter Pattern
	27. Point show sign-in instructions	61-65 English Western Riding Pattern and Criteria
	28 - 30. Point Show	66. Ranch Riding Pattern 3
	31 - 33. Barry County Fun Fuzzy 50 / 50 Show & Show series	67-68 Dressage Introductory level test A - Walk Trot
	34 - 38. Fair Schedule	69 - 70 Dressage Introductory level test B - Walk Trot
	Forms	71 - 72 Dressage Introductory level test C - Walk Trot Canter
	39. Community Service Form	73 - 74 Dressage Training Level Test 1 Dressage Training
	40. Shot Form	75-76 Level Test 2
	41-42. Sponsorship form and instructions	77 - 78 Dressage Training Level Test 3
	43. Team Competition Registration	79 - 80. Dressage USEF First Level Test 1
	44. Senior- fair class registration form	81 - 82. Dressage First Level Test 2
	45. Junior- fair class registration form	
	46. Novice- fair class registration form	
	47. Young Clover / Walk Trot- fair class registration form	



4-H Code of Conduct

Positive behavior is a key expectation for youth and adults participating in 4-H activities – behavior that reflects trustworthiness, respect, responsibility, fairness, caring and citizenship. Participants are expected to exhibit good sportsmanship and follow all event rules. Theft, vandalism, the use of illegal drugs, alcohol, tobacco or electronic cigarettes, inappropriate or threatening behavior that violates the rights of others, and other such offenses are strictly prohibited, and anyone involved with these offenses will immediately be sent home at his or her own expense. If it is determined by 4-H staff or persons in charge of the activity that the offense warrants it, the offender will be turned over to the proper authorities. Participants are expected to take responsibility for their own actions and encouraged to inform their 4-H leader or 4-H Staff if another person is mistreating them.



MICHIGAN STATE
UNIVERSITY

Extension

For questions not answered by this document or your leader contact one of the following Barry County 4H Horse Council board member:

President -Patty Snyder - 269-924-9886

Vice President- Mary Slocum - 269-948-2130

Secretary - Ashley Delany- 616-889-4998

Treasurer- Samantha Titlus - 269-830 - 9470

Show Committee Chair-Theresa Ferris-269•838-2308

Show Committee Series Chair - Melissa Hubert - 269 -206-9774

Barn Superintendent- Christina Miller - 269- 953-6718

Online Packet information:

www.canr.msu.edu/barry/barry_county_4_h/animal_science/horse_pony

Send any paperwork to barrycountyhorseleaders@gmail.com



Date Requirements for Fair

Leaders:

March 1: Turn in pre-registration "pink sheet" with members showing horses.

Note to Leaders: Coggins and Shots must be stapled to the Point show/Fair preregistration form. You may not turn in your club's forms until all of your 4-H's forms are present. Please have your forms STAPLED and turned in ON TIME...

April 30 or at Fun Show - Turn in ALL of your club's Horse Declaration Packets to one of the Board Members, this will include the following:

- Horse Blue Declaration form or Green for Young Clovers, include backup horses (if desired, but shot and coggins are not required until used) A horse must be on one of these forms to be used for 4H. Can be from another club's sheet.
- Coggins shot form and receipt for every declared horse with the *child's* name on each peice of paper.
- Pre-registration form for Point Show and Fair class selections
- Turn in Team comp forms and t-shirt payment

June Point Show

- Notebook Judging is done for EVERYONE except Young Clovers.
- Turn in Community Service Forms at announcer's booth (you may have leader collect and turn in as a club)
- State Delegate Forms (exact date to be announced)
- Community service forms (if you want them to count points towards state delegate and high point) must be turned in by this show

June Leaders Meeting-

- Give barn superintendent number of horses needing sawdust

July

- To attend fair with a horse, youth must complete either:
 - A. (record keeping plus 2 topics from appropriate age level old workbook and the 4H Horse/Pony and My 4H Story
 - B. A Poster/educational display plus Record Keeping with 4H Horse/Pony and My 4H Story
- Have it judged on non-livestock day .
- Get stall assignments



Date Requirements

4-H'ers / Parents:

NOTE TO PARENTS: *Coggins and Shots must be stapled to the Point show/Fair preregistration form by April 30th. Your club may not turn in any forms until all Club Members' forms are present. Please have your forms stapled and turned in on time.*

MARCH MANDATORY PARENT MEETING – ALL LEADERS AND PARENTS SHALL ATTEND

- Parents will receive a packet of materials and instructions to help our 4-Her's to have a successful year.

April Club Meeting

- Horses must be in members possession as of April 30th so that shots, Coggins, and pre-registration for classes can be turned in by the leader.
- Staple the following together and turn in for each declared horse. *Make sure your child's name is on the top of the Coggins and shot receipt as sometimes names on coggins or shot receipt do not match.*

These can also be turned in at the Fun and fuzzy 50/50 Show:

- Coggins
- Shot Form and Proof of shots (receipt)
 - *Eastern/Western sleeping sickness, Tetanus, Influenza, Rhino*
- Point Show / Fair Class Selection Form - Fully Completed – **Make sure to make a copy for yourself.**
- Community service forms - are to be turned in either with the above information or by the First Point Show. Box will be at the Fun and fuzzy Show, June Point Show.
- This gives you additional points towards state show.

Patterns for Reining, Basic Riding, Walk/Trot Pattern, English Western Riding, Dressage can be obtained on the website or from your leader. The website is:

**http://msue.anr.msu.edu/county/harry/harry_county_4_h/animal_science/horse_pony_or_google_BarryCounty_3-H- this also brings up the face book Club page*

JUNE MEETING

- Turn in Team competition form with signatures and money to your leaders. Or turn in by June point show at latest.

June Point Show

- State Show- Worker Signup (**NO WORKERS/NO DELEGATES!**)
- Community Service forms are due at the first show to earn points for state and high points.
- Turn in Team Comp registration and money to leader.

July To attend fair with a horse, youth must complete either:

- A. Record Book with My 4H Story and My 4H Horse/Pony and 2 topics from age appropriate workbook
- B. Record Book with My 4H Story and My 4h Horse/Pony and a Poster or educational display
- Must exhibit it on NON-Livestock Day at the Fair (Saturday before horses are brought in on Sunday).

4-H Shortcuts



Horse & Pony Page



Young clover work book



4-H Horse Program Packet



4-H Online



4-H Scholarships / Awards

4-H Horse Workouts, Helmets & Leased/Borrowed Horse Projects

4-H Horse Workouts -

The purpose of having workouts at the fairgrounds is;

- o For the 4-H leaders to provide 4-H members education in various riding disciplines and/or ground work.
 - o To assist 4-H members preparing their horses for shows and fair.
 - o For the 4-H member and their horse/pony to become familiar with the surroundings at the fairgrounds prior to the fair.
-
- If 4-H Leaders (defined as an adult volunteer who has completed the VSP process) who are experienced riders wish to bring in their horse and ride with their club members as a teaching aid they may do so.
 - The safety of our youth is of utmost importance. In the event there is a safety issue during a workout, a *4-H leader, who is an experienced rider*, may get on the member's horse to assist in working out the problem.
 - It is MSUE Barry County policy that workouts are not an open exercise time for anyone outside of 4-H members (currently enrolled in Barry County 4-H).
 - MSUE Liability Insurance covers volunteers serving in a 4-H volunteer capacity at a 4-H sanctioned event.
 - The Insurance purchased by the Horse Developmental is only in effect for the fun show, series, open shows and tack sale
 - Be sure to follow all laws/rules and safety precautions when transporting both youth and horses.
 - If a 4-H member leases or borrows a horse for 4-H, the 4-H member participate in the club they are a member of with the leased or borrowed horse.

Helmets -

Rule #1 in the fair book safety rules states "SEI safety helmets must be worn by 4-H members, parents, leaders and all youth exhibitors while mounted at any 4-H event. Young Clovers must wear helmets at all times when handling horse.

Barry County 4-H Leased/Borrowed Horses Projects

- Horses may be leased or borrowed for 4-H projects.
- Owner of the horse that is leased or borrowed may not stipulate the 4-H Club the member using the horse participates in. This choice is up to the family leasing or borrowing the horse.
- Parents & owners work out the agreement, 4-H is not involved.
 - o Things to think about include transportation, care, shows and practices.
 - o The leased or borrowed horses are expected to be at the club workouts/events. How they get there needs to be worked out as part of the agreement.
 - o 4-H members are expected to follow the rules of the 4-H Club they belong to.
- The expectation is that 4-H members participate in the club they are a member of with the leased or borrowed horse.

Revised 2025

HIGH POINT SELECTION SYSTEM

POINTS; 1ST – 6, 2ND – 5, 3RD – 4, 4TH – 3, 5TH – 2, 6TH – 1

Points are based on the judge's discretion which means they are allowed to give however many points they feel a member deserves based on how well they performed in a class. Just because you receive first place does not always mean you will get six points and as well for the rest of the placings. Also, points may be divided by as much as a ½ point (example 5.5) if a judge feels it was a close decision in placing the class.

These are just **EXTRA** points at “**FAIR ONLY**” if you receive one of the medals and/or a ribbon award.

Gold Medal – 3 points

A ribbon award – 3 points

Silver Medal – 2 points

B ribbon award – 2 points

Bronze Medal – 1 point

C ribbon award – 1 point

****Each member that does Showmanship at the Point Show and Fair receives 2 extra points.**

Community Service: each member receives 10 points.

Questions: members are asked 3 questions and for each correct answer they receive 2 points each and if close they may get 1 point. Questions are given Thursday morning of Fair week. Questions come from the Horse Science Book and Horse and Horsemanship Book.

High Point

Seniors 1st – 6th placings

Juniors 1st – 6th placings

Novice 1st & 2nd placings

Walk/Trot 1st & 2nd placings

Total points are accumulated from last year's fair and questions. This year's Point Show and Community Service. Trophies and ribbons are awarded for these placings.

STATE SHOW

The State Show is based on the total points each member has accumulated from last year's fair and questions, this year's point show, and community service. Whoever receives the highest total scores is eligible to attend the State Show. We will send 14 Delegates and 4 Alternates.

Ages for State Show (determined as of January 1st) 12 – 19 years.

(Juniors 12 – 15 years, Seniors 16 – 19 years)

****NOVICE AND WALK/TROT ARE NOT ELIGIBLE FOR STATE SHOW.**

SHOW OF CHAMPIONS

The Grand Champion Senior and Junior Showmanship winners are eligible for the Show of Champions which is held last Saturday of Fair. If you are unable to compete or will compete with a different species, please contact one of the board members or the Reserve Champion as soon as possible, in order to give them time to work with the other species as well. Once you have won the Show of Champions as Grand Champion, you are no longer able to compete in this event.

Barry County 4H Skills Demonstration					
Name:		Club:		Leader:	
Year:		Age:		Back Number:	

Dismounted Abilities				Sufficient	Needs Work
Tie a proper safety knot					
Lead your horse safely at a walk and trot					
Halt and back your horse safely					
Bridle your horse and adjust chin strap and throat latch accordingly					
Saddle your horse and adjust girth and Stirrups appropriately					

Mounted Abilities				Sufficient	Needs Work
Mount Properly					
Place feet in stirrups and pick up reins properly					
Walk your horse					
Trot you horse					
(If wtc) Canter your horse					
Reverse directions					
Repeat					
Halt and back					
Demonstrate safe following distance and passing etiquette					

Jumping				Sufficient	Needs Work
Ride into the stirrup and keep eyes up					
Show adjustability at the canter					
Correctly perform a half seat					
Know and understand basic jumping terminology					

		Class level	w/t	novice	novice int	Age group
Leader reccomendation:						





Barry County

GUIDELINES FOR HORSE/PONY RECORD BOOK AND WORKBOOK

1. To attend fair with a horse, youth must complete either a workbook or a Poster/educational display and with Record Keeping Section

2. The workbook includes

A. Two topics from the age appropriate prior versions of the workbook as determined by the leader or

B. An educational poster/project

And a record keeping section with and My Horse/Pony Story and My 4H Story

3. Judge will judge only current year record book. Previous workbooks will be included in the binder, but will not reflect on year being judged. Include a divider between each record book.

4. It will be the leader's discretion as to what workbook youth need to complete for the current year.

5. A table of contents will be required for all workbook and record books (except Young Clovers).

6. All record books must include a score sheet in the front of the record book.

7. Score sheets need to be kept in the record book until fair.

8. Record books and workbook educational project must be judged on Non-Livestock Day of Fair.

4-H HORSE WORKBOOK SCORE SHEET (Ages 9 – 19)

Not intended for Young Clovers

NAME _____

AGE: _____ Years in Project _____ Work Book # _____

❖ * **Special Needs:** If your child has a disability you would like the judge to take into consideration when judging the notebook, please place a ** in front of your child's name.

	Possible	Received
General Elements:		
1. General Appearance	10	
2. Table of Contents	10	
3. Neatness and orderliness	10	
Contents: CURRENT YEAR ONLY		
1. Required Materials	30	
2. Accuracy	30	
Presentation;		
1. verbal knowledge of material covered in book	10	
Subtotal		
Bonus Points (apply to best of show and outstanding only)		
Extra personal effort		
Photo Records (training, injuries, illness, etc.)		
Extra eye appeal, extensive reporting, etc.		

Total

- 100 + Exceptional workbook (eligible for Best of Show)
- 95+ Eligible for Outstanding Exhibit
- 80-100 A Ribbon
- 60-79 B Ribbon
- Below 59 C Ribbon

Notes: _____



EXHIBITOR# -----

DATE-----

THE RIDER

HORSE AND PONY RECORD BOOK

(Age as of January 1, of the current year.)

REVISED 2025

NAME-----

AGE-----

ADDRESS-----

CITY/COUNTY-----

ZIP CODE-----

DATE OF BIRTH-----

YEARS IN HORSE PROJECT-----

4H CLUB NAME-----

4H CLUB LEADER-----

LEADER'S PHONE#-----

HORSE'S/PONY'S HEALTH

VETERINARIAN'S NAME-----

PHONE-----

VITAL SIGNS (have someone help you take your horse's vital signs.)

HORSE'S TEMPERATURE IS:---

RESPIRATION IS:--

PULSE IS:---

IMMUNIZATIONS ARE REQUIRED TO PARTICIPATE IN THE BARRY COUNTY FAIR (ask your leader for required shots). YOU MAY CONSULT YOUR VETERINARIAN FOR SHOTS HE/SHE RECOMMENDS FOR YOUR HORSE. PLEASE INCLUDE A COPY OF SHOT DOCUMENTATION AT THE END OF YOUR BOOK.

IMMUNIZATIONS

WHAT DOES "IMMUNIZATION" MEAN? -----

WHY DO YOU IMMUNIZE YOUR HORSE/PONY AND ON WHAT DATES? WHAT DOES EACH VACCINATION DO FOR YOUR HORSE? WHAT IS THE COST?

DEWORMING

WHY DO YOU DEWORM YOUR HORSE/PONY?

HOW OFTEN DO YOU GIVE YOUR HORSE/PONY WORMING MEDICATION?

WHAT IS THE NAME OF THE DEWORMER YOU HAVE USED AND WHAT WAS THE COST?

EXAMS, ILLNESSES AND INJURIES

DID YOUR HORSE/PONY GET HURT OR SICK THIS YEAR? IF SO, TELL US ABOUT IT. IF NOT, HOW DID YOU KEEP YOUR HORSE/PONY HEALTHY?

FEEDING AND BEDDING

TELL US ABOUT WHERE YOUR HORSE/PONY LIVES

DOES YOUR HORSE/PONY HAVE A BARN OR SHELTER TO STAY IN? CAN YOU DESCRIBE IT? WHAT KIND OF BEDDING DO YOU USE?

DO YOU FEED YOUR HORSE/PONY HAY OR GRAIN? WHAT KIND OF HAY AND GRAIN, HOW OFTEN DO YOU FEED, AND WHAT IS THE COST?-----

HOW OFTEN DOES A FERRIER SEE YOUR HORSE? WHAT IS THE COST? WHAT DOES YOUR FERRIER DO FOR YOUR HORSE?-----

DOES YOUR HORSE/PONY NEED MEDICINE OR SPECIAL SUPPLEMENTS? IF SO, WHAT ARE THEY?

DOES YOUR HORSE/PONY GET TREATS OR A SALT BLOCK? IF SO, TELL US ABOUT THEM

LIST 2 SAFETY RULES:

MY 4H STORY: (TELL US ABOUT YOUR 4H EXPERIENCE)

MY HORSE:

4-H HORSE SCIENCE PROJECT WORKBOOKS
[MUST SELECT TWO (AGE APPROPRIATE) TO ADD TO YOUR RECORD BOOK]

WORKBOOK A (Young Clover Age 5)

WORKBOOK B (Young Clover Age 6)

WORKBOOK C (Young Clover Age 7)

WORKBOOK D (Young Clover Age 8)

Obtain a workbook from your leader or the MSU Extension office. Follow the instructions. Complete the pages, make your own cover and put in booklet form. Add pictures of you and your horse/pony. Write about your 4-H horse/pony.

WORKBOOK 1

Thirty parts of the horse: Draw or trace a picture of a horse and label the parts.

NECK	SHOULDER	BARRELL	BACK	HEAD
FLANK	HIP	BUTTOCKS	TAIL	CANNON
FORELOCK	FETLOCK	POLL	PASTERN	GROUP
HEART GIRTH	MANE	STIFLE	GASKIN	CORONET
KNEE	HOOF	POINT OF HIP	LOIN	HOCK
ARM	FOREARM	WITHERS	CHEST	CREST

Feeding: What do you feed and how many times a day? Why water is important and how much does a horse need every day?

Three Breeds of Horse: Draft, Pony, Light Breed - Choose one breed in each category and discuss size, conformation and uses.

Colors of Horses: Describe these five colors - black, bay, white, chestnut and brown.

Horse Markings: Draw a picture showing the different face and leg markings.

Horse Talk: Discuss how horses talk, sounds they make and body language.

Western Saddle: Show a picture and label the parts.

Western Bridle and Bits: Show a picture and label the parts of the bridle. Show a picture of a curb bit and a snaffle bit. Explain the differences between the bits.

Unsoundness: Thrush and founder, what are they and how are they treated?

Five Safety Rules

WORKBOOK 2

Forty-five parts of the horse: Draw or trace a picture of a horse and label the parts.

MUZZLE	HOCK	CANNON	NECK	TAIL
FOREHEAD	HOFF	CREST	ERGOT	ANKLE
BARREL	JAW	BACK	FACE	GASKIN
BUTTOCKS	CHEEK	DOCK	SHOULDER	POINT OF HOCK
KNEE	UNDERLINE	HEART GIRTH	FOREARM	POLL
NOSTRILS	STIFLE	TH ROATLATCH	HIP	BARS OF MOUTH
WITHERS	FORELOCK	CORONET	FETLOCK	POINT OF HIP
GROUP	ELBOW	WINDPIPE	MANE	COUPLING
PASTERN	FLANK	ARM	LOIN	CHEST

Horse Health: Tell what a healthy horse looks like and how he acts. What can you do to keep your horse healthy?

Colors of Horses: Describe these six colors - gray, palomino, roan, dun Appaloosa, paint/pinto.

Hoof Care: Describe daily care and routine farrier care, trimming/shoeing.

English Bridle and Bits and Saddle: Saddle, bridle, kimberwick and pelham, show a picture of each and label the parts.

Basic Tack Care: Describe how to clean tack and what products to use.

Ten Safety Rules

Vices: Shying and biting, why do they happen and how do you stop the vices?

The Aides: Hands, voice and legs, tell how each is used.

WORKBOOK 3

Basic Feeds: Two grains - corn and oats, two hay types - alfalfa and grass, describe each and how the horse benefits from eating each.

Show Grooming: Rub rag, scissors/clippers, sponge, sweat scraper, mane and tail comb. Write a paragraph describing how to groom a horse for a show using each of these items.

Unsoundness: Splints and shoe boil, what are they and how are they treated?

Three Gaits: Walk, trot and canter - describe the different beat and footfalls of each gait.

The Aids: Heels, weight and seat - tell how each is used.

Vices: Kicking and halter pulling - why do they happen and how do you stop these vices?

Breeds: Three light horse breeds - discuss how they are different in conformation and use. Show a picture of each.

Cooling Out: Write a paragraph discussing what cooling out is and why it is done.

The Horses Vision: Describe basically how a horse sees.

WORKBOOK 4

Breed Report: Choose one breed, show a picture, tell its history and discuss its different uses.

Waste Management: Write a paragraph explaining two methods of disposing of your horse waste.

Conditioning the Horse for Showing: Discuss how to condition the horse and why it's important to do so.

Sportsmanship/Ring Etiquette: Explain what they are and discuss how they are the same and how they are different.

Leads: Write a paragraph discussing what a lead is and how to cue the horse to take a lead.

Unsoundness: Ringbone, bog spavin and capped hock - what are they and how is each treated?

Vaccinations: Write a paragraph discussing when and why a horse needs annual vaccinations. List the most common injection sites and areas to avoid.

First Aid: List common items you should always have on hand in your barn and what each is used for.

WORKBOOK 5

Unsoundness: Fistula of the withers and heaves - what are they and how is each treated?

Vices: Barn sour and cribbing - why do they happen and how do you stop these vices?

The Age of a Horse: Discuss how a horse ages and how his teeth change with age.

External Parasites: Name the common external parasites and discuss how to prevent them and the treatment for them.

Internal Parasites: Name the common internal parasites and discuss how to prevent them and the treatment for them.

Worming Program: Discuss why it's important to worm your horse. Name the different types of worming medications on the market. Discuss the three methods of worming (paste, granular and tubing) and explain how they are different and the same. List the advantages and disadvantages of each medication used including costs. Outline a worming program.

Diseases: Pick a disease not on workbook 8 and discuss in detail including cause, treatment and expected outcome.

Shipping Fever: What is it? How is it treated and can it be prevented?

WORKBOOK 6

Bone Structure: Show a picture of a horse skeleton. Label the bones and discuss the ideal angles of the shoulder, hip, stifle, hock and pastern. Why are the ideal angles important to conformation and function?

Breed Report: Discuss one breed of draft horse. Show a picture. Discuss the history of the breed, its conformation, color and markings. Discuss the most common use of this breed and any other work/sport man may use it for.

Unsoundness: Quarter crack and sidebone - what are they and how is each treated?

Vices: Rearing and pawing-why do they happen and how do you stop these vices?

Digestive System: Show a picture and label parts. Discuss how a horse digests his food. Tell how the different feeds/hay are digested and used by the horse's body. Discuss how a feeding program may change depending on how the horse is used and what his physical needs are.

Colic: What is it and what potential risk does it pose to the horse? What causes it and how is it treated? How can it be prevented?

The Horse's Teeth: Discuss how the teeth grow and wear. How does environment and food sources affect horse's teeth? What can the horse owner do to care for his horse's teeth?

Workbook 7

Muscles of the Horse: Show a picture of the horse's muscles. Label the muscles. Pick a major muscle group to describe and explain how it works.

Founder: Discuss the clinical signs and causes, treatment and prevention.

Equine Careers: Report in depth on two equine careers including preparation and schooling.

WORKBOOK 8

Equine Diseases: Discuss the clinical signs and symptoms, mode of transmission, treatment and prevention for each of the following diseases.

Equine Influenza

Equine Rhinophneumonitis

Eastern, Western and Venezuelan Encephalomyelitis

Equine Viral Arteritis (EVA)

Equine Infectious Anemia

Potomac Horse Fever

Strangles

Tetanus

West Nile

(Please note: for this report you may find it helpful to talk to your veterinarian).

WORKBOOK 9

Parasites: External Parasites

Flies: list the different species of flies common to horses and discuss control and insecticides.

Discuss the clinical signs, treatment and prevention of the following external parasites - cattle grubs, lice, ticks, mites and blister beetles.

Parasites: Internal Parasites

Discuss prevention and control of each of the internal parasites listed below. Make a life cycle diagram and give a brief explanation of how each parasite migrates through the horse.

Ascarids (roundworms)

Stonglyles (bloodworms)

Pinworms

Stomach bots

Strongloides (threadworms)

Tapeworms

(Please note: for this report you may want to contact your veterinarian for additional information, or you may choose to contact a few manufactures of the common products you use for your horse and ask them for information).

WORKBOOK 10

The Broodmare

Include a picture and label the reproductive organs of the mare. Discuss the following topics related to the cure of the broodmare.

Heat cycle length and the influence of the time of year on the heat cycle.

Manipulation of the heat cycle.

How many times to breed during the heat cycle and the best time to achieve conception.

How to tell when a mare is receptive to a stallion.

Care of the pregnant mare:

Vaccinations

Worming - when and how often

Hoof care

Feeding - supplements, hay and grain.

Foaling - progression of labor and birth

After foaling - mare care

Care of the mare during weaning.

(Please note: for this report it may be helpful to contact a breeding facility and ask if you could observe their operation. Explain to them you are doing a report for 4-H).

WORKBOOK 11

The Breeding Stallion

Include a picture and label the reproductive organs of the stallion. Discuss the following topics related to the care of the stallion.

What to look for in a breeding stallion.

Different methods of breeding (minimum of three). Explain each method and the pros and cons.

Breeding hygiene.

Breeding program.

Genetics.

WORKBOOK 12

Traveling - National and International

Discuss the following in detail.

Requirements - vaccinations, health certificates, etc.

Travel safety.

Trailer safety.

Plan a road trip from Michigan to California with a travel itinerary.

Equine liability

POINT SHOW/FAIR SIGN-IN INSTRUCTIONS

POINT SHOW START AT 8:30 A.M.

FAIR CLASSES BEGIN ON MONDAY WITH SHOWMANSHIP AT 9:00 A.M. (SEE Fair SCHEDULE IN PACKET FOR MORE DETAILS OF FAIR WEEK.) TUESDAY AND WEDNESDAY CLASSES BEGIN AT 9:00 A.M. YOUNG CLOVER CLASSES BEGIN AT 10:00 ON THURSDAY.

ONLY POINT SHOWS HAVE FEES- FAIR CLASSES ARE FREE EXCEPT FOR TEAM COMPETITION

CLASS FEE: \$5.00 PER CLASS

OFFICE FEE: \$PER 4.00 Per RIDER

SIGNING IN FOR THE DAY: (POINT SHOW) SIGN-IN BEGINS AT APPROXIMATELY 7:15 A.M. OFFICE WILL CLOSE 15 MINUTES BEFORE THE FIRST CLASS BEGINS TO ALLOW TIME TO MAKE SURE ALL ENTRIES ARE IN THE COMPUTER AND CLASS SHEETS ARE PRINTED. WILL RE-OPEN AFTER SHOW IS STARTED.

1. Stop at the tables outside the office and obtain a printout which shows the classes that have been signed up for by the pre-registration deadline.
2. Pick up your back number and pins if needed at the table outside. This will be your number for the current year at Point Shows and Fair.
3. Verify by comparing the printout received and your copy of your sign-up sheet (some of us have fat fingers when typing in the computer) that we have the correct classes. If you need to change anything please do so on the print-out and date and initial. You may need to note that you may not be showing a particular class at this show but intend to do so at a later date or have already shown the class at a prior show but are not showing this day for one reason or another (forgot tack, can't stay, etc.)
4. Go in to the registration desk and pay your fees and bring any changes to the attention of the person collecting your fees.

All corrections prior to Fair need to be done by June Point Show.

Fair Sign-in will be Sunday 5-7:00. Team Comp meeting at 7:00. Must sign in during announced times to be eligible to show.

Report to the gate person at the ring in which you are to be showing. This the riders responsibility to check in to the gate person with their number and to be ready. If tack changes are required please inform the office **and** the gate person a couple of classes ahead. Many times the next class will enter the ring before the class in the ring is announced. Be sure to listen carefully as order or location of classes are sometimes changed, especially Showmanship and Halter.

Speed: competitors are expected to enter the ring within one minute of their being called. The next 5 riders will be required to be in a holding area setup near the in gate. If there is a conflict with another class they may be run out of order. Be sure to inform both the gate and the office. **You may enter the arena when the previous rider has dismounted if they will not interfere with your pattern.**

Be sure you slow down, break gait, or turn away from the gate within the Control Box to avoid a 5 second penalty.



RING 1

SENIORS AND SPEED 8:30 A.M.

SHOWMANSHIP-WATCH FOR RING ASSIGNMENT

- 1 SHOWMANSHIP 17 AND OVER
- 2 SHOWMANSHIP 15 AND 16
- 3 SHOWMANSHIP 13 AND 14 (RING 1B)
- 9 SHOWMANSHIP YOUNG CLOVER 5-6 YEAR OLDS
- 10 SHOWMANSHIP YOUNG CLOVERS 7-8 YEAR OLDS
- 144 SHOWMANSHIP 8 YEAR OLDS WTC

DON'T START HALTER UNTIL SHOWMANSHIP IS COMPLETE

HALTER- WATCH FOR RING ASSIGNMENT

- 11 HALTER FINE HORSE (ARAB,MORGAN, TB, GAIED, ETC.
- 12 HALTER COLOR (50% COLOR, 50% CONFORMATION)
- 13 HALTER REGISTERED STOCK TYPE

YOUNG CLOVERS

- 140 HORSEMANSHIP LEADLINE 5-8 YEAR OLDS
- 141 HORSEMANSHIP 7 & 8 YEAR OLDS
- 142 PLEASURE LEADLINE 5-8 YEAR OLDS
- 143 PLEASURE 7 & 8 YEAR OLDS

JUMPING AND DRESSAGE WILL RUN AT THE SAME TIME AS YOUNG CLOVERS DON'T START UNTIL DRESSAGE IS OVER

WARM-UP

ENGLISH

- 101 SUITABILITY FOR DRESSAGE 13 AND OVER
- 21 DRESSAGE EQUITATION 13 AND OVER
- 23 HUNT SEAT EQUITATION 16 AND OVER
- 24 HUNT SEAT EQUITATION 13 TO 15
- 32 HUNT SEAT EQUITATION 2,3,4,5 YEAR OLD HORSE, ALL AGES
- 26 HUNT SEAT EQUITATION PONY 13 AND OVER
- 28 HUNT SEAT PLEASURE 16 AND OVER
- 29 HUNT SEAT PLEASURE 13 TO 15
- 33 HUNT SEAT PLEASURE, 2,3,4,5 YEAR OLD HORSE, ALL AGES
- 31 HUNT SEAT PLEASURE PONY 13 AND OVER
- 36 EQUITATION SADDLE SEAT ALL AGES
- 37 PLEASURE SADDLESEAT ALL AGES

WARM-UP BEFORE WESTERN BEGINS

WESTERN

- 42 HORSEMANSHIP 17 AND OVER
- 43 HORSEMANSHIP 15 AND 16
- 44 HORSEMANSHIP 13 AND 14
- 48 HORSEMANSHIP, PONY, 13 AND OVER
- 56 HORSEMANSHIP SPEED 13 TO 15
- 57 HORSEMANSHIP SPEED 16 AND OVER
- 34 HORSEMANSHIP 2,3,4,5 YEAR OLD HORSE, ALL AGES
- 50 PLEASURE STOCK TYPE 13 AND OVER
- 52 PLEASURE FINE TYPE 13 AND OVER

35 PLEASURE 2,3,4,5, YEAR OLD HORSE

54 PLEASURE PONY 13 & OVER

104 BAREBACK EQUITATION 13 & OVER

POINT SHOW BILL

WARM-UP AND SET-UP

SPEED

- 70 POLE BENDING, NOVICE, ALL AGES
- 71 POLE BENDING, INTERMEDIATE NOVICE, ALL AGES

- 80 POLE BENDING 9 TO 12
- 81 POLE BENDING 13 TO 15
- 82 POLE BENDING 16 AND OVER

- 72 KEYHOLE, NOVICE, ALL AGES
- 73 KEYHOLE, INTERMEDIATE NOVICE, ALL AGES
- 83 KEYHOLE 9 TO 12
- 84 KEYHOLE 13 TO 15
- 85 KEYHOLE 16 AND OVER

- 74 SPEED AND ACTION, NOVICE, ALL AGES
- 75 SPEED AND ACTION, INTERMEDIATE NOVICE, ALL AGES

- 86 SPEED AND ACTION 9 TO 12
- 87 SPEED AND ACTION 13 TO 15
- 88 SREED AND ACTION 16 AND OVER
- 136 SPEED AND ACTION, DRIVING, ALL AGES

- 149 CLOVERLEAF 8 years wrc
- 76 CLOVERLEAF, Novice, ALL AGES
- 77 GLOVERLEAF, INTERMEOIATE NOVICE, ALL AGES
- 89 CLOVERLEAF 9 TO 12
- 90 CLOVERLEAF 13 TO 15
- 91 CLOVERLEAF 16 AND OVER
- 137 CLOVERLEAF DRIVING ALL AGES

- 78 INDIANA FLAG RACE, NOVICE, ALL AGES
- 79 INDIANA FLAG RACE, INTERMEDIATE NOVICE, A.LL AGES

- 92 INDIANA FLAG RACE 9 TO 12
- 93 INOIANA FLAG RACE 13 TO 15
- 94 INOIANA FLAG RACE 16 AND OVER

REVISED 2025



POINT SHOW BILL

RING 2

JUNIORS- WALK/TROT, NOVICE, PERFORMANCE

8:30 A.M. SHOWMANSHIP-- WATCH FOR RING

ASSIGNMENTS

- 4 SHOWMANSHIP 11 TO 12
- 5 SHOWMANSHIP 9 TO 10
- 6 SHOWMANSHIP NOVICE
- 7 SHOWMANSHIP INTERMEDIATE NOVICE
- 8 SHOWMANSHIP WALK/TROT ALL AGES

DO NOT START HALTER UNTIL SHOWMANSHIP IS COMPLETE

HALTER RING ASSIGNMENTS MAY CHANGE

- 14 HALTER GRADE
- 15 HALTER PONY
- 145 HALTER ALL BREEDS 8 YEAR OLDS

DRESSAGE RING AND JUMPING WILL BE RUN DURING YOUNG CLOVERS

JUMPING

- 130 HUNTER HACK, CROSS POLES(MAY NOT SHOW ANY OTHER JUMPING CLASS)
- 131 HUNTER HACK. 18 INCHES
- 132 HUNTER HACK. 2 FOOT
- 133 HUNTER HACK, 2 FOOT SIX INCHES

ENGLISH (ENGLISH & WESTERN 2, 3,4,5 YEAR OLD CLASSES ARE IN RING 1

SADDLE SEAT WILL RUN IN RING 1

DONT START UNTIL DRESSAGE IS DONE

WARM-UP-start after both rings are done

100 SUITABILITY FOR DRESSAGE 12 AND UNDER

20 DRESSAGEEQUITATION 12 & UNDER

151 ENGLISH EQUITATION W/T

60 ENGLISH EQUITATION NOVICE ALL AGES

- 61 ENGLISH EQUITATION, INTERMEDIATE NOVICE,
- 22 HUNT SEATEQUITATION 12 & UNDER
- 50 ENGLISH PLEASURE W/T
- 25 HUNT SEAT EQUITATION PONY 12 AND UNDER
- 62 ENGLISH PLEASURE, NOVICE, ALL AGES
- 63 ENGLISH PLEASURE, INTERMEDIATE NOVICE, ALL AGES
- 27 HUNT SEAT PLEASURE 12 AND UNDER
- 30 HUNT SEAT PLEASURE PONY 12 AND UNDER

WARM-UP BEFORE WESTERN BEGINS

WESTERN

- 146 HORSEMANSHIP ALL SEATS 8 YEAR OLDS
- 58 HORSEMANSHIP WALK/TROT, ALL AGES (MAY NOT SHOW CANTER CLASSES)
- 45 HORSEMANSHIP 11 TO 12
- 46 HORSEMANSHIP 9 TO 10
- 47 HORSEMANSHIP PONY 12 AND UNDER
- 64 HORSEMANSHIP, NOVICE. ALL AGES
- 65 HORSEMANSHIP, INTERMEDIATE NOVICE, ALL GES
- 55 HORSEMANSHIP SPEED 9 TO 12
- 68 HORSEMANSHIP, SPEED. NOVICE. ALL AGES
- 69 HORSEMANSHIP, SPEED, INTERMEDIATE NOVICE, ALL AGES
- 147 PLEASURE ALL BREEDS 8 YEAR OLDS
- 59 PLEASURE WALK/TROT ALL AGES
- 49 PLEASURE STOCK TYPE 12 AND UNDER
- 51 PLEASURE FINE TYPE (ARAB, MORGAN, TB ETC) 12 AND UNDER
- 53 PLEASURE PONY 12 AND UNDER
- 66 PLEASURE NOVICE, ALL AGES
- 67 PLEASURE, INTERMEDIATE NOVICE, ALL AGES

PERFORMANCE

- 102 VERSATILITY ALL AGES
- 103 BAREBACK EQUITATION 12 AND UNDER
- 96 REINING 12 AND UNDER
- 97 REINING 13 AND OVER
- 98 RANCH HORSE RIDING 12 AND UNDER
- 99 RANCH HORSE RIDING 13 AND OVER

DRIVING

- 138 DRIVING REINSMANSHIP
- 139 DRIVING PLEASURE, ALL AGES

PATTERN CLASSES

- 135 DRIVING PATTERN
- 105 ENGLISH/WESTERN RIDING
- 115 GREEN ENGLISH/WESTERN
- 106 BASIC RIDING 1 13 AND OVER
- 107 BASIC RIDING 1 12 AND UNDER
- 108 BASIC RIDING 2 ALL AGES
- 109 BASIC RIDING 3 ALL AGES

4-H POINT SHOW BILL BARRY COUNTY

Dressage testing starts after halter classes.

Dressage tests MUST be FINISHED before English classes can begin.
Young Clovers will be in Ring 1
Jumping will be in Ring 2

Ring 3

New Tests in 2019 thru 2023

Dressage contestants may only show in 3 tests at the Point Shows and Barry County Fair.

- 120 Introductory Level, Test A - **First year Dressage exhibitor or horse**
- 121 Introductory Level, Test B - **First year Dressage exhibitor or horse**
- 122 Introductory Level, Test C - **First year Dressage exhibitor or horse**
- 123 Training Level . Test 1
- 124 Training Level . Test 2
- 125 Training Level . Test 3
- 126 Level 1, Test 1 - Once successfully completed may not go back into training levels.
- 127 Level 1, Test 2

Volunteers needed for Patterns and Trail set-up.

8 YEAR OLDS

- 148 8 YEAR OLD PATTERN

WALK/TROT

- 111 Walk/Trot Pattern

TRAIL

- 112 TRAIL. NOVICE-NOVICE INTERMEDIATE
- 113 TRAIL. 12 AND UNDER
- 114 TRAIL. 13 AND OVER
- 134 TRAIL. DRIVING

Volunteers needed for Trail set-up and take-down.



Barry County Fuzzy show

(1/2 pleasure/1/2 speed....twice the fun!)

Showmanship

***Leadline showmanship

1. 12 and under W/T
2. 13 and over W/T
3. 12 and under
4. 13-15
5. 16-19
6. 20 and over

English Pleasure

****Lead line (any seat)****

7. 12 and under W/T
8. 13 and over W/T
9. 12 and under
10. 13-15
11. 16-19
12. 20 and over

English Equitation

13. 12 and under W/T
14. 13 and over W/T
15. 12 and under
16. 13-15
17. 16-19
18. 20 and over

Western Pleasure

19. 12 and under W/T
20. 13 and over W/T
21. 12 and under
22. 13-15
23. 16-19
24. 20 and over

Western Horsemanship

25. 12 and under W/T
26. 13 and over W/T
27. 12 and under
28. 13-15
29. 16-19
30. 20 and over

Trail and Ranch will run during pleasure

Trail

31. W/T all ages
32. 12 and under
33. 13 and over

Ranch Horse Pattern

34. W/T all ages
35. 12 and under
36. 13 and over

Barry County Fairgrounds

1350 M-37 Hastings, Mi

9:00 am Rain or Shine!

April 27, 2025

SPEED EVENTS (Approx. 2pm)

Poles

37. 12 and under
38. 13-15
39. 16-19
40. 20 and over

Stake Race

41. 12 and under
42. 13-15
43. 16-19
44. 20 and over

Flag

45. 12 and under
46. 13-15
47. 16-19
48. 20 and over

Barrels

49. 12 and under
50. 13-15
51. 16-19
52. 20 and over

- ❖ \$5/ class * \$5 office fee *(1 horse/rider combo)
- ❖ Judges decision is final
- ❖ Casual dress, long pants and boots required-Helmets required for 19 and under in speed classes
- ❖ W/T and leadline riders may compete in their age group in speed events.
*Leadline will not place above non assisted
- ❖ Negative coggins required
- ❖ Daily highpoint and reserve awarded for Pleasure and Speed
- ❖ **No refunds**
- ❖ Contact Show committee (Theresa Ferris- 269-838-2308)
- ❖ Barry County Fairgrounds and persons connected to this show are not liable for injury, damage or loss.
- ❖ **Absolutely NO alcohol, improper language, or altering substance use by anyone in attendance! Legal action will be taken and you will be asked to leave.**
- ❖ Please join us for our under the lights speed and pleasure series!
June 27/28, July 25/26, Sept 26/27





2025 BARRY COUNTY OPEN PLEASURE SERIES



Start Time

10am

**RAIN OR
SHINE!**

Barry County Fairgrounds 1350 M-37 Hastings, Michigan

Contact : Melissa Hubert (616) 206-9774

DATES

JUNE 28

JULY 26

SEPTEMBER 20

- **1. Halter Stakes
- *2. Halter Horses Ages 5 & Under
- *3. Stock Horse Halter
- *4. Fine Breed Halter
- *5. Color Breed Halter 50/50
- *6. Pony/ Mini Halter
- *7. Showmanship Stakes
- 8. Showmanship 20 & Over
- 9. Showmanship 16 - 19
- 10. Showmanship 13 - 15
- 11. Showmanship 12 & Under
- 12. Showmanship Walk/Trot 20 & Over
- 13. Showmanship Walk/Trot 13 - 19
- 14. Showmanship Walk/Trot 12 & Under
- 15. Leadline /Pee Wee Showmanship 8 & Under

20 MINUTE BREAK

- 16. Leadline any seat
- *17. English Pleasure Stakes
- 18. English Pleasure Ages 20 & Over
- 19. English Pleasure Ages 16 -19
- 20. English Pleasure Ages 13-15
- 21. English Pleasure 12 & Under
- 22. W/T English Pleasure 20 & Over
- 23. W/T English Pleasure 13 - 19
- 24. W/T English Pleasure 12 & Under
- 25. English Equitation 20 & Over
- 26. English Equitation 16 - 19
- 27. English Equitation 13 - 15
- 28. English Equitation 12 & Under
- 29. W/T English Equitation 20 & Over
- 30. W/T English Equitation 13 & 19
- 31. W/T English Equitation 12 & Under

30 MINUTE BREAK

Office Fee: \$5
Regular Classes: \$5
Stakes Classes: \$10
Daily High Point: \$6
Series High Point: \$25
Stalls \$30 Day or \$50
for the weekend.
Camping available
\$35/night.

- *32. Western Pleasure Stakes
- 33. Western Pleasure 20 & Over
- 34. Western Pleasure 16 - 19
- 35. Western Pleasure 13 - 15
- 36. Western Pleasure 12 & Under
- 37. W/T Western Pleasure 20 & Over
- 38. W/T Western Pleasure 13-19
- 39. W/T Western Pleasure 12 & Under
- 40. Western Horsemanship 20 & Over
- 41. Western Horsemanship 16-19
- 42. Western Horsemanship 13-15
- 43. Western Horsemanship 12 & Under
- 44. W/T Western Horsemanship 20 & Over
- 45. W/T Western Horsemanship 13-19
- 46. W/T Western Horsemanship 12 & Under
- 47. Bareback Equitation 20 & Over
- 48. Bareback Equitation 16-19
- 49. Bareback Equitation 13-15
- 50. Bareback Equitation 12 & Under
- 51. Bareback Equitation W/T 20 & Over
- 52. Bareback Equitation W/T 13-19
- 53. Bareback Equitation W/T 12 & Under
- *54. Disciplined Rail 19 & Over - Any Seat
- *55. Disciplined Rail 18 & Under- Any Seat
- *56. Ranch Pleasure 19 & Over
- *57. Ranch Pleasure 18 & Under
- *58. Ranch Riding Pattern 19 & Over (June 28 only)
- *59. Ranch Riding Pattern 18 & Under (June 28 only)
- *60. Reining Pattern 19 & Over (July 26 only)
- *61. Reining Pattern 18 & Under (July 26 only)
- *62. Trail Class 19 & Over (September 20 only)
(a. in hand, b. W/T, C. W/T/C)
- *63. Trail Class 18 & Under (September 20 only)
(a. in hand, b. W/T, C. W/T/C)

**BARRY COUNTY FAIRGROUNDS
AND PERSONS CONNECTED TO THIS SHOW ARE NOT
LIABLE FOR INJURY, DAMAGE OR LOSS.**

UNDER THE MICHIGAN EQUINE LIABILITY ACT, AN EQUINE PROFESSIONAL IS NOT LIABLE FOR AN INJURY OR DEATH, OF A PARTICIPANT IN AN EQUINE ACTIVITY RESULTING FROM AN INHERENT RISK OF THE EQUINE ACTIVITY.

Riders ages as of January 1, 2025.

Judge's decision is final.

NO REFUNDS. 4-H RULES.

Negative Coggins required.

Absolutely NO alcohol, improper language, or mind altering substance use by anyone in attendance!

Legal action will be taken and you will be asked to leave.

Show clothes are not required for the show. Casual dress, boots with a heel & helmets are required 19 & under for English and Bareback riding. Crop tops are NOT allowed.

- W/Trot exhibitors may not show in walk/trot/canter classes.
- DAILY HIGH POINT WILL NOT INCLUDED STAR* CLASSES
- PERFORMANCE SERIES HIGH POINT: WILL INCLUDE: disciplined rail, ranch pleasure, ranch riding patterns, reining & trail.
- SERIES HIGH POINT FOR HALTER will be awarded at end of series.
- STAKES CLASSES: will have payback of 1st place 30%, 2nd place 20%, 3rd place 10%.
- SERIES HIGH POINT will be based on the same horse and rider throughout the series.
- Follow our Facebook page for judges and prize updates!
- Please clean up after yourselves and your horses. There is a manure pit located at the end of the horse barn. Also don't forget your campground area.
- If spending the night Horses must have a stall. And stalls Must be cleaned prior to leaving.
- NO HORSES ALLOWED IN CAMPGROUND!
- EWD welcome.
- PRE REGISTRATION AVAILABLE.





2025 BARRY COUNTY UNDER THE LIGHTS SPEED SERIES

Daily &
Series High Point
Winners!

RAIN
OR
SHINE!

BARRY COUNTY FAIRGROUNDS 1350 M-37, Hastings MI 49058
Contact: Melissa Hubert (616) 206-9774

DATES:
JUNE 27
JULY 25
SEPTEMBER 19

Office fee: \$5 per horse & rider
Regular classes: \$5 /each
Jackpot classes: \$10 / each
Daily high point: \$6 / day
Series high point: \$25 one - time fee
NO REFUNDS!

Events

Age Groups

8 & under
9 - 14
15 - 19
20 & over

Jackpot Barrels
Barrels
Event 1
Jackpot Poles
Poles
Event 2

EVENTS 1 and 2
will be
drawn the day
before and
posted on our
Facebook page!

\$3.00 barrel expos
from 5:30 pm
to 6:30 pm
Show starts at 7 pm

- Rider has the option to roll over times from jackpot to age division class. Rider must tell the office when they sign up if they are rolling their times.
- **NO hitting your horse in front of the saddle or you will be DISQUALIFIED!**
- **NO running out of the gate or you will be DISQUALIFIED!**
- Daily and series high point will include all classes except jackpot classes.
- If there is a tie for daily high point, it will be decided by number of first places. If there is still a tie then it will be decided by fastest barrel times.
- Jackpot classes will have a payback of 1st place 30%, 2nd place 20%, 3rd place 10%.
- Series high point will be based on the same horse and rider throughout the series.
- Please clean up after yourselves and your horses. There is a manure pit located at the end of the horse barn. Also don't forget your campground area. If spending the night horses must have a stall. Stalls **MUST** be cleaned prior to leaving.
- ****NO HORSES ALLOWED IN CAMPGROUND!****
- EWD welcome.
- **PRE REGISTRATION AVAILABLE.**

Adult(s) assisting 8 and under riders **MUST** wear boots.
Show clothes are not required for the show.
Casual dress, boots with a heel & helmets are required for 19 and under
Crop tops are **NOT** allowed.

Riders ages as of January 1, 2025.
Judges decision is final.
4-H RULES.
Negative Coggins required.
ABSOLUTELY NO ALCOHOL, IMPROPER LANGUAGE, OR MIND ALTERING SUBSTANCE USE BY ANYONE IN ATTENDANCE!
Legal action will be taken and you will be asked to leave.



FAIR SCHEDULE

Monday 9 AM start Ring 1

1. Showmanship 17 & up
2. Showmanship 15 & 16
3. Showmanship 13 & 14

Showmanship Championships & Awards*

11. Fine Horse Halter
12. Color Halter
15. Pony Halter

Halter Championships*

96. Reining 12 & under
97. Reining 13 & over

Speed

70. Pole Bending Novice all ages
71. Pole Bending Novice Int
80. Pole Bending 9-12
81. Pole Bending 13 15 & 2.
- ~~Pole Bending 16 & over~~
72. Keyhole. Novice all ages.
- 73 Keyhole Novice Int
83. Keyhole 9-12
84. ~~Keyhole 13-15~~
85. Keyhole 16 & over
74. Speed & Action Novice all ages
75. Speed & Action Nov Int all ages
86. ~~Speed & Action 9-12~~
87. Speed & Action 13-15
88. ~~Speed & Action 16 & over~~
136. Speed & Action Driving all ages

Ring 2

4. Showmanship 11 & 12
5. Showmanship 9 & 10
6. Showmanship Novice
7. Showmanship Novice Int
8. Showmanship W/T

13. Registered Stock Type Halter
14. Grade Halter

102. Versatility
112. Novice & Novice Int
113. Trail 12 & under
114. Trail. 13 & over
134. Trail driving all ages

Jumping

130. Beginning Hunter Hack
131. Hunter Hack 18 inches
132. Hunter Hack 2 ft
133. Hunter Hack 2 ft 6 inches

**Tuesday 9 AM
Start Ring 1**

Western

- 42. Horsemanship 17 & over
- 43. Horsemanship 15 & 16
- 44. Horsemanship 13 & 14

- 48. Horsemanship Pony 13 & over
- 50. Pleasure Stock Type 13 & over
- 52. Pleasure Fine Type 13 & over
- 54. Pleasure Pony 13 & over

Western Championships

Seniors*

- 68. Speed Horsemanship Novice all ages
- 69. Speed Horsemanship Novice Int

- 55. Speed Horsemanship 9; 12
- 56. Speed Horsemanship. 13-15
- 57. Speed Horsemanship 16 & over

Speed

- 76. Cloverleaf Novice all ages 77
- . Cloverleaf Novice Int
- 89. Cloverleaf 9-12
- 90. Cloverleaf 13-15
- 91. Cloverleaf 16 & over

- 137. Cloverleaf Driving

- 78. Indiana Flag Novice all ages
- 79. Indiana Flag Nov Int

- 92. Indiana Flag 12 & under
- 93. Indiana Flag 13-15
- 94. Indiana Flag 16 & over

speed Championships Senior*
Speed Championships Junior*

Ring 2

Western

- 45. Horsemanship 11 & 12
- 46. Horsemanship 9 & 10
- 47. Horsemanship Pony 12 & under
- 34. Horsemanship 2-5 YO horse/pony
- 58. Horsemanship *WIT* all ages
- 64. Horsemanship Novice all ages
- 65. Horsemanship Nov Int
- 138. Driving Reinsmanship all ages

- 49. Pleasure Stock Type 12 & under
- 51. Pleasure Fine Type 12 & under
- 53. Pleasure Pony 12 & under
- 35. Pleasure 2-5 YO horse/pony
- 59. Pleasure *W/T* all ages
- 66. Pleasure Novice all ages
- 67. Pleasure Novice Int
- 139. Driving Pleasure all ages

Western Championships Juniors*

- 103. Bareback Equitation 12 & under
- 104. Bareback Equitation 13 & over
- 135. Driving Pattern
- 111. Walk Trot pattern **-Either Seat**
- 98. Ranch Horse 12 & under
- 99. Ranch Horse 13 & over
- 106. Basic Riding 1 (13 & over)
- 107. Basic Riding 1 (12 & under)
- 108. Basic Riding 2 (ages)
- 109. Basic Riding 3 (all ages)

FAIR Schedule

Wednesday 9 AM Start

Ring 1

**Tack change time allowed
before Hunt Seat starts**

Hunt Seat

- 23. Hunt Seat Eq 16 & over
- 24. Hunt Seat Eq 13-15
- 26. Hunt Seat Eq Pony 13 & over
- 28. Hunt Seat Pleasure 16 & over
- 29. Hunt Seat Pleasure 13-15
- 31. Hunt Seat Pleasure Pony 13 & over
- 21. Dressage Seat Eq 13 & over

English Championship Senior*

- 101. Suitability for Dressage 13 & over

Ring 3

Dressage

- 120. Introductory Level, Test A
- 121. Introductory Level, Tests
- 122. Introductory Level, Test C
- 123. Training Level, Test 1
- 124. Training Level Test 2
- 125. Training Level Test 3
- 126. First Level, Test 1
- 127. First Level Test 2

Ring 1

- Driving Championship*
- Performance Championship*
- Novice Championship*
- Overall Grand Championship*

Ring 2

Saddle Seat

- 36. Saddle Seat Equitation all ages
- 37. Saddle Seat Pleasure all ages

Hunt Seat

- 22. Hunt Seat Eq 12 & under
- 25. Hunt Seat Eq 12 & under Pony
- 32. Hunt Seat Eq 2-5 YO horse
- 151. Walk Trot Hunt Seat Equitation
- 60. Hunt Seat Eq Novice
- 61. Hunt Seat Eq Novice Int
- 27. Hunt Seat Pleasure 12 & under
- 30. Hunt Seat Pleasure 12 & under Pony
- 33. Hunt Seat Pleasure 2-5 YO horse
- 150. Walk Trot Hunt Seat Pleasure
- 62. Hunt Seat Pleasure Novice
- 63. Hunt Seat Pleasure Novice Int
- 20. Dressage Seat Eq 12 & under

English Championship Junior

- 100. Suitability for Dressage 12 & under
- 105. English/Western Riding all ages
- 115. Green Horse English/Western Riding all ages

***Showmanship Championship**

Is for 1st, 2nd & 3rd place finishers in classes:

Sr Championship=classes 1-3

Jr championship= classes 4 & 5

*Novice, Novice Intermediate, WT championship=classes 6,7, & 8

***Halter Championship**

Is for 1st and 2nd place finishers in classes: 11-15

***Western Championship**

Is for 1st and 2nd place finishers in the Western Horsemanship and Pleasure classes. 13 and over are Senior, 12 and under are junior. Pony classes included.

***Speed Championship**

Is for 1st and 2nd place finishers in classes: 80-94.

13 and over are Senior, 12 and under are Junior.

***English Championship**

Is for 1st and 2nd place finishers in the English Eq and Pleasure classes.

13 and over is Senior, 12 and under is Junior. Pony classes included.

***Driving Championship**

Is for 1st and 2nd place finishers in classes: 134-139

***Performance Championship**

Is for 1st and 2nd place finishers in classes: 96-99, 100-109, 111-115, 120-127 & 130-133

***Novice and Novice Intermediate**

Have their own championship class that will run on Wednesday, 1st or 2nd place in any Novice riding class. Walk/ Trot NOT eligible.

***Overall Grand Championship**

Will be run after all classes are completed. Must be a Grand or Reserve Champion from any of the other Championship classes to participate. Novice, Novice Int, Walk/Trot, and Driving NOT eligible. Championship class patterns will NOT be available until all classes are done. All participants will be given 15 minutes to study patterns. No patterns will be allowed in the ring. ALL championship classes are double judged.



Thursday

9:00 AM- State and High Point Questions at the Entry Booth (all ages)

10:00 AM- Young Clovers

- 9. Showmanship 5-6 year olds
- 10. Showmanship 7-8 year olds
- 140. 5-8 YO leadline horsemanship (all seats)
- 141. 7-8 YO horsemanship walk/trot (all seats)
- 142. 5-8 YO leadline pleasure (all seats)
- 143. 7-8 YO pleasure walk/trot (all seats)
- 1211. 5-8 YO fun class (all seats)
- 1212. 5-8 YO leadline pattern class (all seats)
- 1213. 7-8 YO pattern class

7:00 PM- Team Competition Ring 1

Friday

10:00 AM- Possible Fun and Games weather and volunteer permitting. Casual dress, but pants, boots and helmet required.

Saturday

Possible NBHA barrel show. 4h participants must wear pants, boots and helmets per 4H rules.



4-H Horse Project Community Service Form

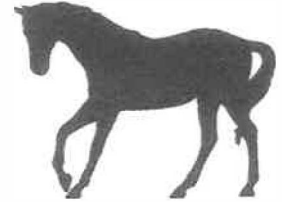

Name _____

4-H Club _____

Date of Project _____ Number of Hours _____

Location _____

Describe the project. Include what it accomplished and how it made you feel. Use the back of this form if needed.

4-H Leader

Project Mentor

Any 4-H Horse member may participate in a Community Service Project. A good project is worth 10 points towards the State 4-H Horse Show.

The project must meet the following criteria:

- **The project must benefit people outside of family members**
- **The Community Service may be done as a club or individual, be at least 2 hours long and be approved by your 4-H Leader prior to beginning the project.**
- **The project must be completed during the 4-H Calendar year. This form must be turned into your 4-H Leader prior to the first Show.**
- **If you need ideas for projects contact your 4-H Leader or contact the Extension Office.**

Member Name _____
Club Name _____

Shot Form

Horse Name on the
 Coggins: _____

Preferred Name for
 shows: _____

**The following shots are
REQUIRED by APRIL 30**

Negative Coggins, Eastern and Western Sleeping Sickness vaccinations;
 Rhino and Influenza vaccinations, Tetanus shot

Staple proof (receipt) of shots and Coggins to this form

Leader's initial Verifying proof of shots	Date of Shot	Name of Vaccine
		Eastern Sleeping Sickness (E E. Eastern Encephalomyelitis) (1)
		Western Sleeping Sickness (WE, Western Encephalomyelitis) (2)
		Tetanus (3)
		Rhino (4)
		Influenza (5)
		Or- 5 way (EE, WE, Tetanus, Rhino, Influenza)

Sponsor Form

The form on the back of this page is for Clubs and individuals who are willing to ask for sponsorships from businesses, individuals, or organizations to help support the Horse Program.

A fund raiser form must first be on file before Sponsorships are sought out. The Horse Council applies for such funding for the fiscal year so you may have someone who wishes to sponsor our horse shows which is where most of our funding comes from. The shows are also used as an educational opportunity. We purchase not only the prizes for these shows, but for Fair which our members are not charged to show at. Costs involved in putting on a show include Judges, ribbons, trophies or prize, and supplies used to put on the shows. These costs go up each year. This year paper supplies almost doubled in price.

Thank you for your help in funding our projects thru the Horse Program.

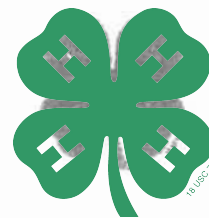

Barry County 4-H Horse Clubs Sponsorship

The Barry County Horse Developmental Committee would like to thank you for your generous donation to support our 4-H youth Horse program. Proceeds from the horse shows goes towards fulfilling the objectives of the 4-H club or 4-H Horse Developmental Committee Sponsoring the horse show. This may include but is not limited to: supplies, postage, horse council membership, scholarship, workshops/clinics, exhibition/fair trophies, show ribbons, awards, insurance, recognition, acts of compassion.

___ Gold Sponsors: - \$100.00 and over - A banner will be displayed if you have one for us to hang and your name on the show bills, and on a poster board displayed at events

___ Silver Sponsors - \$99.00 and under - Name on Show bills and on the Poster board displayed at events

Sponsor: _____

Amount: _____

SIGNED: _____

Retain this portion for 4H Accounting purposes

SPONSOR: _____

ADDRESS: _____

PHONE: _____

AMOUNT: \$ _____

CLUB & MEMBER Receiving Sponsorship: _____

Barry County Team Competition Registration

Team competition is an event that occurs on Thursday evening of the fair at 7pm. It is open to all horse 4H members who are in walk/trot/canter classes. All clubs will be mixed up and teams of 4 will be created to participate in 4 classes, **English, Western, Reining and Barrels. (Reining can be in costume and set to music)**

There will be a mandatory meeting on Sunday night at 7pm at the announcers stand to go over rules and late registrations(Late registration will not be guaranteed). At 9pm you will get your team assignments and determine your classes.

Cost is \$20 per participant and an additional \$10 if you would like at-shirt. Show clothes are casual(Long pants and appropriate footwear required), most choose to wear the competition t-shirt.

Please fill out the information below and turn in with payment at one of the point shows or to any Sundance rider leader before fair. **If you can't get to the points shows, please text or email a picture of your form to the contacts below.**

Name_____

Age_____

Club_____

Phone number_____

Class choice 1_____

Class choice 2_____

*You are not guaranteed your class choices, but we do our best!

Shirt size (if you choose to purchase) S, M, L, XL

Questions or form submission can be texted or emailed to:
Melissa Hubert 616.206.9774 or mshubert79@gmail.com
April Rogers 616.293.2830 or buckandannie@yahoo.com

REVISED 2025

Senior Pre-registration Form

Select 9 classes and 1 showmanship class (mandatory for fair)

Back # if you had one last year

SHOWMANSHIP – Required for fair		SPEED	
1	17 & Over Showmanship (Look for ring assignments)	81	Pole Bending 13 to 15
2	15 & 16 Showmanship (Look for ring assignments)	82	Pole Bending 16 & over
3	13 & 14 Showmanship (Look for ring assignments)	84	Key Hole 13 to 15
		85	Key Hole 16 & over
		87	Speed & Action 13 to 15
		88	Speed & Action 16 & over
HALTER – Only one may be selected (Look for ring assignments)		90	Clover Leaf 13 to 15
11	Fine Horse Halter	91	Clover Leaf 16 & over
12	Color Halter (50% Color, 50% Conformation)	93	Indian Flag Race 13 to 15
13	Registered Stock Type Halter	94	Indian Flag Race 16 & over
14	Grade Horse Halter		
15	Pony Halter		
ENGLISH		JUMPING (Only 2 classes allowed - except Cross Poles)	
36	Saddle Seat Equitation, All Ages	130	Hunter Hack, Cross Poles, May Not show in another Hunter Hack Classes
37	Saddle Seat Pleasure, All Ages	131	Hunter Hack 18 Inches
23	16 and Over Hunt Seat Equitation	132	Hunter Hack 2 Foot
24	13 - 15 Hunt Seat Equitation	133	Hunter Hack 2 Foot 6 Inches
32	2,3,4,5 yr old Hunt Seat Equitation, All Ages		
21	Dressage Equitation, 13 and Over		
26	Hunt Seat Equitation Pony 13 and Over		
28	16 and Over Hunt Seat Pleasure	MISC PERFORMANCE –	
29	13 - 15 Hunt Seat Pleasure	97	Reining, 13 and over
33	2,3,4,5 yr old Hunt Seat Pleasure, All Ages (Ring 1)	99	Ranch Horse Riding 13 and Over
31	Pony Hunt Seat Pleasure, 13 and Over	102	Variety Horse and Pony, All Ages
		104	Bareback Equitation, 13 and Over, All Seats
		101	Suitability for Dressage 13 and Over
		114	Trail, 13 and Over (Western or English)
WESTERN		105	English / Western Riding
42	17 & Over Horsemanship	115	Green English/Western Riding
43	15 & 16 Horsemanship	106	Basic Riding 1, 13 and Over
44	13 & 14 Horsemanship	108	Basic Riding 2
34	2,3,4,5 yr old Western Horsemanship, All Ages (Ring 1)	109	Basic Riding 3
48	13 and Over Pony Western Horsemanship		
56	13 to 15 Speed Horsemanship (you must compete in 3 speed classes)		
57	16 & Over Speed Horsemanship (must compete in 3 speed classes)		
50	13 and Over Stock Type Pleasure	DRIVING	
52	13 and Over Fine Type Pleasure (Arabian, Morgan, TB, Gaited, etc.)	138	Driving Reinmanship, All ages
35	2,3,4,5 yr old Western Pleasure, All Ages, (Ring 1)	139	Driving Pleasure, All ages
54	13 and Over Pony Pleasure	135	Driving Pattern
		136	Speed and Action, Driving, All Ages
		137	Cloverleaf, Driving, All Ages
		134	Driving Trail
DRESSAGE - You may only show in 3 tests		*** TESTING will be run DURING YOUNG CLOVERS – ONLY	
120	Introductory Level, Test A	124	Training Level 1, Test 2
121	Introductory Level, Test B	125	Training Level 1, Test 3
122	Introductory Level, Test C	126	Level 1, Test 1 (Once successfully completed you may not go back to Training Level with same horse)
123	Training Level 1, Test 1	127	Level 1, Test 2

TURN IN ONE COPY TO YOUR LEADER IN APRIL WITH YOUR SHOT RECORDS AND COGGINS

KEEP A COPY FOR YOUR RECORDS AND BRING TO EACH POINT SHOW AND FAIR THAT YOU ATTEND



Exhibitor's Date of Birth	Exhibitor's Name	Exhibitor's Phone #
Exhibitor's Club	Horse's Name	Horse's Breed
Parent's Name	Email:	Revised 2025

Junior Pre-registration Form

Select 9 classes and 1 showmanship class (mandatory for fair)

SHOWMANSHIP – Mandatory for fair.		SPEED	
4	11 & 12 Showmanship		
5	9 & 10 Showmanship	80	Pole Bending, 9 to 12
HALTER - Only one halter class may be selected.		83	Key Hole, 9 to 12
11	Fine Horse Halter	86	Speed & Action, 9 to 12
12	Color Halter (50% Color, 50% Conformation)	89	Clover Leaf, 9 to 12
13	Registered Stock Type Halter	92	Indian Flag Race, 9 to 12
14	Grade Horse Halter		
15	Pony Halter		
ENGLISH			
36	Saddle Seat Equitation, All ages, (Ring 1)		
37	Saddle Seat Pleasure, All ages, (Ring 1)		
22	Hunt Seat Equitation -12 and Under	130	Hunter Hack Cross Poles, May not show in another Hunter Hack Class
25	Hunt Seat Equitation, Pony, 12 and Under	131	Hunter Hack, 18 inches
20	Dressage Equitation 12 and Under	132	Hunter Hack, 2 foot
32	2,3,4,5 yr old Hunt Seat Equitation, All Ages (Ring 1)	133	Hunter Hack, 2 foot 6 inches
		JUMPING (Only 2 classes allowed - except Cross Poles)	
27	Hunt Seat Pleasure, 12 and Under	96	12 and Under Reining
30	Hunt Seat Pleasure, Pony 12 and Under	98	Ranch Horse Riding 12 and Under
33	2,3,4,5 yr old Hunt Seat Pleasure, All Ages (Ring 1)	102	Versatility, Horse and Pony, All Ages
		103	Bareback Equitation, 12 and Under, All Seats
		100	Suitability for Dressage 12 and Under
		113	Trail 12 and Under (Western or English)
WESTERN			
45	11 & 12 Horsemanship		
46	9 & 10 Horsemanship		
47	12 and Under Pony Horsemanship	115	Green English/Western Riding
34	2,3,4,5 yr old Western Horsemanship, All Ages (Ring 1)	105	English / Western Riding
		107	Basic Riding 1, 12 and Under
55	9 to 12 Speed Horsemanship (you must compete in 3 speed classes)	108	Basic Riding 2
		109	Basic Riding 3
49	12 and Under Stock Type Pleasure	DRIVING	
51	12 and Under Fine Type Pleasure (Arabs, Morgan, TB, Gaited, etc.)	138	Driving Reinsmanship, All ages
53	12 and Under Pony Pleasure	139	Driving Pleasure, All ages
35	2,3,4,5 yr old Western Pleasure, All Ages (Ring 1)	135	Driving Pattern
		136	Driving, Speed & Action, All Ages
		137	Driving, Cloverleaf, All Ages
		134	Driving, Trail, All Ages
DRESSAGE -- You may only show in 3 tests. *** TESTING will be run DURING YOUNG CLOVERS – ONLY ***			
120	Introductory Level, Test A	124	Training Level, Test 2
121	Introductory Level, Test B	125	Training Level, Test 3
122	Introductory Level, Test C	126	Level 1, Test 1 (Once successfully completed you may not go back to Training Level)
123	Training Level, Test 1	127	Level 1, Test 2

TURN IN ONE COPY TO YOUR LEADER AT YOUR APRIL MEETING.

KEEP A COPY FOR YOUR RECORDS AND BRING TO EACH POINT SHOW AND FAIR



Exhibitor's Date of Birth	Exhibitor's Name and Back # from last year if you have	Exhibitor's Phone #
Exhibitor's Club	Horse's Name	Horse's Breed
Parent's Name	Email:	Revised 2025

Novice Pre-registration form Select 9 classes and 1 showmanship class (mandatory for fair)

6	Showmanship, Novice	70	Pole Bending, Novice, All Ages
7	Showmanship, Intermediate Novice	71	Pole Bending, Intermediate Novice
	Check at show for Ring assignments	72	Key Hole, Novice, All Ages
		73	Key Hole, Intermediate Novice, All Ages
		74	Speed & Action, Novice, All Ages
HALTER – Only, one may be selected (Look for ring assignments)			
11	Fine Horse Halter	75	Speed & Action, Intermediate Novice
12	Color Halter (50% Color, 50% Conformation)	76	Clover Leaf, Novice, All Ages
13	Registered Stock Type Halter	77	Clover Leaf, Intermediate Novice
14	Grade Horse Halter	78	Indian Flag Race, Novice, All Ages
15	Pony Halter	79	Indian Flag Race, Intermediate Novice
ENGLISH			
60	Novice English Equitation, All Ages		
61	Intermediate Novice English Equitation, All Ages		
62	Novice English Pleasure, All Ages		
63	Intermediate Novice English Pleasure, All Ages		
MISC PERFORMANCE			
		112	Trail Novice, Intermediate Novice
WESTERN			
64	Western Horsemanship, Novice, All Ages		
65	Western Horsemanship, Intermediate Novice, All Ages		
66	Western Pleasure, Novice, All Ages		
67	Western Pleasure, Intermediate Novice, All Ages		
	MUST SHOW 3 SPEED CLASSES TO BE ELIGIBLE FOR 68 or 69		
68	Novice Speed Horsemanship, All Ages		
69	Intermediate Novice Speed Horsemanship, All Ages		

TURN IN ONE COPY TO YOUR LEADER IN APRIL WITH YOUR SHOT RECORDS AND COGGINS

KEEP A COPY FOR YOUR RECORDS AND BRING TO EACH POINT SHOW AND FAIR THAT YOU ATTEND

MICHIGAN STATE UNIVERSITY | Extension



Exhibitor's Date of Birth	Exhibitor's Name	Back # if you have one from last year	Exhibitor's Phone #
Exhibitor's Club	Horse's Name	Horse's Breed	
Parent's Name	Email	Revised 2025	

MICHIGAN STATE UNIVERSITY

Extension

Barry County

DUE TO AGE CHANGES IN 4H PROGRAM 8 YEAR OLDS ARE NOW REGULAR 4HERS NOT YOUNG CLOVERS BUT DUE TO OUR FAIR AGES NOT CHANGING WE ARE OFFERING 8 YEAR ONLY WALK/TROT/CANTER CLASSES AT THE POINT SHOWS. AT FAIR 8 YEAR OLDS WILL HAVE TO SHOW ON THURSDAY ONLY AS YOUNG CLOVERS. If you feel you are not ready to canter you may continue to show even at Point Shows a Young Clover. Talk to your leader if you are confused on this. *Please put Back # down if you have one from last year.

Young Clover		Showmanship is mandatory for fair	
9	Showmanship 5-6 (Required for fair)	141	7-8 Horsemanship Walk/Trot (All seats)
10	Showmanship 7-8 (Required for fair)	143	7-8 Pleasure Walk/Trot (All seats)
140	5-8 Lead Line Horsemanship (All seats)		Other classes will be added for Fair
142	5-8 Lead Line Pleasure (All seats)		

8 YEAR OLD WALK /TROT/CANTER		Showmanship is mandatory for fair	
144	Showmanship 8 Year Olds	148	Pattern (All seats) 8 Year Olds
145	Halter - All Breeds	149	Cloverleaf
146	Horsemanship (All seats) 8 Year Olds		None of these classes will be offered at fair
147	Pleasure (All seats) 8 Year Olds		

Walk/Trot Use this section if your child is only able to Walk/Trot Ages 9 and up.	
8	Walk/Trot Beginning Showmanship. Mandatory for fair.
Halter- Only one halter class may be selected	
11	Fine Horse Halter
12	Color Halter (50% Color, 50% Conformation)
13	Registered Stock Type Halter
14	Grade Horse Halter
15	Pony Halter
<p>TURN IN A COPY TO YOUR LEADER IN APRIL WITH YOUR SHOTS AND COGGINS FORMS.</p> <p>KEEP A COPY FOR YOUR RECORDS AND BRING TO EACH POINT SHOW AND FAIR.</p>	
WESTERN	
58	Walk/Trot Horsemanship (May not show many canter classes)
59	Walk/Trot Pleasure (May not show in any canter classes)
ENGLISH	
148	Walk/Trot Hunt Seat Equitation (May not show many canter classes)
149	Walk/Trot Hunt Seat Pleasure (May not show many canter classes)
PERFORMANCE	
111	Walk/Trot Pattern, All ages (May not show in any canter classes)

Exhibitor's date of birth	Exhibitors Name & Back #
Exhibitor's Phone	Email:
Exhibitor's Club	Horse's Breed:
Horse's Name	<p>Young Clovers are only ones that can share a horse.</p> <p>IF SO- NAME OF RIDER- NAME OF CLUB-</p>
<p>IS THIS HORSE BEING USED BY ANOTHER RIDER?</p> <p>REVISED 2022</p>	

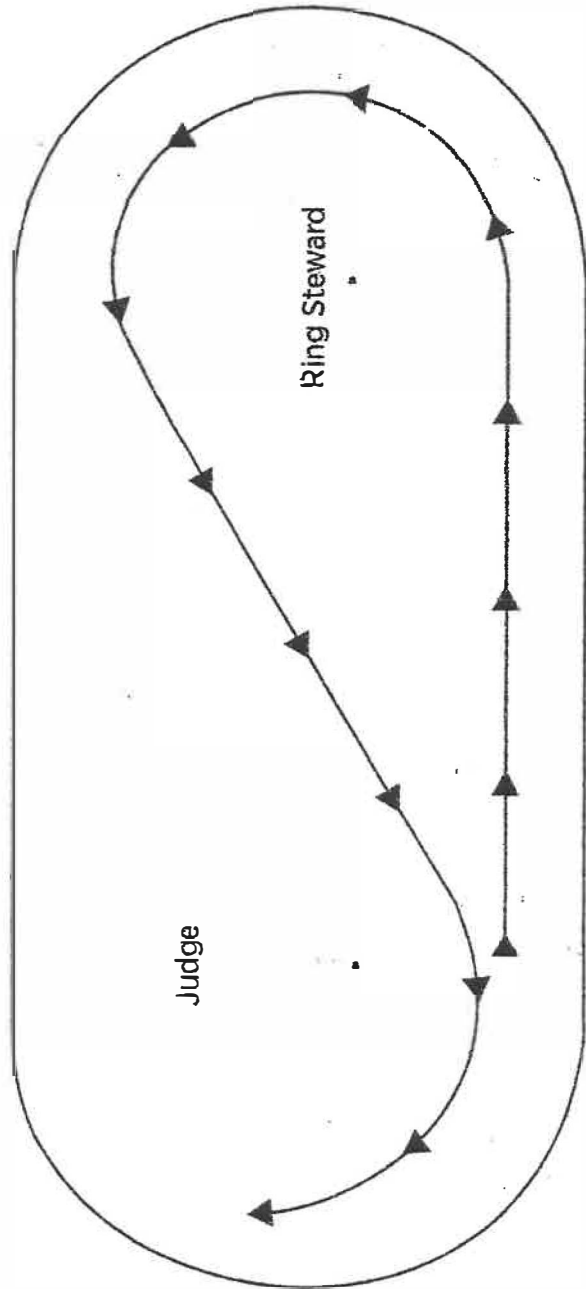

Figure 2. Reversing on the diagonal at the trot in draft horse pleasure driving.

Draft Horse Pleasure Driving Criteria	Points
Movement	60
The walk (10)	
The trot (30)	
Backing (20)	
Manners	20
Responsiveness	20
Total	100

CRITERIA EXPLANATION

MOVEMENT (60 points)

The Walk (10 points)

True, brisk and relaxed.

The Trot (30 points)

True, square, and brisk, but under full control at all times. Extreme speed will be penalized. Natural action is desirable.

Backing (20 points)

A smooth, collected and straight back.

MANNERS (20 points)

The horse should be quiet on the bit, under control and work willingly on command without being sour.

RESPONSIVENESS (20 points)

The horse should perform all transitions smoothly and willingly. The horse should back showing submission to the driver and in a straight line.

DRAFT HORSE DRIVING REINSMANSHIP

This class emphasizes the driver's ability to control his or her animal on the rail and through obstacles and other tests of driving ability. The class should be first divided into junior and senior exhibitors and then by breeds if there are enough entries.

APPOINTMENTS OF ANIMAL AND DRIVER - Appointments of animal, driver and assistant driver or groom are the same as for draft horse pleasure driving.

Draft Horse Pleasure Driving Criteria	Points
Cleanliness & condition of horse, harness & vehicle	25
Rail work	25
Driving pattern	50
Total	100

CRITERIA EXPLANATION

CLEANLINESS & CONDITION OF HORSE, HARNESS & VEHICLE (25 points)

Horse is properly fitted, groomed and conditioned with a clean, crisp appearance. Attention is paid to the cleanliness of harness

REINING DIVISION

“To rein a horse is not only to guide him, but also to control his every movement. The best reined horse should be willingly guided or controlled with little or no apparent resistance and dictated completely.” (*2000 National Reining Horse Association Pattern Book*)

APPOINTMENTS OF HORSE AND RIDER - See the “Western Appointments” section of the Western Riding Division. Skid boots, splint boots and protective leg wraps are optional in reining classes.

The judge will indicate the length of the pattern with markers on the arena fence or wall. Markers within the area of the pattern may be used as a guide, but circles, figure eights and other movements do not have to be performed within the markers.

REINING PATTERN 1

See figure 18 for a diagram of reining pattern 1.

1. Run with speed to the far end of the arena past the end marker and do a left rollback – no hesitation.
2. Run to the opposite end of the arena past the end marker and do a right rollback – no hesitation.
3. Run past the center marker and do a sliding stop. Back up to the center of the arena or at least 10 feet (3 meters). Hesitate.
4. Complete one spin to the right. Hesitate.
5. Complete one and one-quarter spins to the left so that the horse is facing the left wall or fence.
6. Beginning on the left lead, complete two circles to the left, with the first circle large and fast, and the second circle small and slow. Change leads at the center of the arena.
7. Complete two circles to the right, with the first circle large and fast, and the second circle small and slow. Change leads at the center of the arena.
8. Begin a large, fast circle to the left but do not close this circle. Run straight up the right side of the arena past the center marker and do a sliding stop at least 20 feet (6 meters) from the wall or fence. Hesitate to demonstrate you have completed the pattern.
9. Dismount and drop the bridle to the designated judge.

CRITERIA EXPLANATION

Judges are encouraged to score reining classes according to the NRHA scoring system, which states that all riders will enter the class with a score of 70, which represents an average run. (Scoresheets are available online at nrha.com/forms/judgesscorecard.pdf.) That score is added to or subtracted from as maneuvers are performed and penalties are added. Each maneuver should be scored according to the following scale:

-1½ = extremely poor

-1 = very poor

-½ = poor

0 = correct

+½ = good

+1 = very good

+1½ = excellent

Scoring will be on the basis of 60 to 80, with 70 representing an average performance.

The following will result in a disqualification from the class:

- Failure to complete the pattern as written.
- Equipment failure that delays completion of the pattern.
- Performing maneuvers other than in the specified order.
- Including maneuvers not specified, including but not limited to backing more than two strides (two strides meaning four steps with the front feet).
- A turn of more than 90 degrees where one is not specified.
- Running away or failure to guide where it becomes impossible to discern whether the entry is on pattern.
- Jogging in excess of one-half circle or one-half the arena while starting a circle, circling or exiting a rollback.
- Overspins of more than ¼-turn.
- Use of illegal equipment.
- Willful abuse of the horse.
- Using the reins or romal as a whip.
- Using more than one finger between reins.
- Changing hands on the reins.
- Using two hands on the reins (except with junior horses that are ridden two-handed, or that are shown in a bosal or snaffle bit).
- Fail to the ground by horse or rider.
- Balking or refusing a command.

The following will result in a 5-point reduction:

- Spurring in front of the cinch.
- Use of the free hand to instill fear.
- Holding the saddle or touching or petting the horse with the free hand.
- Blatant disobedience of the horse, including kicking, biting, bucking and rearing.

The following will result in a 2-point reduction:

- Failure to go beyond markers on stops or rollbacks when it is called for in the pattern.
- Break of gait.
- Freeze up in spin or rollbacks.
- On walk-in patterns, failure to stop or walk before executing a canter departure.
- On run-in patterns, failure to be in a canter before the first marker.
- Starting or performing circles out of lead will be judged as follows: Each time a horse is out of lead, a judge is required to deduct 1 point, which is cumulative. The judge will deduct 1 point for each quarter of the circumference of the circle or any part thereof that the horse is out of lead. The judge is required to deduct ½ point for a delayed change of lead by one stride.

Other faults and their penalties include:

- Starting a circle at a jog or exiting rollbacks at a jog up to two strides (½ point).
- Over- or under-spinning up to one-eighth of a turn (½ point).
- Failure to remain a minimum of 20 feet from the wall or fence when approaching a stop or rollback (½ point).
- Over- or under-spinning from one-eighth to one-quarter turn (1 point).
- Jogging beyond two strides, but less than one-half circle or one-half the length of the arena (2 points).
- When a change of lead is specified immediately before a run at the end of the arena, failure to change leads will be penalized as follows:
 - Failure to change leads by one stride (½ point).
 - Failure to change leads beyond one stride but completed before the next maneuver (1 point).

Lead Penalties*

- Each time a horse is out of lead, the judge is required to penalize it by 1 point. The penalty for being out of a lead is cumulative, and the judge will add 1 penalty point for each one-quarter circumference of a circle or any part thereof that a horse is out of lead. The judge is further required to penalize a horse ½ point for a lead change delayed by one stride where a change of lead is required by the pattern. **Note:** A gait is specified, but no lead is specified in the instance of run-downs either on the side of the arena or through the middle of the arena, and no penalty is incurred for a horse changing leads in these areas.
- In patterns where a horse is required to run around the end of arena, the horse must be on the correct lead while rounding the end of the arena. The horse is required to be on the specified lead as soon as it completes the first straight portion of the run-around and begins to turn the corner of the arena. Failure to be in the correct lead beyond this point will result in the following penalties:
 - From the turn to the halfway position at the end wall (-1 point).
 - Beyond the halfway point up to the beginning of the run-down (-2 points).
 - It should be noted NRHA has determined there to be no correct lead on a straight line. Therefore, changing leads in a straight line is not to be penalized, though it may or may not demonstrate resistance to being dictated to completely, which must be dealt with in maneuver evaluation.
- Where a pattern requires a half circle before beginning a run-down to the other end of the arena, a failure to be on a specified lead should be penalized as follows:
 - Beyond one stride up to one-quarter circumference of circle (1 point).
 - Beyond one-quarter circumference of circle up to the entire half circle (2 points).

*Lead Penalties adapted with permission from the 2014 *National Reining Horse Association Pattern Book*.

- Lead is not changed before next maneuver (2 points)

Faults against the horse to be scored at the judge's discretion, but not to cause disqualification:

- Opening mouth excessively (when the horse is shown in a bit).

- Excessive jawing, opening mouth or head raising on stop.
- Lack of smooth, straight stop on haunches, bouncing or sideways stop.
- Refusing to change leads.
- Anticipating signals.
- Stumbling.
- Backing sideways.
- Knocking over markers.

Faults against the rider to be scored accordingly, but not to cause disqualification:

- Losing a stirrup.
- Any unnecessary aid given by the rider (such as talking, spurring, quirting or jerking of reins). **Note:** If this is deemed excessive by the judge, it may fall under "willful abuse of the horse" and result in disqualification.
- Failure to go beyond markers on rollbacks and stops is considered a fault. Failure to run circles or figures eights within the markers is not considered a fault, depending on arena conditions and size.

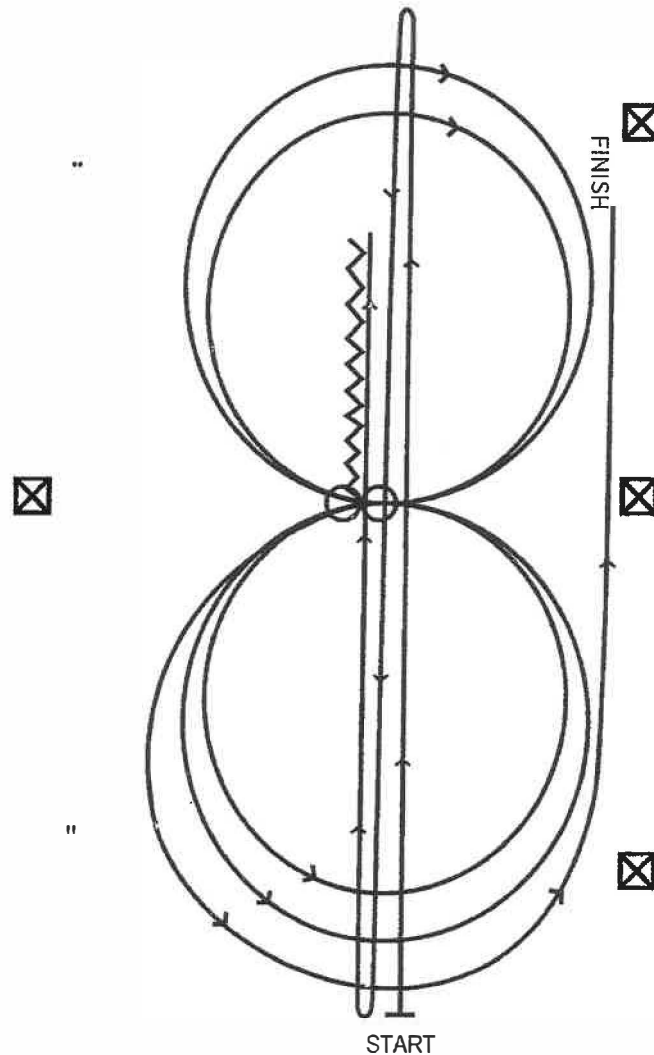

Figure 18 Reining pattern 1

REINING PATTERN 2

Exhibitors may walk or trot their horses to the center of the arena. Horses must walk or stop before starting the pattern. Begin at the center of the arena facing the left wall or fence. (See fig. 19 for a diagram of reining pattern 2.)

1. Complete one spin to the right. Hesitate.
2. Complete one spin to the left. Hesitate.
3. Beginning on the left lead, complete two circles to the left, **with** the first circle large and fast, and the second circle small and slow. Change leads at the center of the arena.
4. Complete two circles to the right, with the first circle large and fast, and the second circle small and slow. Change leads at the center of the arena.

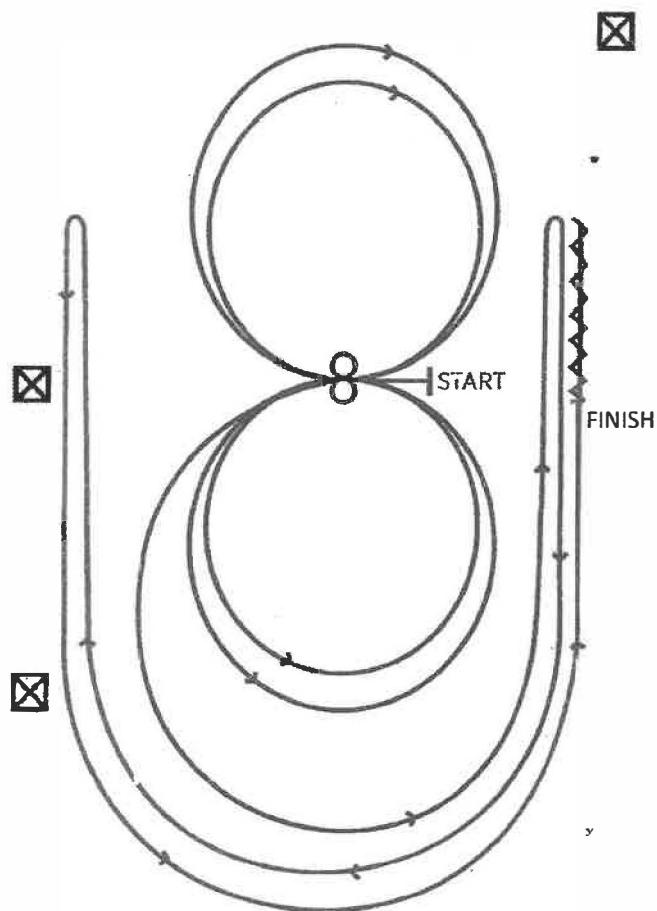

Figure 19. Reining pattern 2.

5. Begin a large fast circle to the left but do not close this circle. Run up the right side of the arena past the center marker and do a right rollback at least 20 feet (6 meters) from the wall or fence - no hesitation.
6. Continue back around the previous circle but do not close this circle. Run up the left side of the arena past the center marker and do a left rollback at least 20 feet (6 meters) from the wall or fence - no hesitation.
7. Continue back around previous circle but do not close this circle. Run up the right side of the arena past the center marker and do a sliding stop at least 20 feet (6 meters) from the wall or fence. Back up at least 10 feet (3 meters). Hesitate to demonstrate that you have completed the pattern.
8. Dismount and drop the bridle to the designated judge.

BASIC 1

NAME _____

DATE _____

WALK

TROT

CANTER

IMPRESSIONS	SCORE
RIDER (possible 0-15)	
HORSE (possible 0-15)	
OVERALL (possible 0-20)	
Judges Score _____	TOTAL IMPRESSIONS _____
	FINAL SCORE _____

Judges Signature _____

REMARKS: _____

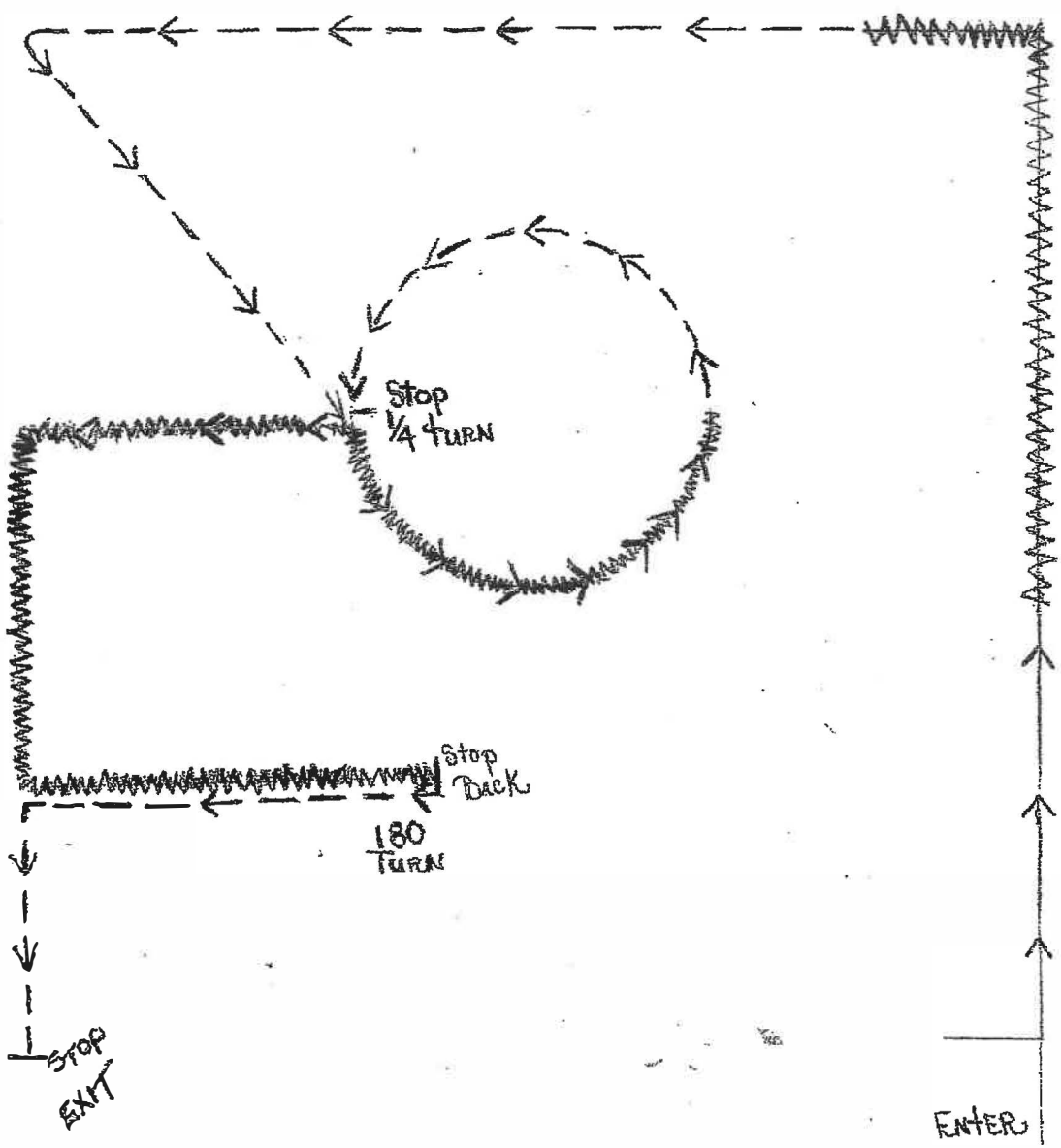

SCORE

- _____
- _____
- _____
- _____
- _____
- _____
- _____
- _____
- _____
- _____

DATE _____

BASIC II

Back # _____

IMPRESSIONS

SCORE

RIDER - 15 pts. - BASED ON USE OF AIDS (HANDS, SEAT, BACK & LEGS) RIDING IN BALANCE AND COORDINATION.

HORSE - 15 pts. - BASED ON ATTITUDE, OBEDIENCE, FREE MOVING GAITS, MOVING STRAIGHT, FLEXIBILITY, SMOOTH TRANSITION FROM ONE GAIT TO ANOTHER.

OVERALL - 20 pts. - BASED ON SUITABILITY OF HORSE TO RIDER. WORK TOGETHER AS A TEAM. PROPER ADJUSTMENT OF EQUIPMENT, CLEANLINESS AND NEATNESS.

Judges Score _____ Impression Score _____
Total Score _____

WALK

TROT

CANTER

Judges Signature _____ REMARKS: _____

Score

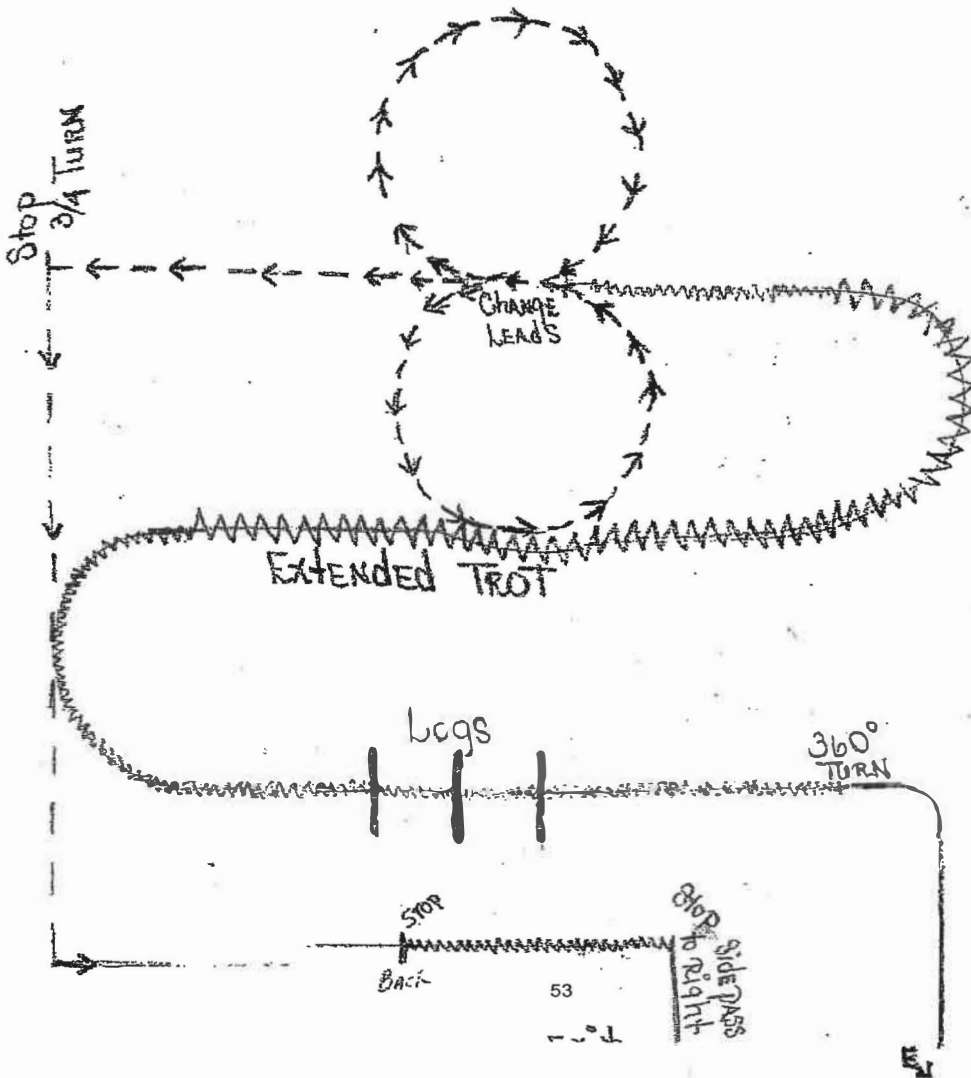

WALK – TROT PATTERN

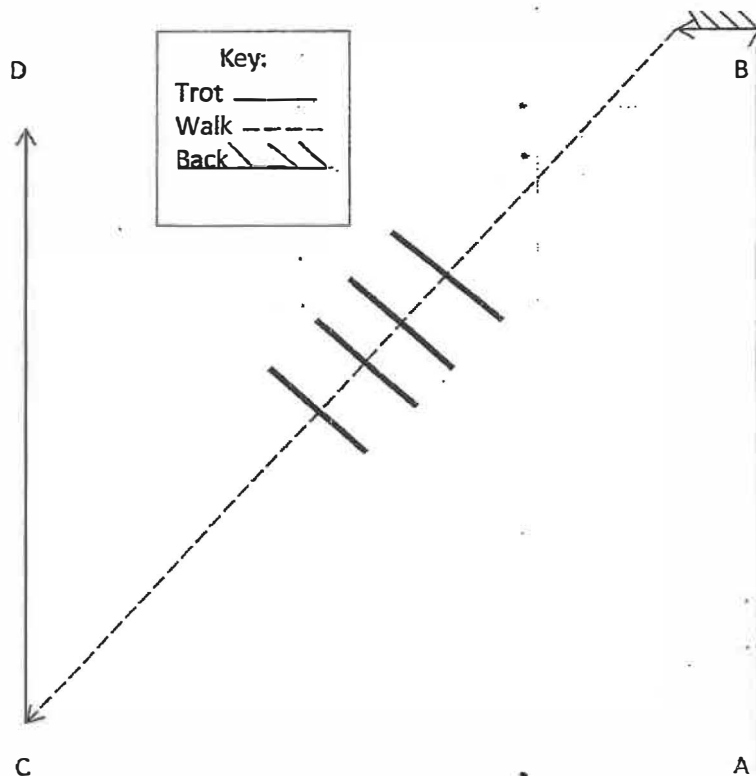

Instructions:

1. Start at A and trot around B
2. Stop and back 4 steps
3. Turn 45 degrees . Walk to C over the logs (Ground poles).
4. At C Stop and pivot 45 degrees
5. Trot to D
6. At D stop and wait to be dismissed.

Revised: 1/16/2011

Pattern #5

8 YEAR OLD WALK/TROT/CANTER PATTERN

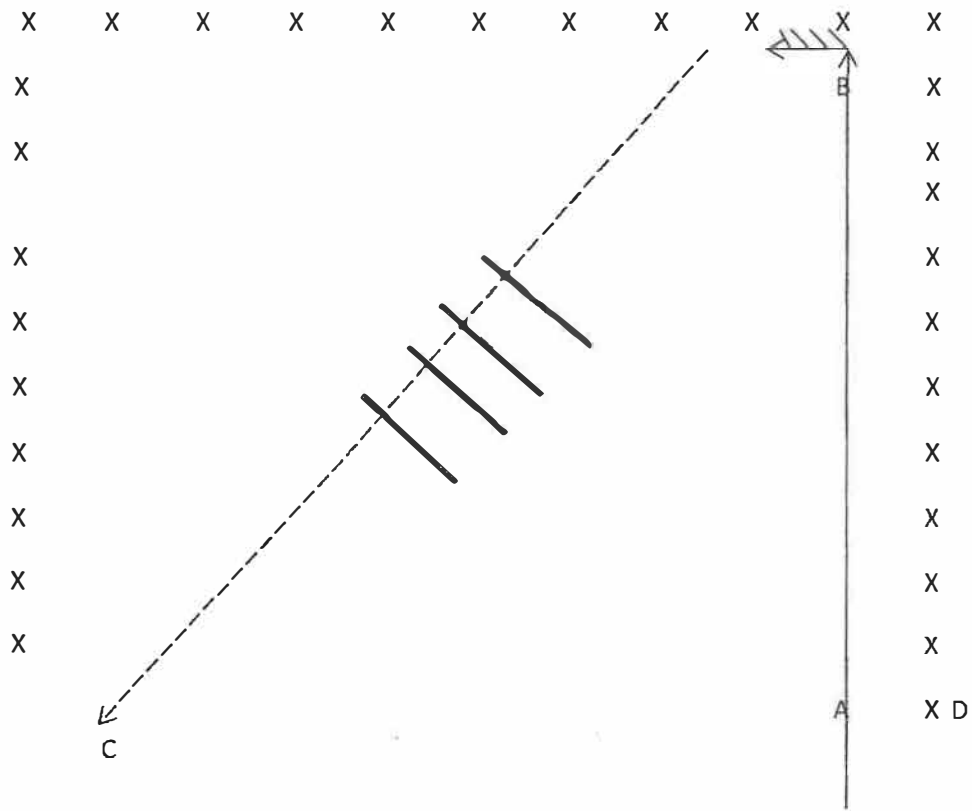

Instructions:

1. Start at A and trot around B _____
2. Stop and back 4 steps \\\
3. Turn 45 degrees . Walk to C over the logs (Ground poles). -----
4. At C Stop and pivot 45 degrees
5. Canter to D XXXXX
6. At D stop and wait to be dismissed.

REVISED 2025

No score (for a particular obstacle only):

- Negotiating an obstacle differently than is described on the pattern.
- Missing or not attempting an obstacle.
- Refusing, balking or attempting to evade an obstacle by shying or backing (third time).

ENGLISH/WESTERN RIDING CLASS

[English/western] riding is an event where the horse is judged on quality of gaits, lead changes at the lope or canter, response to the rider, manners and disposition. The horse should perform with reasonable speed, and be sensible, well-mannered, free and easy moving. (*AGHA Handbook of Rules and Regulations*)

HORSE'S PERFORMANCE AND MANNERS – Horses will be judged on the riding quality of gaits, changes of leads, response to the rider, manners and disposition. Preference will be given to complete flying changes of leads midway between the markers throughout the entire class. This indicates the control of a rider over his or her mount and encourages youth to train for the event.

A rider will be penalized for losing a stirrup, using two hands on the reins (except where two hands are permitted), changing hands on the reins (except when negotiating the gate) or touching any part of the saddle with the free hand. While the horse is in motion, the rider's hands should be clear of the horse and saddle.

APPOINTMENTS OF HORSE – Appointments of horse and rider should be consistent with the seat chosen, as described elsewhere in this book. Skid boots, splint boots and protective leg wraps are optional in English/western riding classes.

APPOINTMENTS OF RIDER – Appointments of horse and rider should be consistent with the seat chosen, as described in this book.

COURSE DESCRIPTION

Figure 20 illustrates the English/western riding course. The American Quarter Horse Association (AQHA) western riding pattern 2 is also acceptable; however, if it is to be used, copies of the pattern should be provided to judges and exhibitors well in advance of the class.

The eight small dots represent markers (cones or pylons are recommended). These should be separated by a uniform

distance of not less than 30 feet and no more than 50 feet. The distances may be altered if the local arena is too small.

1. The horse will be judged on quality of gaits, changes of lead, response to the rider, manners, disposition and intelligence.
2. The horse should maintain an even cadence and change leads precisely and easily, front and rear, at the center point between markers as indicated by the shaded areas on the pattern. The horse should have a relaxed head carriage showing its response to the rider's hands, with moderate flexion at the poll. The tail should remain quiet throughout the pattern. The horse should cross the log at the jog or pleasure gait and lope without breaking gait or radically changing stride.
3. Additional information about the pattern follows.
 - The arrows on the lines indicate the direction of travel and the type of line indicates the gait.
 - The log should be at least 8 feet long and laid on the ground.

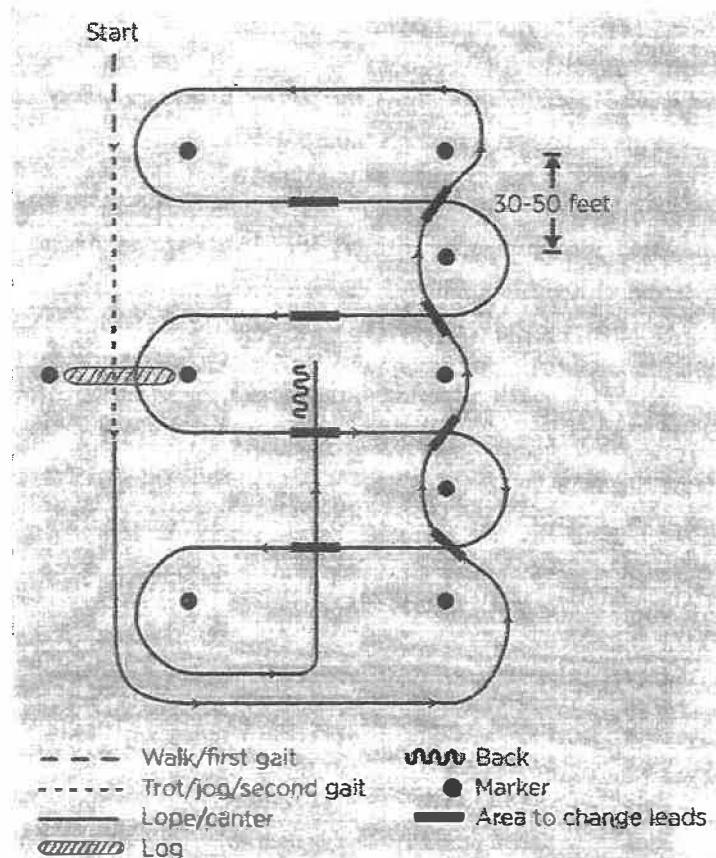

Figure 20. English/western riding pattern.

- The markers should be cones or pylons. In the row of five markers, the markers are separated by equal distances of 30 to 50 feet. The markers in the row of three are aligned with the first, third and fifth markers in the row of five.
- After stopping and backing at least 10 feet at the end of the pattern, the rider will report to the judge to be excused.
4. A horse going off pattern is disqualified. Off pattern is any of the following: an incomplete pattern, incorrect order of maneuvers, knocking over markers, passing on the wrong side of markers, making extra loops in the pattern, missing the log, five or more simple lead changes, and failure to change leads.
 5. The judge may require an exhibitor to repeat or reverse any part of the routine.
 6. Only one hand is allowed on the reins and only the index finger is allowed between the reins. Except when negotiating the gate, the hand on the rein cannot be changed. When roma reins are used they will be carried as described under "Stock Seat Equitation" in the Western Division.
 7. The running walk or other pleasure gait is acceptable for any horses that do not jog.
 8. Each rider will enter the ring with a score of 70, which represents an average performance. Final scores will generally fall in a range from 40 to 80 points.
 - **Scoring guidelines:** Points will be added or subtracted from the eight maneuvers on the following basis.
 - 1 = very poor
 - ½ = poor
 - 0 = correct
 - +½ = good
 - +1 = excellent
 - Sample scoresheets are available online from:
 - American Quarter Horse Association Resources at aqha.com/Resources - Scroll down to the "Score Sheets" section.
 - Appaloosa Horse Club Downloadable Forms at appaloosa.com/downloadable-forms.htm - Scroll down to "Judges Score Sheets" section.
 - The maneuvers are:
 - a. Trot over the log
 - b. Trot and transition to lope

- c. Line (side) lead changes (plus or minus 1 point per change)
- d. First two crossing lead changes (plus or minus 1 point per change)
- e. Lope over the log
- f. Second two crossing lead changes (plus or minus 1 point per change)
- g. Lope, stop and back a minimum of 10 feet
- An additional score of plus or minus 1 point will be given for pattern accuracy and smoothness.
- Contestants will be penalized as follows:
 - 5 points**
 - Failure to change leads where indicated in pattern.
 - 3 to 5 points**
 - Using the free hand to instill fear in or to praise the horse.
 - 3 points**
 - Breaking gait at a lope, including a simple lead change.
 - Making extra lead changes anywhere on the course.
 - Breaking gait at a walk or jog for two or more strides.
 - Failure to begin lope within 30 feet after crossing log.
 - 2 points**
 - Failing to take a prescribed gait at the designated point in the pattern.
 - Failing to change lead behind until the next change point.
 - 1 point**
 - Breaking gait at a walk or trot up to two strides.
 - Hitting the log.
 - ½ point**
 - Touching the log lightly.
 - Failing to change lead behind from one-half stride up to a cone.

Disqualifications – Failure to perform at least four flying lead changes will result in disqualification.

- The following are considered faults and should be penalized at the judge's discretion:

- Opening mouth excessively or throwing head on maneuvers.
- Anticipating signals or early lead changes.
- Stumbling.
- Losing a stirrup or holding on.
- Any unnecessary aid given by the rider, such as talking, petting, spurring, quirting or jerking the reins.

GREEN ENGLISH/WESTERN RIDING

This class will use the same rules, scorecard, scoring system, and evaluation criteria as English/western riding. Horses may perform simple lead changes without disqualification but will receive a 3-point penalty for each simple change performed. Riders are encouraged to advance their skill in 4-H, hence those horses who perform flying lead changes in the class will earn credit over those who perform only simple changes.

AQHA green western riding patterns 1, 2 or 4 should be used.

If a show offers English western riding and allows simple lead changes, the class should be listed on the show bill as green English/western riding. Only standard English/western riding (in which four or more simple lead changes results in disqualification) will be offered at the Michigan State 4-H Horse Show.

RANCH RIDING - PATTERN 1

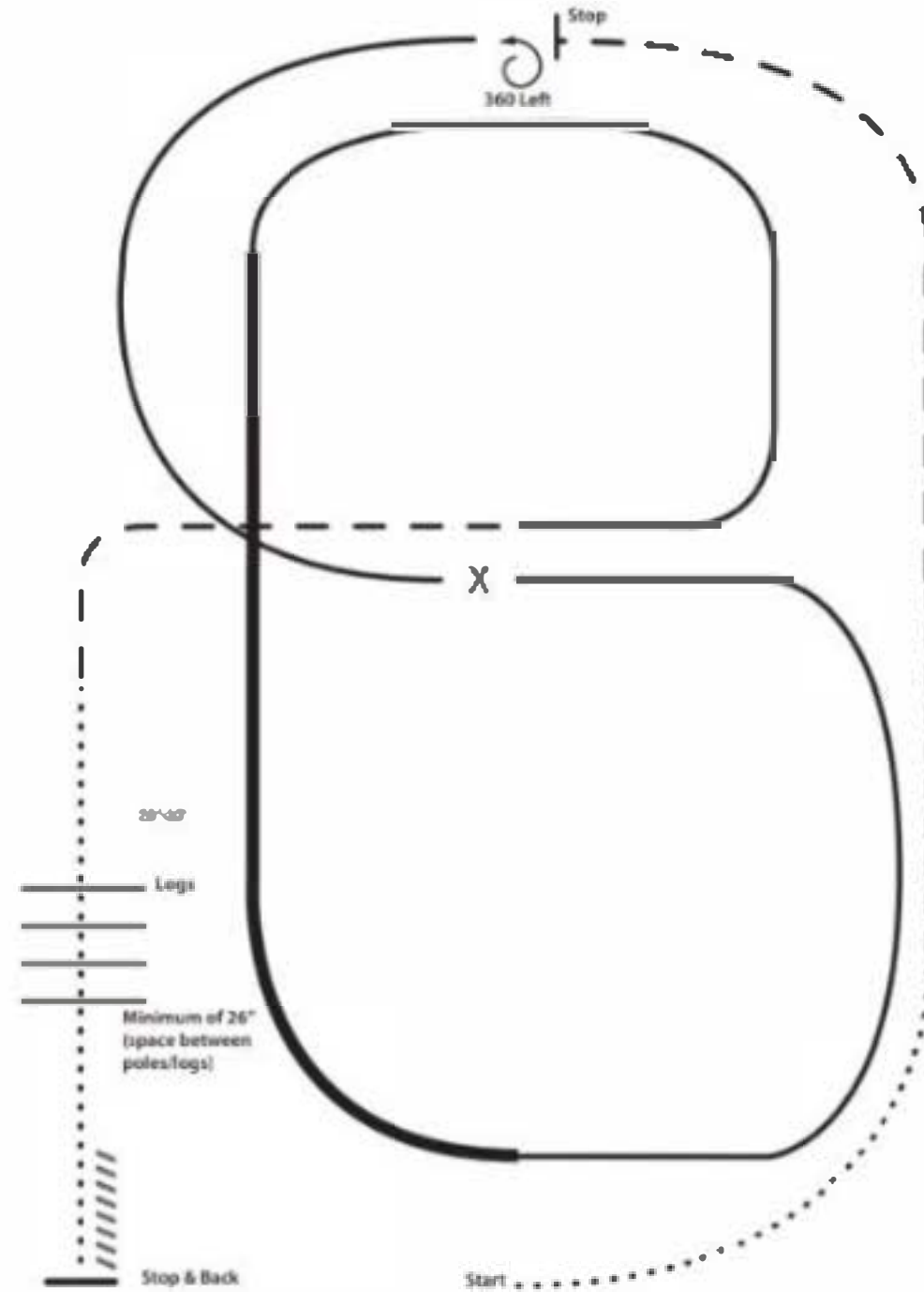

- X Lead Change
- Walk
- - Trot
- — Ext Trot
- — Lope
- — Ext Lope
- //// Back

1. Walk
2. Trot
3. Extend the trot. at the top of the arena stop
4. 360 degree turn to the left
5. Left lead 1/2 circle, lope to the center
6. Change leads (simple or flying)
7. Right lead 1/2 circle
8. Extended lope up the long side of the arena (right lead)
9. Collect back to a lope around the top of the arena and back to center
10. Break down to an extended trot
11. Walk over logs
12. Stop and back

REVISED 2025

2023 USDF INTRODUCTORY LEVEL – TEST A

WALK—TROT

REQUIREMENTS:
 Free walk
 Medium walk
 Working trot rising
 20 meter circle
 Halt through walk

PURPOSE: To introduce the rider and/or horse to the sport of dressage, confirming that they are beginning to develop an understanding of correct dressage basics. The horse should be ridden freely forward in a steady tempo and clear rhythm, accepting contact with the bit. An understanding of test accuracy and geometry should be demonstrated.

NO.

		TEST	DIRECTIVE IDEAS	POINTS	COEF	TOTAL	REMARKS
1.	A	Enter, working trot rising	Regularity, quality of trot; straightness, willing, calm transition.				
	Between X & C	Medium walk	Regularity, quality, of walk				
2.	C	Track right	Bend and balance; willing, calm transition				
	M	Working trot rising					
3.	A	Circle right 20 meters, working trot rising	Regularity; shape and size of circle; bend; balance				
4.	K-X-M	Change rein, working trot rising	Regularity of trot; straightness; bend and balance in corner				
5.	C	Circle left 20 meters, working trot rising	Regularity; shape and size of circle; bend; balance				
6.	Between C & H	Medium walk	Willing, calm transition; regularity, quality				
7.	H-X-F	Free walk	Regularity, reach and ground cover with over track of free walk allowing complete freedom to stretch the neck forward and downward				
8.	F-A	Medium walk	Regularity, quality, willing, calm transition, bend and balance in turn Straightness on centerline.				
	A	Down centerline					
9.	X	Halt and salute	Straightness; attentiveness; immobility (min. 3 seconds)				

Leave arena in free walk, Exit at A.

COLLECTIVE MARKS:

Gaits (freedom and regularity).			
Impulsion (desire to move forward with suppleness of the back and steady tempo).			
Submission (acceptance of steady contact, attention, and confidence).	2		
Rider's position (keeping in balance with horse).			
Rider's effectiveness of aids (correct bend and preparation of transitions).			
Geometry and accuracy (correct size and shape of circles and turns).			

160

FURTHER REMARKS:

SUBTOTAL _____
 ERRORS (-) _____
 TOTAL POINTS _____

To be deducted:
 Errors of the course and omissions
 are penalized 1st Time = 2 points
 2nd Time = 4 points
 3rd Time = Elimination

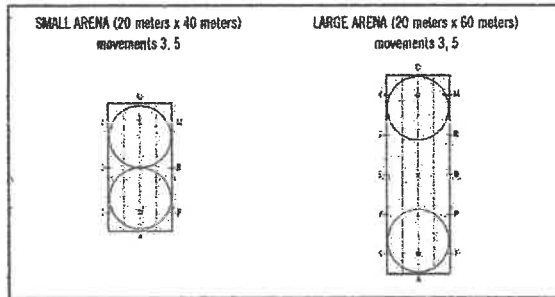

©2022 United State Dressage Federation. All Rights reserved. Reproduction without permission is prohibited by law. USDF is not responsible for any errors or omissions in the publication nor for the use of its copyrighted materials in any unauthorized manner.

UNITED STATES DRESSAGE FEDERATION™

2023

INTRODUCTORY LEVEL – TEST A

WALK–TROT

USDF
INTRODUCTORY
LEVEL TEST

A

This unique series of tests provides an opportunity for the horse and/or rider new to dressage to demonstrate elementary skills. The tests have been designed to encourage correct performance and to prepare the horse for the transition to the USDF tests.

SUGGESTED SCHEDULING TIME
 5:00 Standard Arena
 4:00 Small Arena
 (Possibly longer for schooling shows)

INSTRUCTION:

- All trot work (or be ridden rising).
- Transitions from walk to trot and trot to walk may be performed through sitting trot with the adjective of performing a smooth transition.
- Turns from centerline to long side and long side to centerline should be ridden as a half circle, touching the track at a point midway between the centerline and the corner, and vice versa.

COMMENT:

Horses should be ridden on a light but steady contact, with the exception of the free walk in which the horse is allowed complete freedom to stretch neck forward and downward.



United States Dressage Federation™
 4051 Iron Works Parkway • Lexington, KY 40511
 Phone: (859) 971-2277 • Fax: (859) 971-7722
 usdf@usdf.org • www.usdf.org

Name of Competitor _____
 Class _____
 Date _____
 Name and Horse of Trainer _____
 Name of Rider _____
 Points _____
 Percent _____
 Name of Judge/Preparer _____
 Signature of Judge _____
 Score Sheet effective date: December 1, 2022 - November 30, 2026

MAXIMUM POSSIBLE POINTS: 160

FINAL SCORE

2023 USDF INTRODUCTORY LEVEL – TEST B

REQUIREMENTS:
 Free walk
 Medium walk
 Working trot rising
 20 meter circle
 Halt through walk

PURPOSE: To introduce the rider and/or horse to the sport of dressage, confirming that they are beginning to develop an understanding of correct dressage basics. The horse should be ridden freely forward in a steady tempo and clear rhythm, accepting contact with the bit. An understanding of test accuracy and geometry should be demonstrated.

NO.

		TEST	DIRECTIVE IDEAS	POINTS	COEF	TOTAL	REMARKS
1.	A X	Enter working trot rising. Halt through medium walk Salute - Proceed working trot rising	Regularity, quality of trot; willing, calm transitions; straightness; attentiveness; immobility (min. 3 seconds)				
2.	C	Track left, working trot rising	Regularity; bend and balance in turn and corner				
3.	E	Circle left 20 meters, working trot rising	Regularity; shape and size of circle; bend; balance				
4.	Between K & A	Medium walk	Willing, calm transition; regularity, quality				
5.	F-E	Free walk	Regularity, reach, and ground cover with overtrack of free walk allowing complete freedom to stretch the neck forward and downward				
6.	E-H	Medium walk	Willing, calm transition; regularity, quality, overtrack				
7.	Between H & C	Working trot rising	Willing, calm transition; regularity of trot; bend and balance in corner				
8.	B	Circle right 20 meters, working trot rising	Regularity; shape and size of circle; bend; balance				
9.	A X	Down centerline Halt through medium walk, Salute	Bend and balance in turn; straightness; regularity of trot; willing, calm transition; straightness; attentiveness; immobility (min. 3 seconds)				

Leave arena in free walk. Exit at A.

COLLECTIVE MARKS:

Gaits (freedom and regularity).			
Impulsion (desire to move forward with suppleness of the back and steady tempo).			
Submission (acceptance of steady contact, attention, and confidence).	2		
Rider's position (keeping in balance with horse).			
Rider's effectiveness of aids (correct bend and preparation of transitions).			
Geometry and accuracy (correct size and shape of circles and turns).			

FURTHER REMARKS:

160

SUBTOTAL _____
 ERRORS () _____
 TOTAL POINTS _____

To be deducted
 Errors of the course and omissions
 are penalized 1st Time = 2 points
 2nd Time = 4 points
 3rd Time = Elimination

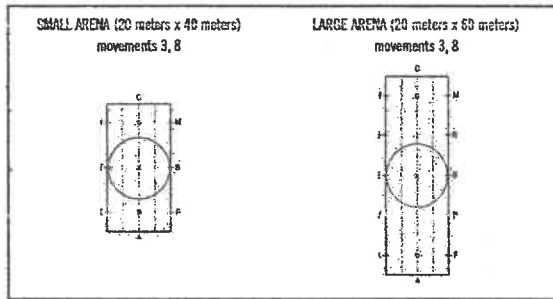

©2022 United State Dressage Federation. All Rights reserved. Reproduction without permission is prohibited by law. USDF is not responsible for any errors or omissions in the publication nor for the use of for copyrighted materials in any unauthorized manner.

UNITED STATES DRESSAGE FEDERATION™
2023
INTRODUCTORY LEVEL - TEST B
 WALK—TROT

B
 USDF
 INTRODUCTORY
 LEVEL TEST

This unique series of tests provides an opportunity for the horse and/or rider new to dressage to demonstrate elementary skills. The tests have been designed to encourage correct performance and to prepare the horse for the transition to the USDF tests.

SUGGESTED SCHEDULING TIME
 5:00 Standard Arena
 4:00 Small Arena
 (Possibly longer for schooling shows)

INSTRUCTION:

- All trot work to be ridden rising.
- Transitions from walk to trot and trot to walk may be performed through sitting trot with the objective of performing a smooth transition.
- Turns from centerline to long side and long side to centerline should be ridden as a half circle, touching the track at a point midway between the centerline and the corner, and vice versa.

COMMENT:
 Horses should be ridden on a light but steady contact, with the exception of the free walk in which the horse is allowed complete freedom to stretch neck forward and downward.

MAXIMUM POSSIBLE POINTS: 160

FINAL SCORE

Points _____

Signature of Judge _____

Signature of Rider _____

Score Sheet effective date: December 1, 2022 - Nov 30, 2026

United States Dressage Federation™
 4051 Iron Works Parkway • Lexington, KY 40511
 Phone (859) 971-2277 • Fax (859) 971-7722
 usdf@usdf.org • www.usdf.org



2023 USDF INTRODUCTORY LEVEL – TEST C

WALK—TROT—CANTER

REQUIREMENTS:
 Free walk
 Medium walk
 Working trot rising
 Working canter
 20 meter circle
 Halt through walk

PURPOSE: To introduce the rider and/or horse to the sport of dressage, confirming that they are beginning to develop an understanding of correct dressage basics. The horse should be ridden freely forward in a steady tempo and clear rhythm, accepting contact with the bit. An understanding of test accuracy and geometry should be demonstrated.

NO.

READER PLEASE NOTE: Anything in parentheses should not be read.

		TEST	DIRECTIVE IDEAS	POINTS	COEF	TOTAL	REMARKS
1.	A X	Enter working trot rising. Halt through medium walk. Salute - Proceed working trot rising	Regularity; quality of trot; willing, calm transitions; straightness; attentiveness; immobility (min. 3 seconds)				
2.	C	Track right, working trot rising	Regularity; bend and balance in turn and corner				
3.	B	Circle right 20 meters, working trot rising	Regularity; shape and size of circle; bend; balance				
4.	A Before A	Circle right 20 meters developing working canter in first quarter of the circle, right lead Working trot rising	Regularity of gaits; shape and size of circle; bend; balance				
5.		(Transition in & out of canter)	Willing and calm transitions				
6.	K-X-M	Change rein, working trot rising	Regularity of trot; straightness; bend and balance in corners				
7.	E	Circle left 20 meters, working trot rising	Regularity; shape and size of circle; bend; balance				
8.	A Before A	Circle left 20 meters developing working canter in first quarter of the circle, left lead Working trot rising	Regularity and quality of gaits; shape and size of circle; bend; balance				
9.		(Transition in & out of canter)	Willing and calm transitions				
10.	Between F & B	Medium walk	Willing, calm transition; regularity, quality, overtrack				
11.	B-H H	Free walk Medium walk	Regularity and quality of walks; reach and ground cover with overtrack; allowing complete freedom to stretch the neck forward and downward; straightness; willing, calm transitions				
12.	Between C & M	Working trot rising to A	Willing, calm transition; regularity of trot; bend and balance in corner; straightness				
13.	A X	Down centerline Halt through medium walk Salute	Bend and balance in turn; regularity of trot; willing, calm transition; straightness; attentiveness; immobility (min. 3 seconds)				

Leave arena in free walk. Exit at A.

©2022 United State Dressage Federation. All Rights reserved. Reproduction without permission is prohibited by law. USDF is not responsible for any errors or omissions in the publication nor for the use of its copyrighted materials in any unauthorized manner.

COLLECTIVE MARKS:

Gaits (freedom and regularity).			
Impulsion (desire to move forward with suppleness of the back and steady tempo).			
Submission (acceptance of steady contact, attention, and confidence).	2		
Rider's position (keeping in balance with horse).			
Rider's effectiveness of aids (correct bend and preparation of transitions).			
Geometry and accuracy (correct size and shape of circles and turns).			

200

FURTHER REMARKS:

SUBTOTAL _____
 ERRORS (-) _____
 TOTAL POINTS _____

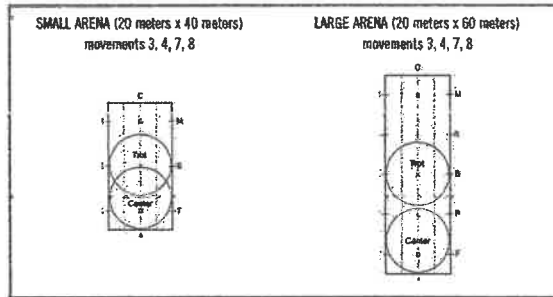

To be deducted
 Errors of the course and omissions
 are penalized 1st Time = 2 points
 2nd Time = 4 points
 3rd Time = Elimination

©2022 United State Dressage Federation. All rights reserved. Reproduction without permission is prohibited by law. USDF is not responsible for any errors or omissions in the publication nor for the use of its copyrighted materials in any unauthorized manner.

UNITED STATES DRESSAGE FEDERATION™

2023

INTRODUCTORY LEVEL – TEST C

WALK—TROT—CANTER!

USDF
 INTRODUCTORY
 LEVEL TEST
C

This unique series of tests provides an opportunity for the horse and/or rider new to dressage to demonstrate elementary skills. The tests have been designed to encourage correct performance and to prepare the horse for the transition to the USEF tests.

SUGGESTED SCHEDULING TIME
 6:00 Standard Arena
 5:00 Small Arena
 (Possibly longer for schooling shows)

INSTRUCTION:

- All trot work to be ridden rising.
- Transitions from trot to canter and canter to trot may be performed through sitting trot with the objective of performing a smooth transition.
- Turns from centerline to long side and long side to centerline should be ridden as a half circle, touching the track at a point midway between the centerline and the corner, and vice versa.

COMMENT:

Horses should be ridden on a light but steady contact, with the exception of the free walk in which the horse is allowed complete freedom to stretch neck forward and downward.

United States Dressage Federation™
 4051 Jean Vester Parkway • Lexington, KY 40511
 Phone: (859) 971-2277 • Fax: (859) 971-7722
 usdf@usdf.org • www.usdf.org



Name of Competition _____

Class _____

Date _____

Name and Status of Horse _____

Name of Rider _____

Points _____ Percent _____

Signature of Judge _____

Score Sheet effective date: December 1, 2022 - November 30, 2026

MAXIMUM POSSIBLE POINTS: 200
FINAL SCORE



2023 USEF TRAINING LEVEL TEST 1



PURPOSE

To confirm that the horse demonstrates correct basics, by showing suppleness both laterally and longitudinally, moving freely forward in a clear rhythm with a steady tempo, and readily accepting contact with the bit. Correct geometry and lines of travel should be shown.

All trot work may be ridden sitting or rising, unless otherwise stated.
Halts may be through the walk.

READER PLEASE NOTE: Anything in parentheses should not be read.

INTRODUCE	ENTRY NO.: _____
Working trot; working canter; medium walk; free walk; 20m circles in trot and canter	Conditions: ARENA SIZE: Standard or Small AVERAGE RIDE TIME: 5:00 (Std.) or 4:00 (Small) (from entry at A to final halt) Suggested to add at least 2 min. for scheduling purposes
	MAXIMUM PTS: 260

TEST		DIRECTIVES	POINTS	COEF	TOTAL	REMARKS
1.	A X	Enter working trot Halt, salute Proceed working trot	Regularity and quality of trot; willing, calm transitions; straightness; attentiveness; immobility (min. 3 seconds)			
2.	C E	Track left Circle left 20m	Regularity and quality of trot; shape and size of circle; bend; balance	2		
3.	A	Circle left 20m developing left lead canter in first quarter of circle	Willing, calm transition; regularity and quality of gaits; shape and size of circle; bend; balance			
4.	A-F-B	Working canter	Regularity and quality of canter; bend and balance in corner; straightness			
5.	Between B & M	Working trot	Willing, calm transition; regularity and quality of gaits; straightness; bend and balance in corner	2		
6.	Between C & H	Medium walk	Willing, calm transition; regularity, quality, bend and balance in corner	2		
7.	E-F F	Change rein, free walk Medium walk	Regularity and quality of walks; reach, overtrack, and ground cover of free walk allowing complete freedom to stretch the neck forward and downward; straightness; willing, calm transitions	2		
8.	A	Working trot	Willing, calm transition; regularity and quality of trot; bend and balance in corner; straightness			
9.	E	Circle right 20m	Regularity and quality of trot; shape and size of circle; bend; balance	2		
10.	C	Circle right 20m developing right lead canter in first quarter of circle	Willing, calm transition; regularity and quality of gaits; shape and size of circle; bend; balance			
11.	C-M-B	Working canter	Regularity and quality of canter; bend and balance in corner; straightness			
12.	Between B & F	Working trot	Willing, calm transition; regularity and quality of gaits; straightness; bend and balance in corner	2		
13.	A X	Down centerline Halt, salute	Bend and balance in turn; regularity and quality of trot; willing, calm transition; straightness; attentiveness; immobility (min. 3 seconds)			

Leave arena at A in free walk.



2023 USEF TRAINING LEVEL TEST 1



COLLECTIVE MARKS			
GAITS (Freedom and regularity)		1	
IMPULSION (Desire to move forward; elasticity of the steps; suppleness of the back; engagement of the hindquarters)		2	
SUBMISSION (Willing cooperation; harmony; attention and confidence; acceptance of bit and aids; straightness; lightness of forehand and ease of movements)		2	
RIDER'S POSITION AND SEAT (Alignment; posture; stability; weight placement; following mechanics of the gaits)		1	
RIDER'S CORRECT AND EFFECTIVE USE OF AIDS (Clarity; subtlety; independence; accuracy of test)		1	
FURTHER REMARKS:			
		SUBTOTAL:	
To be deducted Errors of the course and omissions are penalized		ERRORS: ()	
		TOTAL POINTS: (Max Points: 260)	
		1st Time = 2 points 2nd Time = 4 points 3rd Time = Elimination	

United States Equestrian Federation, Inc. 2023 USEF TRAINING LEVEL TEST 1	
_____	Name of Competition
_____	Date of Competition
_____	Name and Number of Horse
_____	Name of Rider
Final Score Maximum Pts: 260	
_____	Points
_____	Percent
_____	Name of Judge
_____	Signature of Judge

Score Sheet effective date: December 1, 2022 - November 30, 2026



2023 USEF TRAINING LEVEL TEST 2

PURPOSE

To confirm that the horse demonstrates correct basics, by showing suppleness both laterally and longitudinally, moving freely forward in a clear rhythm with a steady tempo, and readily accepting contact with the bit. Correct geometry and lines of travel should be shown.

All trot work may be ridden sitting or rising, unless otherwise stated.
Halts may be through the walk.

READER PLEASE NOTE: Anything in parentheses should not be read.

INTRODUCE	ENTRY NO. <input style="width: 100px;" type="text"/>
Stretch circle in trot	Conditions: ARENA SIZE: Standard or Small AVERAGE RIDE TIME: 4:30 (Std.) or 4:30 (Small) (from entry at A to final halt) <i>Suggested to add at least 2 min. for scheduling purposes</i>
	MAXIMUM PTS. 290 <input style="width: 50px;" type="text"/>

TEST		DIRECTIVES	POINTS	COEF	TOTAL	REMARKS
1.	A X	Enter working trot Halt, salute Proceed working trot	Regularity and quality of trot; willing, calm transitions; straightness; attentiveness; immobility (min. 3 seconds)			
2.	C B	Track right Circle right 20m	Regularity and quality of trot; shape and size of circle; bend and balance			
3.	K-X-M	Change rein	Regularity and quality of trot; straightness; bend and balance in corner	2		
4.	Between G & H	Working canter left lead	Willing, calm transition; regularity and quality of gaits; bend and balance in corner; straightness	2		
5.	E	Circle left 20m	Regularity and quality of canter; shape and size of circle; bend; balance			
6.	Between E & K	Working trot	Willing, calm transition; regularity and quality of gaits; straightness; bend and balance in corner			
7.	A Before A A	Circle left 20m rising trot, allowing the horse to stretch forward and downward while maintaining contact Shorten the reins Working trot	Forward and downward stretch over the back into a light contact, maintaining balance and quality of trot; bend; shape and size of circle; willing, calm transitions			
8.	F F-E	Medium walk Change rein, medium walk	Willing, calm transition; regularity, overtrack, and quality of walk	2		
9.	E-M M	Change rein, free walk Medium walk	Regularity and quality of walks; reach, overtrack, and ground cover of free walk allowing complete freedom to stretch the neck forward and downward; straightness; willing, calm transitions	2		
10.	C	Working trot	Willing, calm transition; regularity and quality of trot; bend and balance in corner; straightness			
11.	E	Circle left 20m	Regularity and quality of trot; shape and size of circle; bend; balance			
12.	F-X-H	Change rein	Regularity and quality of trot; straightness; bend and balance in corner	2		
13.	Between C & M	Working canter right lead	Willing, calm transition; regularity and quality of gaits; bend and balance in corner; straightness	2		
14.	B	Circle right 20m	Regularity and quality of canter; shape and size of circle; bend; balance			
15.	Between B & F	Working trot	Willing, calm transition; regularity and quality of gaits; straightness; bend and balance in corner			
16.	A X	Down centerline Halt, salute	Bend and balance in turn; regularity and quality of trot; willing, calm transition; straightness; attentiveness; immobility (min. 3 seconds)			

Leave arena at A in free walk.

©2023 United States Dressage Federation (USDF) and United States Equestrian Federation (USEF). All rights reserved. Reproduction without permission is prohibited by law. Neither USDF nor USEF is responsible for any errors or omissions in the publication or for the use of its copyrighted material in an unauthorized manner.



2023 USEF TRAINING LEVEL TEST 2



COLLECTIVE MARKS			
GAITS (Freedom and regularity)		1	
IMPULSION (Desire to move forward; elasticity of the steps; suppleness of the back; engagement of the hindquarters)		2	
SUBMISSION (Willing cooperation; harmony; attention and confidence; acceptance of bit and aids; straightness; lightness of forehand and ease of movements)		2	
RIDER'S POSITION AND SEAT (Alignment; posture; stability; weight placement; following mechanics of the gaits)		1	
RIDER'S CORRECT AND EFFECTIVE USE OF AIDS (Clarity; subtlety; independence; accuracy of test)		1	
FURTHER REMARKS:			
		SUBTOTAL:	
To be deducted Errors of the course and omissions are penalized		ERRORS: { }	
1st Time = 2 points 2nd Time = 4 points 3rd Time = Elimination		TOTAL POINTS: (Max Points: 290)	

United States Equestrian Federation, Inc. 2023 USEF TRAINING LEVEL TEST 2	
Name of Competition	
Date of Competition	
Name and Number of Horse	
Name of Rider	
Final Score Maximum Pts: 290	
Points	Percent
Name of Judge	
Signature of Judge	

Score Sheet effective date: December 1, 2022 - November 30, 2026



2023 USEF TRAINING LEVEL TEST 3

PURPOSE

To confirm that the horse demonstrates correct basics, by showing suppleness both laterally and longitudinally, moving freely forward in a clear rhythm with a steady tempo, and readily accepting contact with the bit. Correct geometry and lines of travel should be shown.

All trot work may be ridden sitting or rising, unless otherwise stated.
Halts may be through the walk.

READER PLEASE NOTE: Anything in parentheses should not be read.

INTRODUCE	ENTRY NO: _____
Changing of bend on a shallow loop, canter-trot transition on diagonal	Conditions: ARENA SIZE: Standard or Small AVERAGE RIDE TIME: 5:30 (Std.) or 4:30 (Small) (from entry at A to final halt) Suggested to add at least 2 min. for scheduling purposes
	MAXIMUM PTS: 250

TEST		DIRECTIVES	POINTS	COEF	TOTAL	REMARKS
1.	A X	Enter working trot Halt, salute Proceed working trot	Regularity and quality of trot; willing, calm transitions; straightness; attentiveness; immobility (min. 3 seconds)			
2.	C H-X-K	Track left Slightly after H begin a single loop to X returning to the track slightly before K	Regularity and quality of trot; bend and balance in turns; shape and size of loop; changes of bend; balance	2		
3.	Between A & F	Working canter left lead	Willing, calm transition; regularity and quality of gaits; bend in corner; straightness			
4.	B	Circle left 20m	Regularity and quality of canter; shape and size of circle; bend; balance			
5.	H-X-F X	Change rein Working trot	Regularity and quality of gaits; willing, calm transition; straightness; bend in corner			
6.	A	Medium walk	Willing, calm transition; regularity, quality	2		
7.	K-X-H H	Free walk Medium walk	Regularity and quality of walks; reach, overtrack, and ground cover of free walk allowing complete freedom to stretch the neck forward and downward; straightness; willing, calm transitions	2		
8.	C M-X-F	Working Trot Slightly after M begin a single loop to X returning to the track slightly before F	Regularity and quality of trot; shape and size of loop; changes of bend and balance	2		
9.	Between A & K	Working canter right lead	Willing, calm transition; regularity and quality of gaits; bend and balance in corner; straightness			
10.	E	Circle right 20m	Regularity and quality of canter; shape and size of circle; bend; balance			
11.	C	Working trot	Willing, calm transition; regularity and quality of trot			
12.	B Before B B	Circle right 20m in rising trot allowing the horse to stretch forward and downward Shorten the reins Working trot	Forward and downward stretch over the back into a light contact, maintaining balance and quality of trot; bend; shape and size of circle; willing, calm transitions	2		
13.	A X	Down centerline Halt, salute	Bend and balance in turn; regularity and quality of trot; willing, calm transition; straight, attentive halt; immobile (min. 3 seconds)			

Leave arena at A in free walk.



2023 USEF TRAINING LEVEL TEST 3



COLLECTIVE MARKS			
GAITS (Freedom and regularity)		1	
IMPULSION (Desire to move forward; elasticity of the steps; suppleness of the back; engagement of the hindquarters)		2	
SUBMISSION (Willing cooperation; harmony; attention and confidence; acceptance of bit and aids; straightness; lightness of forehand and ease of movements)		2	
RIDER'S POSITION AND SEAT (Alignment; posture; stability; weight placement; following mechanics of the gaits)		1	
RIDER'S CORRECT AND EFFECTIVE USE OF AIDS (Clarity; subtlety; independence; accuracy of test)		1	
FURTHER REMARKS:			
<p>To be deducted Errors of the course and omissions are penalized</p> <p>1st Time = 2 points 2nd Time = 4 points 3rd Time = Elimination</p>		 <p>Movements #2 and #8</p>	
		<p>SUBTOTAL:</p> <p>ERRORS: (-)</p> <p>TOTAL POINTS: (Max Points: 250)</p>	

United States Equestrian Federation, Inc. 2023 USEF TRAINING LEVEL TEST 3	
_____	Name of Competition
_____	Date of Competition
_____	Name and Number of Horse
_____	Name of Rider
Final Score Maximum Pts: 250	
_____	Points
_____	Percent
_____	Name of Judge
_____	Signature of Judge

Score Sheet effective date: December 1, 2022 - November 30, 2025



2023 USEF FIRST LEVEL TEST 1

PURPOSE

To confirm that the horse demonstrates correct basics, and in addition to the requirements of Training Level, has developed improved balance, lateral suppleness and throughness, as well as the thrust to perform lengthenings of stride. The horse should be on the bit.

All trot work may be ridden sitting or rising, unless otherwise stated.

READER PLEASE NOTE: Anything in parentheses should not be read.

INTRODUCE	ENTRY NO: _____
10m half circle at trot; 15m circle in canter; lengthening of stride in trot	<u>Conditions:</u> ARENA SIZE: Standard AVERAGE RIDE TIME: 5:30 (from entry at A to final halt) Suggested to add at least 2 min. for scheduling purposes
	MAXIMUM PTS: 270

	TEST	DIRECTIVES	POINTS	COEF	TOTAL	REMARKS
1.	A X	Enter working trot Halt, salute Proceed working trot	Regularity and quality of trot; willing, clear transitions; straightness; attentiveness; immobility (min. 3 seconds).			
2.	C E-X	Track left Half circle left 10m, returning to track at H	Regularity and quality of trot; shape and size of half circle; bend; balance; straightness			
3.	B-X	Half circle right 10m, returning to track at M	Regularity and quality of trot; shape and size of half circle; bend; balance; straightness			
4.	C Before C C	Circle left 20m in rising trot, allowing the horse to stretch forward and downward while maintaining contact Shorten the reins Working trot	Forward and downward stretch over the back into a light contact, maintaining balance and quality of trot; bend; shape and size of circle; willing, clear transitions	2		
5.	H-P P	Change rein, lengthen stride in trot Working trot	Moderate lengthening of frame and stride; regularity and quality of trot; straightness; consistent tempo; willing, clear transitions; bend and balance in corner.			
6.	A	Medium walk	Willing, clear transition; regularity, quality, overtrack; bend and balance in corner; straightness	2		
7.	V-R R	Change rein, free walk Medium walk	Regularity and quality of walks; reach and ground cover with overtrack of free walk allowing complete freedom to stretch the neck forward and downward; straightness; willing, clear transitions.	2		
8.	M C	Working trot Working canter left lead	Willing, clear transitions; regularity and quality of gaits; bend and balance in corners	2		
9.	E	Circle left 15m	Regularity and quality of canter; shape and size of circle; bend; balance			
10.	F-X-H X	Change rein Working trot	Willing, clear transition; regularity and quality of gaits; straightness; bend and balance in corner			
11.	C	Working canter right lead	Willing, clear transition; regularity and quality of canter; bend and balance in corner	2		
12.	B	Circle right 15m	Regularity and quality of canter; shape and size of circle; bend; balance			
13.	A	Working trot	Willing, clear transition; regularity and quality of trot; straightness; bend and balance in corner			
14.	K-R R	Change rein, lengthen stride in trot Working trot	Moderate lengthening of frame and stride; regularity and quality of trot; straightness; consistent tempo; willing, clear transitions; bend and balance in corners			
15.	E X G	Half circle left 10m Down centerline Halt, salute	Bend and balance in half circle; regularity and quality of trot; willing, clear transition; straightness; attentiveness; immobility (min. 3 seconds)			

Leaves arena at A in free walk.



2023 USEF FIRST LEVEL TEST 1



COLLECTIVE MARKS			
GAITS (Freedom and regularity)		1	
IMPULSION (Desire to move forward; elasticity of the steps; suppleness of the back; engagement of the hindquarters)		2	
SUBMISSION (Willing cooperation; harmony; attention and confidence; acceptance of bit and aids; straightness; lightness of forehand and ease of movements)		2	
RIDER'S POSITION AND SEAT (Alignment; posture; stability; weight placement; following mechanics of the gaits)		1	
RIDER'S CORRECT AND EFFECTIVE USE OF AIDS (Clarity; subtlety; independence; accuracy of test)		1	
FURTHER REMARKS:			
To be deducted Errors of the course and omissions are penalized		1st Time = 2 points 2nd Time = 4 points 3rd Time = Elimination	SUBTOTAL: ERRORS: () TOTAL POINTS: (Max Points: 270)

United States Equestrian Federation, Inc. 2023 USEF FIRST LEVEL TEST 1	
_____	Name of Competition
_____	Date of Competition
_____	Name and Number of Horse
_____	Name of Rider
Final Score Maximum Pts: 270	
_____	Points
_____	Percent
_____	Name of Judge
_____	Signature of Judge

Score Sheet effective date: December 1, 2022 - November 30, 2026



2023 USEF FIRST LEVEL TEST 2

PURPOSE

To confirm that the horse demonstrates correct basics, and in addition to the requirements of Training Level, has developed improved balance, lateral suppleness and throughness, as well as the thrust to perform lengthenings of strides. The horse should be on the bit.

All trot work may be ridden sitting or rising, unless otherwise stated.

READER PLEASE NOTE: Anything in parentheses should not be read.

INTRODUCE	ENTRY NO: <input type="text"/>
Leg yield; Lengthen stride in canter	<u>Conditions:</u> ARENA SIZE: Standard AVERAGE RIDE TIME: 9:30 (5min entry at A to final bar) Suggested to add at least 2 min. for scheduling purposes
	MAXIMUM PFS: 330 <input type="text"/>

	TEST	DIRECTIVES	POINTS	COEF	TOTAL	REMARKS
1.	A X	Enter working trot Halt, salute Proceed working trot	Regularity and quality of trot; willing, clear transitions; straightness; attentiveness; immobility (min. 3 seconds)			
2.	G M-V V	Track right Change rein, lengthen stride in trot Working trot	Bend and balance in turns; moderate lengthening of frame and stride; regularity and quality of trot; willing, clear transitions; straightness; consistent tempo			
3.	A L-M	Turn down centerline Leg yield right	Regularity and quality of trot; straightness on centerline; consistent tempo; alignment; balance and flow	2		
4.	H-P P	Change rein, lengthen stride in trot Working trot	Moderate lengthening of frame and stride; regularity and quality of trot; willing, clear transitions; straightness; consistent tempo			
5.	A L-H	Turn down centerline Leg yield left	Regularity and quality of trot; straightness on centerline; consistent tempo; alignment; balance and flow	2		
6.	C	Medium walk	Willing, clear transition; regularity, quality, overtrack; bend and balance in corner	2		
7.	M-V V	Change rein, free walk Medium walk	Regularity and quality of walks; reach and ground cover with overtrack of free walk allowing complete freedom to stretch the neck forward and downward; straightness; willing, clear transitions	2		
8.	K A	Working trot Working canter left lead	Willing, clear transitions; regularity and quality of gaits; bend and balance in corners			
9.	P	Circle left 15m	Regularity and quality of canter; shape and size of circle; bend; balance			
10.	P-M	Lengthen stride in canter	Willing, clear transition; moderate lengthening of frame and stride; regularity and quality of canter; straightness; consistent tempo	2		
11.	Between M-C	Develop working canter	Willing, clear transition; regularity and quality of canter; bend and balance in corners			
12.	H-X-F X	Change rein Working trot	Willing, clear transition; regularity and quality of gaits; straightness			
13.	F	Working canter right lead	Willing, clear transition; regularity and quality of canter; bend and balance in corners			
14.	V	Circle right 15m	Regularity and quality of canter; shape and size of circle; bend; balance			
15.	V-H	Lengthen stride in canter	Willing, clear transition; moderate lengthening of frame and stride; regularity and quality of canter; straightness; consistent tempo	2		
16.	Between H-C	Develop working canter	Willing, clear transition; regularity and quality of canter; bend and balance in corners			
17.	M	Working trot	Willing, clear transition; regularity and quality of trot; straightness			
18.	B Before B B	Circle right 20m rising trot, allowing the horse to stretch forward and downward while maintaining contact Shorten the reins Working trot	Forward and downward stretch over the back into a light contact, maintaining balance and quality of trot; bend; shape and size of circle; willing, clear transitions	2		
19.	A X	Down centerline Halt, salute	Bend and balance in turn; regularity and quality of trot; willing, clear transition; straightness; attentiveness; immobility (min. 3 seconds)			
Leave arena at A in free walk.						



2023 USEF FIRST LEVEL TEST 2



COLLECTIVE MARKS			
GAITS (Freedom and regularity)		1	
IMPULSION (Desire to move forward; elasticity of the steps; suppleness of the back; engagement of the hindquarters)		2	
SUBMISSION (Willing cooperation; harmony; attention and confidence; acceptance of bit and aids; straightness; lightness of forehand and ease of movements)		2	
RIDER'S POSITION AND SEAT (Alignment; posture; stability; weight placement; following mechanics of the gaits)		1	
RIDER'S CORRECT AND EFFECTIVE USE OF AIDS (Clarity; subtlety; independence; accuracy of test)		1	
FURTHER REMARKS:			
		SUBTOTAL:	
To be deducted Errors of the course and omissions are penalized		ERRORS: (-)	
		TOTAL POINTS: (Max Points: 330)	

United States Equestrian Federation, Inc. 2023 USEF FIRST LEVEL TEST 2	
_____	Name of Competition
_____	Date of Competition
_____	Name and Number of Horse
_____	Name of Rider
Final Score Maximum Pts: 330	
_____	Points
_____	Percent
_____	Name of Judge
_____	Signature of Judge

Score Sheet effective date: December 1, 2022 - November 30, 2028

**Thank you to the staff at the MSU
Extension office and special thanks to
the leaders who have put in many
hours to put this together.**

**Please BRING THIS PACKET WITH
YOU to the POINT SHOWS and
FAIR as you will need the show
bills and other forms etc.**

