

**Fair Use**  
of this PDF file of

Highbush Blueberry Production Guide, NRAES-55  
Marvin P. Pritts and James F. Hancock, editors  
Published by NRAES, October 1992

This PDF file is for viewing only. If a paper copy is needed, we encourage you to purchase a copy as described below.

**Be aware that practices, recommendations, and economic data may have changed since this book was published.**

Text can be copied. The book, authors, and NRAES should be acknowledged. Here is a sample acknowledgement:

---- From Highbush Blueberry Production Guide, NRAES-55, Marvin P. Pritts and James F. Hancock, editors, and published by NRAES (1992).----

No use of the PDF should diminish the marketability of the printed version. This PDF should not be used to make copies of the book for sale or distribution.

If you have questions about fair use of this PDF, contact NRAES.

**Purchasing the Book**

You can purchase printed copies on NRAES' secure web site, [www.nraes.org](http://www.nraes.org), or by calling (607) 255-7654. Quantity discounts are available.

NRAES  
PO Box 4557  
Ithaca, NY 14852-4557  
Phone: (607) 255-7654  
Fax: (607) 254-8770  
Email: [nraes@cornell.edu](mailto:nraes@cornell.edu)  
Web: [www.nraes.org](http://www.nraes.org)

More information on NRAES is included at the end of this PDF.

# ***Highbush Blueberry Production Guide***

This guide is the second in a series of small-fruit publications originating with NEC-64, a committee sponsored by the state experiment stations for the study of berry crop production and marketing. The *Bramble Production Guide* (NRAES-35) is the first publication.

## ***Editors***

Marvin P. Pritts, Associate Professor, Cornell University  
James F. Hancock, Professor, Michigan State University

## ***Contributing Editor***

Bernadine Strik, Assistant Professor, Oregon State University

## ***Illustrator***

Marcia Eames-Sheavly

## ***Production Editor and Designer***

Dana Celentano

***Northeast Regional Agricultural Engineering Service  
152 Riley-Robb Hall  
Cooperative Extension  
Ithaca, New York 14853***

---

# ACKNOWLEDGMENTS

---

Special thanks to the following reviewers who made important contributions to this production guide:

Wesley Autio, pomologist, University of Massachusetts; Michael Burgett, entomologist, Oregon State University; Robert Childs, grower, New York; John Clark, pomologist, University of Arkansas; Rodney Cook, Michigan Blueberry Growers' Association; Arlen Draper, plant breeder, USDA (retired); Chad Finn, assistant professor of horticulture/state fruit crop specialist, University of Missouri; Glenn Fisher, entomologist, Oregon State University; Gene Galletta, plant breeder, USDA, Maryland; Barbara Goulart, pomologist, The Pennsylvania State University; David Himelrick, pomologist, Auburn University; James Johnson, entomologist, Michigan State University; Ron Korcak, plant physiologist, USDA, Maryland; Kenna MacKenzie, entomologist, Cornell University; Charles Mainland, extension specialist, North Carolina State University; Phil Marucci, Tru Blue Cooperative, New Jersey; Roger Morse, entomologist, Cornell University; Gail Nonnecke, pomologist, Iowa State University; Dean Polk, entomologist, Rutgers University; Jay Pscheidt, pathologist, Oregon State University; Ed Rajotte, entomologist, The Pennsylvania State University; Marty Sailus, director, Northeast Regional Agricultural Engineering Service; Ken Samoil, entomologist, Rutgers University; Craig Storlie, agricultural engineer, Rutgers University; Allan Stretch, pathologist, Rutgers University; David Trinko, Michigan Blueberry Growers' Association; Nicholi Vorsa, plant breeder, Rutgers University; Ray William, weed and vegetation management specialist, Oregon State University.

The following provided photographs for this guide:

Art Agnello, Paul Curtis, Marvin Pritts, and Wayne Wilcox (Cornell University); Dan Barney (University of Idaho); Paul Eck, Gary Pavlis, Allan Stretch, and Nicholi Vorsa (Rutgers University); Erwin Elsner, James Hancock, Eric Hanson, and Don Ramsdell (Michigan State University); David Himelrick (Auburn University); John Meyer (North Carolina State University); Fred Olday (Jasper Wyman and Sons, Maine); Bernadine Strik (Oregon State University).

**NRAES-55**

October 1992

©1992 by the Northeast Regional Agricultural Engineering Service  
All rights reserved. Inquiry invited. (607) 255-7654.

# TABLE OF CONTENTS

---

ABOUT THE AUTHORS .....	iii
LIST OF TABLES .....	v
LIST OF FIGURES .....	vii
KEY TO PHOTOGRAPHS.....	viii
INTRODUCTION .....	1
CHAPTER 1: THE Highbush Blueberry .....	4
Taxonomy•History•For More Information	
CHAPTER 2: Blueberry Growth and Development .....	9
Plant Growth Habit•Root System•Flowering•Fruit•Environmental Stress	
CHAPTER 3: Site Selection and Preparation .....	17
Climate•Soil•Soil Drainage•Irrigation•Air Drainage•Location to Markets• Site Preparation•Fumigation•Cover Crops•For More Information	
CHAPTER 4: Plant Selection and Propagation .....	22
Blueberry Varieties•Blueberry Propagation	
CHAPTER 5: Establishing the Blueberry Planting .....	34
Field Layout•Planting•Managing the New Planting	
CHAPTER 6: Maintenance of the Established Planting .....	37
Pruning•Mulching•Pollination•For More Information	
CHAPTER 7: Nuisance Wildlife Management .....	41
Birds•Deer•Voles•Pocket Gophers•Woodchucks•For More Information	
CHAPTER 8: Arthropod Management .....	55
Pests Infesting Buds•Pests Infesting Flowers and Fruit•Pests Infesting Leaves and Shoots•Pests Infesting Stems, Canes, Crowns, and Roots•For More Information	
CHAPTER 9: Nematode and Disease Management .....	76
Nematodes•Virus and Virus-Like Diseases•Fungal Diseases•For More Information	
CHAPTER 10: Weed Management .....	95
Preplant Weed Control•Weed Control in New Plantings•Weed Control in Established Plantings•For More Information	
CHAPTER 11: Nutrient Management .....	99
Symptoms of Nutritional Problems•Soil Testing•Leaf Analysis•Fertilizers and Rates	
CHAPTER 12: Water Management .....	110
Excess-Water Considerations•Deciding to Irrigate•Water Supply Considerations• Selecting an Irrigation System•Scheduling Irrigation•Equipment Use and Maintenance•For More Information	

[continued on next page]



CHAPTER 13: SPRAY APPLICATION TECHNOLOGY ..... 128  
 Power Spraying Equipment•Spraying Equipment for Small Plantings•Sprayer  
 Maintenance

CHAPTER 14: HARVESTING AND HANDLING BLUEBERRIES ..... 142  
 Preharvest Treatment•Harvest•Transportation•For More Information

CHAPTER 15: MARKETING BLUEBERRIES ..... 149  
 Production and Price Trends•Marketing Options•USDA Standards for Blueberry  
 Grades

CHAPTER 16: BLUEBERRY CROP BUDGETING ..... 156  
 Types of Costs•Blueberry Enterprise Budget•Developing Your Own Budget•  
 Case Study

APPENDIX 1: CALCULATING CATION EXCHANGE CAPACITY OF A SOIL ..... 169

APPENDIX 2: FERTIGATION FOR BLUEBERRIES ..... 172  
 Adjusting pH of the Irrigation Water•Applying Fertilizers through Irrigation

KEY TO BLUEBERRY PROBLEMS ..... 174

TABLE OF CONVERSION FACTORS ..... 179

PHOTOGRAPHS ..... 180

GLOSSARY ..... 195

SUPPLEMENTAL INFORMATION ..... 199

The Northeast Regional Agricultural Engineering Service (NRAES) is an official activity of thirteen land grant universities and the U.S. Department of Agriculture. The following are cooperating members:

University of Connecticut  
 Storrs, CT

Rutgers University  
 New Brunswick, NJ

University of Delaware  
 Newark, DE

Cornell University  
 Ithaca, NY

University of the District of Columbia  
 Washington, DC

The Pennsylvania State University  
 University Park, PA

University of Maine  
 Orono, ME

University of Rhode Island  
 Kingston, RI

University of Maryland  
 College Park, MD

University of Vermont  
 Burlington, VT

University of Massachusetts  
 Amherst, MA

West Virginia University  
 Morgantown, WV

University of New Hampshire  
 Durham, NH

# ABOUT THE AUTHORS

---

ART ANTONELLI is an extension entomologist with Washington State University, Puyallup, WA. [Chapter 8]

DAN BARNEY is an assistant professor and stress physiologist working on fruit crops with the University of Idaho, Sandpoint, ID. [Chapter 2]

PETER BRISTOW is a research pathologist with Washington State University, Puyallup, WA. [Chapter 9]

CHARLES BRUN is a cooperative extension agent with Washington State University, Vancouver, WA. [Chapter 14]

RALPH BYTHER is an extension plant pathologist with Washington State University, Puyallup, WA. [Chapter 9]

MARK CASTALDI is an economist with Dole Dried Fruit and Nut Company, Fresno, CA. [Chapter 16]

PAUL CURTIS is an extension associate with the wildlife damage program in the Department of Natural Resources, Cornell University, Ithaca, NY. [Chapter 7]

DONALD DAUM is a professor with the Department of Agricultural and Biological Engineering, The Pennsylvania State University, University Park, PA. [Chapter 13]

MARCIA EAMES-SHEAVLY is an extension support specialist with the Department of Fruit and Vegetable Science, Cornell University, Ithaca, NY. [Illustrations]

ERWIN ELSNER is an extension agricultural agent in Grand Traverse County, MI. [Chapter 8]

MICHAEL FARGIONE is a research support specialist in the Department of Natural Resources, Cornell University, Hudson Valley Lab, Highland, NY. [Chapter 7]

LARRY GEOHRING is a senior extension associate with the Department of Agricultural and Biological Engineering, Cornell University, Ithaca, NY. [Chapter 12]

JAMES HANCOCK is a professor specializing in blueberries at Michigan State University, East Lansing, MI. [Chapter 4; Key to Blueberry Problems]

ERIC HANSON is an associate professor and extension specialist with the Department of Horticulture at Michigan State University, East Lansing, MI. [Chapters 10, 11, 15]

JOHN HART is an associate professor and extension soils specialist with Oregon State University, Corvallis, OR. [Chapter 11]

DYVON HAVENS is a cooperative extension agent with Washington State University, Mt. Vernon, WA. [Chapter 10]

RUSSELL INGHAM is an associate professor and nematologist with the Department of Botany and Plant Pathology, Oregon State University, Corvallis, OR. [Chapter 9]

DIANE KAUFMAN is a cooperative extension agent for Oregon State University, Aurora, OR. [Chapter 14]

WILLIAM LORD is an extension fruit specialist with the Department of Plant Biology, University of New Hampshire, Durham, NH. [Chapters 2 and 5]

GARY C. PAVLIS, Ph.D., is an agricultural agent with Rutgers Cooperative Extension of Atlantic County specializing in highbush blueberry production in Mays Landing, NJ. [Chapter 14]

ROSS PENHALLEGON is an extension agent for Oregon State University, Eugene, OR. [Chapter 4]

MARVIN PRITTS is an associate professor and extension fruit specialist with the Department of Fruit and Vegetable Science at Cornell University, Ithaca, NY. [Chapters 1, 3, 6, 16; Appendixes]

DONALD RAMSDELL is a professor specializing in blueberry viruses with the Department of Botany and Plant Pathology, Michigan State University, East Lansing, MI. [Chapter 9]

BILL SCHEER is a cooperative extension agent with Washington State University, Tacoma, WA. [Chapter 15]

NANCY SCHULTE is a research specialist with the Department of Agricultural Engineering, Michigan State University, East Lansing, MI. [Chapter 4]

CARL SHANKS is a research entomologist with Washington State University, Vancouver, WA. [Chapter 8]

JAMES SPIERS is a plant breeder and nutritionist with the USDA in Poplarville, MS. [Chapter 4]

BERNADINE STRIK is an assistant professor and berry crop extension specialist with the Department of Horticulture at Oregon State University, Corvallis, OR. [Chapters 1 and 11]

WAYNE WILCOX is an associate professor with the Department of Plant Pathology at the New York Agricultural Experiment Station, Geneva, NY. [Chapter 9]

---

## LIST OF TABLES

---

1. Nutrient composition of an average one-cup (145 g) sample of blueberries (p. 6)
2. Worldwide highbush blueberry commercial production, 1989 (p. 7)
3. Effects of self-pollination and outcrossing on normal seed production and fruit weight in highbush blueberry varieties (p. 13)
4. Approximate amount of sulfur (pounds per acre) required to lower soil pH to 4.5 (p. 20)
5. Important characteristics of selected highbush varieties (p. 23)
6. Deficient, sufficient, and excessive nutrient concentrations in blueberry leaves (p. 103)
7. Recommended annual rates of nitrogen (pounds per acre) in a typical northeastern or midwestern blueberry planting (p. 105)
8. Fertilizer sources of major nutrients (p. 105)
9. Suggested micronutrient sources and application techniques (p. 107)
10. Natural deposits that can be used as fertilizers (p. 108)
11. Organic materials that can be used to decrease soil acidity (p. 108)
12. Nutrient content of organic materials used for macronutrient supplementation (p. 109)
13. Water source factors and their influence on drainage systems (p. 113)
14. Typical water-holding capacity for various soils (p. 114)
15. Monthly average potential evapotranspiration or peak use rate of water demand for July and August at various locations in the U.S. (p. 115)
16. Characteristics of different pump types (p. 130)
17. Typical blueberry harvest dates (p. 143)
18. Defect tolerances for fresh blueberries at shipping point (p. 153)
19. Defect tolerances for fresh berries en route or at destination (p. 154)
20. Frozen blueberry scoring for absence of defects (p. 155)
21. Summary of machinery ownership and operating costs (p. 158)

[continued on next page]

22. Schedule of operations and costs per acre from the Hudson Valley study (Year 1—Site Preparation) (p. 162)
23. Summary of production costs per acre from the Hudson Valley study (Year 1—Site Preparation) (p. 163)
24. Schedule of operations and costs per acre from the Hudson Valley study (Year 2—Planting) (p. 164)
25. Summary of production costs per acre from the Hudson Valley study (Year 2—Planting) (p. 165)
26. Schedule of operations and costs per acre from the Hudson Valley study (Year 9—Full Production) (p. 166)
27. Summary of production costs per acre from the Hudson Valley study (Year 9—Full Production) (p. 167)

---

# LIST OF FIGURES

---

1. A mature blueberry plant during the dormant season (p. 9)
2. Flower and vegetative buds on dormant shoot (p. 10)
3. Cross-section of a blueberry flower (p. 12)
4. Cross-section of a blueberry fruit (p. 13)
5. Hardwood cutting (p. 30)
6. Softwood cutting (p. 33)
7. Seasonal fluctuations in leaf nutrient concentrations (p. 104)
8. Average monthly precipitation and potential evapotranspiration at Aurora, NY, based on 5 years of data (p. 110)
9. Average weekly rainfall at Rochester, NY, based on 30 years of data (p. 111)
10. Probabilities of receiving at least 0.2, 1.0, and 2.0 inches of precipitation for the week indicated at Rochester, NY (p. 111)
11. Tensiometer (p. 126)
12. Relationship between soil type, saturation, and tensiometer reading (p. 126)
13. Uniform spray coverage on a blueberry leaf (p. 128)
14. Tractor- and trailer-mounted air-blast sprayers (p. 129)
15. Pumps used on air-blast sprayers (p. 130)
16. Sprayer nozzles (p. 131)
17. Axial-flow fan (p. 132)
18. Hand-held sprayers (p. 137)
19. Knapsack sprayer (p. 137)
20. Powered knapsack sprayer (p. 138)
21. Proper loading of a refrigerated trailer (p. 148)
22. Trends in North American blueberry production (p. 149)
23. Trends in raw-product blueberry prices (p. 150)
24. Utilization of 1989 North American blueberry production (p. 151)

# KEY TO PHOTOGRAPHS

---

- CHAPTER 1
1. Lowbush blueberry planting in Maine
  2. Lowbush blueberry fruit
  3. Rabbiteye blueberry planting in winter
  4. Rabbiteye blueberry fruit
  5. Highbush blueberry planting
  6. Highbush blueberry fruit
  7. Rabbiteye (Bonita and Beckyblue) and highbush (Sharpblue) fruit
  8. Young half-high blueberry plant (Northblue)
- CHAPTER 2
9. Flower and vegetative bud break on a shoot
  10. Spring bud break in a highbush blueberry
  11. Full bloom in a young planting
  12. New cane growth from crown in late spring
  13. Buds forming in axils of leaves in autumn
  14. Fibrous structure of a young root system
  15. Structure of a mature root system
  16. Flower clusters
  17. Cross section of a blueberry flower
  18. Bumblebee sonicating a flower
  19. Petal fall and fruit set
  20. Effects of self-pollination (third row) and outcrossing on fruit size in Spartan
  21. Fruit cluster of ripening berries
  22. Winter-injured shoot
  23. Winter-injured flower
  24. Frost-injured blossoms
  25. Flooded blueberry plants
  26. Raised bed culture

- CHAPTER 4 27. Stages of rooting in hardwood cuttings  
28. One-year-old plants rooted in lugs  
29. Container production of blueberry plants  
30. Screenhouse production  
31. Propagation beds  
32. Digging 2-year-old plants to sell  
33. Tissue-cultured plantlet
- CHAPTER 5 34. Newly planted blueberry field  
35. Young field with sod middles and sawdust mulch
- CHAPTER 6 36. Blueberry bush before pruning  
37. Blueberry bush after pruning  
38. Dead shoots remaining after cutting canes too high  
39. Bush after removing dead shoots  
40. Mature bush that has never been pruned  
41. Neglected planting  
42. Neglected planting after pruning  
43. Nectar robbing by honey bees
- CHAPTER 7 44. Netting for bird control  
45. Auditory frightening device  
46. Explosive sound device  
47. Eye-spot balloon  
48. Hawk-kite  
49. Owl model  
50. Slanted deer fence  
51. Meadow vole  
52. Woodchuck
- CHAPTER 8 53. Bud mite damage to fruit buds  
54. Cutworm  
55. Spanworm



56. Adult blossom weevil
57. Blossom weevil feeding injury
58. Cranberry fruitworm adult
59. Feeding site of cranberry fruitworm
60. Cherry fruitworm eggs
61. Adult blueberry maggot
62. Maggot-infested berry
63. Ovipositor entrance
64. Plum curculio oviposition scar
65. Green fruitworm
66. Japanese beetle adult
67. Rose chafer adult
68. Carpenter bees (left) and bumblebees (right)
69. Leafroller nest in fruit
70. Red-banded leafroller damage
71. Oblique-banded leafroller larva
72. Fruittree leafroller larva
73. Adult red-banded leafroller
74. Adult oblique-banded leafroller
75. Adult fruittree leafroller
76. Hatched egg mass of oblique-banded leafroller
77. Fruittree leafroller egg mass
78. Leafminer
79. Leafminer tepee tent
80. Sawfly larva
81. Datana worms
82. Sharp-nosed leafhopper egg scars and first instars
83. Sharp-nosed leafhopper fifth instar
84. Sharp-nosed leafhopper adult

85. Blueberry aphids
86. Tip borer injury symptoms
87. Stem gall
88. Putnam scale exposed on bark
89. Putnam scale on fruit
90. Terrapin scale
91. Blueberry stem borer
92. Adult root weevil
93. Root weevil grub
94. White grub
- CHAPTER 9
95. Cuttings from an area infested with stubby-root nematodes (right) compared with cuttings from a clean area (left)
96. Necrotic flower clusters in Pemberton infected with blueberry scorch carlavirus
97. Rod-shaped virus particles purified from blueberry scorch-diseased blueberry
98. A Berkeley bush infected with the blueberry shock ilarvirus
99. A leaf from a Berkeley bush infected with the blueberry shock ilarvirus
100. Spherical virus particles purified from blueberry infected with the blueberry shock ilarvirus
101. Sheep Pen Hill disease at bloom
102. Sheep Pen Hill disease during the first growth flush in plant on right
103. Later stages of Sheep Pen Hill disease in plant on right
104. Shoestring diseased leaves of Jersey
105. Shoestring diseased leaves of Jersey, showing crescent-shaped leaves and reddening
106. Shoestring diseased stem of Jersey showing elongate red streaks on wood
107. Shoestring diseased blossoms of Jersey with characteristic pinkish coloration
108. Leaves of Rubel infected with blueberry leaf mottle virus
109. Leaves of Jersey infected with blueberry leaf mottle virus

110. Necrotic ringspot in Pemberton exhibiting necrotic, shotholed and deformed leaves
111. Necrotic ringspot in Concord with small, rosetted leaves
112. Tomato ringspot virus–infected Earliblue leaves with mottles and spotting
113. Fruit of Rancocas infected with red ringspot virus; small light spots on surface
114. Leaves of Blueray infected with red ringspot virus. Spots may have green centers
115. Stem of Blueray infected with red ringspot virus
116. Leaves of Bluecrop infected with mosaic virus
117. Leaves of Coville showing a mosaic pattern probably caused by a genetic disorder
118. Blueberry stunt–diseased bush on right
119. A stunt diseased Jersey bush showing downward-cupped leaves with yellowish borders
120. Bluecrop leaves infected with stunt MLO
121. Alternaria fruit rot
122. Anthracnose fruit rot
123. Botrytis blight of flower clusters
124. Botrytis spores on blossoms
125. Fusicoccum canker injury
126. Stem symptoms of fusicoccum canker
127. Mummy berry shoot infection
128. Mummy berry spore formation on blighted shoots
129. Mummy berry infection of fruit
130. Interior of fruit infected with mummy berry
131. Fruiting body of mummy berry fungus
132. Phomopsis canker injury
133. Stem symptoms of phomopsis canker
134. Symptoms of stem canker
135. Powdery mildew

- 136. Witches' broom
- CHAPTER 10 137. Rotary hoe for weed control
- 138. Landscape fabric for weed control
- 139. Severe injury from glyphosate herbicide
- 140. Less severe injury from glyphosate
- 141. Injury from napropamide herbicide
- 142. Injury from simazine herbicide
- 143. Injury from terbacil herbicide
- 144. Injury from norflurazon herbicide
- 145. Clean cultivation
- 146. Grass middle and organic mulch
- 147. Fescue row middle
- CHAPTER 11 148. Nitrogen-deficient blueberry plant on right
- 149. Phosphorus deficiency symptoms
- 150. Potassium deficiency symptoms
- 151. Leaves of magnesium-deficient blueberry plant
- 152. Tip dieback caused by boron deficiency
- 153. Range of boron levels in soil as they affect leaves
- 154. Iron deficiency induced by high pH
- 155. Blueberry roots fed different sources of nitrogen
- CHAPTER 12 156. Sprinkler irrigation system in nursery
- 157. Sprinkler system for frost protection
- CHAPTER 13 158. Vertical boom sprayer
- 159. Vertical boom sprayer
- 160. Air mist sprayer
- 161. Air-blast sprayer
- CHAPTER 14 162. Hand-held harvester
- 163. Tractor-powered harvester
- 164. Self-propelled harvester

165. Sorting line

166. Flat of blueberries

CHAPTER 15 167. PYO blueberries

168. PYO checkout building

## INTRODUCTION

---

Blueberries and cranberries are the only two commercially cultivated fruit crops native to North America alone. Although wild blueberries were used extensively by indigenous people and early European settlers, they are among the most recently domesticated fruit crops. Three major cultivated types of blueberries exist: the lowbush blueberries of Maine and eastern Canada, the rabbiteye blueberries of the Deep South, and the highbush blueberries native to the eastern United States. Hybrids between these groups are also grown commercially. This production guide pertains only to the highbush blueberries.

Interest in blueberries as a cultivated crop began about a century ago, and after some pioneering cultural and breeding work by Frederick Coville and George Darrow, the industry developed at a phenomenal rate. Land once considered worthless for agriculture was found to be ideal for blueberry production. Today, North America has more than 40,000 acres of highbush blueberries. Currently, Michigan leads the nation in highbush blueberry production, followed by New Jersey. Other states that account for significant production are North Carolina, Oregon, Washington, Georgia, New York, Pennsylvania, Missouri, Indiana, and Arkansas. Highbush blueberries are also widely grown in British Columbia and Ontario.

Blueberries are sold fresh or frozen, or processed into jelly, juice, and dessert fillings. The ability to shift the production to either the fresh or processing markets has resulted in relatively high, stable prices for growers. Blueberries still rank high among the fruit crops used by consumers for the first time, indicating that the market is still growing.

Blueberries are an ideal crop for both small and large farms. Family labor can be utilized for many duties on the small farm, while many tasks on larger farms are mechanized. Blueberries have relatively few pest problems, so once the planting is established, maintenance costs are lower than for many other fruit crops. Blueberries can be grown organically in areas without large commercial production, and where disease-free planting stock is used.

A blueberry grower must consider many factors before investing in a planting. The first consideration is marketing; without a market, no profit can be made. The second consideration is economics, especially during the long payback period. Third is producing a crop. Those considering a blueberry operation will find *Farming Alternatives: A Guide to Evaluating the Feasibility of a New Farm-Based Enterprise* a valuable planning tool; it is available from NRAES, 152 Riley-Robb Hall, Ithaca, NY 14853; (607) 255-7654.

This *Highbush Blueberry Production Guide* is intended to aid the potential and established commercial grower in all aspects of blueberry production, from site preparation through plant selection, planting, plant training, pest and disease control, nutrient and moisture management, harvest, marketing, and economics. More than fifty researchers, extension workers, and growers

from 17 states contributed to this guide, so it is truly comprehensive in scope. Its three-ring format allows the owner to add information from other sources.

## **Using the Guide**

---

The guide is organized into 16 chapters. Chapters 1 and 2 acquaint the reader with the origin of the cultivated blueberry and with terms that are used throughout the guide. Some of these involve scientific concepts that may not be familiar to the grower, but they are concise descriptions of plant parts or physiological processes.

Chapters 3 through 5 should be read by growers who are preparing to plant blueberries for the first time, or growers who are planning to expand their acreage or replant. These chapters contain information that is not yet widely available in North America.

Chapters 6 through 10 are written for growers of established plantings. Chapter 6 describes the care of blueberry plants, and chapters 7 through 10 discuss pest management. Since blueberries are a relatively minor crop, integrated pest management plans are not well developed for all growing regions. However, these chapters can assist with the development of an IPM program for an individual farm. This section is best used in conjunction with the photographs.

Chapters 11 and 12 involve the management of nonliving factors in the blueberry planting—nutrients and water. The appendixes supplement chapter 11 for those interested in understanding soil test recommendations and the injection of chemicals through irrigation systems.

Chapters 12 through 14 involve engineering principles. Water drainage and spray application are particularly important in the 1990s with the realization that environmental degradation can result from improper practices. Proper harvesting and handling are essential, for it does the grower no good to grow a beautiful crop of blueberries only to have them rejected at the market because of poor handling.

Chapters 15 and 16 should be read by anyone considering blueberry production for the first time. Identification of a market should be the first step when contemplating a blueberry operation. Budgeting is typically the most neglected aspect of the farm enterprise, but knowing the costs of production is important for making wise management decisions.

The Key to Blueberry Problems integrates much information about disorders by grouping them into categories based on symptoms. Here a grower can find a list of the most likely causes of a particular problem, and use the key to identify the specific cause. The key includes some information not presented in any chapter.

English measurements are used throughout the text; an English-to-metric conversion table is included on page 179.

The color photographs beginning on page 180 are the best collection yet assembled for blueberries. Many individuals contributed to this collection, making it perhaps the most useful part of this publication.

The glossary beginning on page 195 defines terms used by blueberry growers and researchers; some definitions cite illustrations that clarify the term's meaning.

Many chapters end with a list of resources. The guide also includes a list of other information currently available on blueberries. Some items on this list might be useful for growers in specific regions of the United States.

The editors hope this guide will be easy to use, and have planned it to be the most comprehensive source of information available to the blueberry grower.



## Chapter 1

# THE Highbush BLUEBERRY

---

## Taxonomy

---

Blueberries are members of the Ericaceae family, which also includes rhododendron, azalea, Indian pipe, heath, cranberry, and huckleberry. Most members of this family require acid soils for good growth and reproduction. Ericaceous plants are also known for the symbiotic relationship that has evolved with endomycorrhizal fungi. The fungi inhabit the roots of ericaceous plants and aid in water and nutrient uptake while using carbohydrates in the plant as a food source. This association helps ericaceous plants to inhabit nutrient-poor environments; they are often found in the drier areas of bogs where other plants cannot survive. However, these fungi may not be found in plantings where cultivation and inorganic fertilizers are used extensively.

The Ericaceae family is divided into four subfamilies: the Vaccinioideae contains the genus *Vaccinium* which, in turn, contains the subgenus *Cyanococcus*—the true (or cluster-fruited) blueberries. Within *Vaccinium* are approximately 400 species, most of which occur in Malaysia. The 26 species that occur in North America include whortleberries, deerberries, bilberries, sparkleberries, cranberries, lingonberries, and blueberries. The ten-seeded fruit of the huckleberry (*Gaylussacia* spp.) is often confused with the many-seeded blueberry fruit, but these plants are in different genera.

Three major types of blueberries are harvested commercially. The lowbush blueberry (*V. angustifolium* and, to some extent, *V. myrtilloides*) (photos 1–2) is harvested from managed wild stands in the eastern provinces of Canada and the northeastern United States. The rabbiteye blueberry (*V. ashei*) is grown in the southeastern United States (photos 3–4). The highbush blueberry (*V. corymbosum*) is the major cultivated species in North America (photos 5–7). It occurs in native stands from southern Nova Scotia west to southern Wisconsin and south along the Atlantic Coast and to eastern Texas.

Mature highbush plants are 6 to 8 feet tall. Several canes are produced from the crown each spring, and canes live for many years. Flower buds form in the fall, and plants produce fruit about 2 months after flowering in spring. Yields have been reported to be more than 25,000 pounds per acre, although more typical yields in a well-managed commercial planting range from 4,000 to 6,000 pounds per acre. Fruits typically weigh 1 to 2 grams each, up to 4 grams for certain varieties under ideal conditions.

That blueberries and cranberries are the only commercially grown endemic fruit crops has several implications for cultivation. First, there are no major imported insect or disease pests of blueberry. Second, the blueberry flower is not easily pollinated by the honey bee, which evolved in Europe and Asia, so native wild bees are the most effective pollinators where they are available in sufficient numbers.

## History

---

Wild blueberries make up a significant portion of the diets of chipmunks, bears, and several bird species. Before the arrival of Europeans in North America, indigenous people dried the fruit for use in winter. Because highbush blueberries were not familiar to Europeans, the fruit received little attention from agriculturists until the late 1800s. The blueberry is one of the most recently cultivated major fruit crops, having been domesticated entirely within the 20th century.

In the first step towards domestication, wild selections were transplanted into backyards and fields. One of the earliest stands (c.1850) of transplanted blueberries is on the grounds of the Smithsonian Institution. Another early planting (1893) was made in Michigan by Mrs. Anson Gass. Elizabeth White of Whitesbog, New Jersey, was a commercial cranberry grower who convinced her workers through monetary incentives to search for exceptional blueberry bushes in the wild and transplant them to her farm. Over the years she collected many plants which would later be used in breeding programs. While these wild plants were being collected, limited cultural work was beginning at several state experiment stations. Researchers established the need for acid soils, good drainage, a chilling requirement, and insect pollination, and found that blueberries could be propagated by cuttings. This information provided the basis for subsequent breeding advances.

Dr. Frederick Coville, botanist and plant breeder for the United States Department of Agriculture, provided leadership for the first blueberry breeding program. He made some initial selections in 1908 from native plants in New Hampshire and performed his first successful hybridization in 1911. That same year, White permitted Coville to use her farm, and by 1937 they had released 8 varieties from wild selections and 15 improved varieties derived from controlled crosses. By 1959, the number of improved varieties directly attributed to Coville had risen to 30. Many of these are still widely grown.

George Darrow assumed leadership of the USDA blueberry breeding program after Coville, and began to coordinate cooperative research with the state experiment stations and private growers. Although the blueberry industry began in New Jersey, Stanley Johnston, professor at Michigan Agricultural College, stimulated considerable interest in growing blueberries along the eastern shore of Lake Michigan where soils were ideal for the blueberry. This land was considered to be too poor for agriculture, so it was purchased for a low price by potential blueberry growers. Although blueberry production was successful there, major markets were several hundred miles away. The Michigan Blueberry Growers' Association was formed in 1936 for the purpose of shipping berries to Chicago, Detroit, and Toledo. It was patterned after the successful New Jersey growers' cooperative. Today, marketing is coordinated with southern growers in Arkansas and Florida to supply worldwide markets.

In the 1930s, growers and scientists from New Jersey began to realize that the acidic sandy soil in North Carolina would probably support highbush blueberry production. Stem canker became a serious problem in this region, so a breeding program with an objective of developing resistant varieties was

initiated in the 1940s. By the 1950s, the first resistant varieties were released. The emphasis of the industry has been to supply fresh fruit in May to the population centers in the East.

In the 1930s and 1940s, growers began to plant highbush blueberries in the peaty areas around Puget Sound, Puyallup, Washington, and then in other parts of Washington and Oregon. The crop was mainly harvested fresh for local and California markets. Now a fair portion of the crop is processed.

Scientists in the land-grant university system have also been interested in blueberry production. Today, breeding programs exist in Michigan, New Jersey, North Carolina, Maryland, Minnesota, Arkansas, Mississippi, Texas, and Florida. Canada, several European countries, New Zealand, and Australia also have breeding programs. Major breeding objectives are sweet, intense fruit flavor, large fruit size, small fruit scar, light blue color, winter hardiness, drought resistance, wide climatic adaptation, broad soil adaptation, disease resistance, erect habit, adaptability to mechanical harvesting, and late flowering coupled with early ripening. Interspecific hybridization has been used in some cases to achieve these objectives. For example, several smaller-statured, winter hardy varieties (photo 8) have been derived from crosses made with the lowbush blueberry (see chapter 4). Incorporation of drought tolerance, low chilling and early ripening has been achieved through gene transfer with rabbiteye blueberries and other native species, such as *V. darrowii*.

**Table 1.** Nutrient composition of an average one-cup (145 g) sample of blueberries.

CONSTITUENT	FRESH	FROZEN, unsweetened
Water	123 g	134 g
Calories	82 kcal	78 kcal
Protein	0.97 g	0.65 g
Fat	0.55 g	0.99 g
Carbohydrate	20.5 g	18.9 g
Fiber	1.88 g	2.32 g
Calcium	9 mg	12 mg
Iron	0.24 mg	0.28 mg
Magnesium	7 mg	8 mg
Phosphorus	15 mg	18 mg
Potassium	129 mg	83 mg
Sodium	9 mg	1 mg
Zinc	0.16 mg	0.11 mg
Copper	0.09 mg	0.05 mg
Manganese	0.41 mg	0.23 mg
Ascorbic acid	18.9 mg	3.8 mg
Thiamin	0.07 mg	0.05 mg
Riboflavin	0.073 mg	0.057 mg
Niacin	0.52 mg	0.81 mg
Pantothenic acid	0.135 mg	0.194 mg
Vitamin B <sub>6</sub>	0.052 mg	0.091 mg
Folacin	9.3 mg	10.4 mg
Vitamin A	145 IU	126 IU

Current cultural research in North America includes developing practices for specific regions. Among the problems in the larger production areas are treating and reducing disease and insect attacks, and preventing stress-related injuries from extreme temperatures, drought, excessive rainfall, or frost.

The blueberry fruit has many desirable traits including small edible seeds, ease of preparation, and a fairly long shelf life. These traits, together with the blueberry's unique flavor and its ability to be mechanically harvested, have led to rapid acceptance of the fruit among consumers. Blueberries can be eaten fresh or used for jelly, jam, syrup, pies, pastries, or juice. Blueberry fruit is also low in calories and sodium, contains no cholesterol, and is an excellent source of fiber (table 1). A major constituent of the fiber in blueberry is pectin, known for its ability to lower blood cholesterol levels. Blueberries contain measurable quantities of ellagic acid, which has inhibiting effects on chemically induced cancer in laboratory studies. Blueberry juice also contains a compound that prevents bacteria from anchoring themselves in the bladder, thereby helping to prevent urinary tract infections. For these

reasons, the highbush blueberry has been planted throughout the world where the climate is suitable.

The success of blueberries has been phenomenal; the acreage planted to blueberries has increased faster than for any other temperate fruit crop. In 1930, about 200 acres were cultivated; today more than 40,000 acres are cultivated in North America alone. In addition, lowbush and rabbiteye blueberries are produced on a large scale in certain regions such that overall production has nearly doubled over the last 15 years. The largest highbush production regions in North America are Michigan, New Jersey, the Pacific Northwest, North Carolina, the south central states, and the northeastern states. Europe, West Germany, France, Poland, and southern England have young industries, and in the Southern Hemisphere, South Africa, New Zealand, Australia, and Chile also produce blueberries. The highbush industry in North America is worth more than \$100 million as Americans consume nearly 200 million pounds of blueberries each year (table 2).

**Table 2.** Worldwide highbush blueberry commercial production, 1989.

COUNTRY (State/Province)	ACRES	PRODUCTION (millions of pounds)	COUNTRY	ACRES
<b>U.S.A.</b>			<b>Australia</b>	225
Michigan	15,100	60.1	<b>Chile</b>	75
New Jersey	9,700	40.0	<b>France</b>	65
North Carolina	4,300	10.0	<b>Germany</b>	650
Oregon	1,370	11.2	<b>Holland</b>	500
New York	1,000	7.0	<b>Italy</b>	40
Washington	900	6.3	<b>New Zealand</b>	1,000
Georgia	850	2.6	<b>Poland</b>	350
New England <sup>1</sup>	1,250	4.5	<b>South Africa</b>	320
Others <sup>2</sup>	4,680	15.0		
<b>Total</b>	<b>39,150</b>	<b>156.7</b>	<b>TOTAL (World)</b>	<b>47,175</b>
<b>Canada</b>				
British Columbia	4,000	16.0		
Ontario	600	2.0		
Quebec	200	0.5		
<b>Total</b> (North America)	<b>43,950</b>	<b>175.2</b>		

<sup>1</sup> Includes CT, MA, ME, NH, RI, VT  
<sup>2</sup> Includes AR, MO, OK, PA, KY, SC, MD, VA, FL, IL, IN, OH.

Sources: Holbein J. P., 1989, *NABC Statistical Record*; Eck, P., 1988, *Blueberry Science*; Hanson, E. J., and J. F. Hancock, 1990, "Highbush Blueberry Varieties and Production Trends," *Fruit Var. J.* 44:77-81.

## **For More Information**

---

Buszek, B.R. *The Blueberry Connection: Blueberry Cookery*. Brattleboro, Vermont: Stephen Greene Press, 1980.

Eck, P. *Blueberry Science*. New Brunswick, New Jersey: Rutgers University Press, 1988.

Eck, P. and N. F. Childers. *Blueberry Culture*. Rahway, New Jersey: Quinn and Boden, 1966.

Eck, P., R. E. Gough, I. V. Hall and J. M. Spiers. "Blueberry Management." In: Galletta, G. and D. Himelrick, eds. *Small Fruit Crop Management*. Englewood Cliffs, New Jersey: Prentice-Hall, 1990.

Vander Kloet, S. P. *The genus Vaccinium in North America*. Ag Canada Publication 1828. Ottawa: Agriculture Canada, 1988.

## Chapter 2

# BLUEBERRY GROWTH AND DEVELOPMENT

Learning how the blueberry plant grows and responds to the environment is important in understanding why certain cultural practices are recommended. The terms used for plant parts and physiological processes are described in this chapter. By developing a common terminology, growers, extension workers, and researchers can communicate clearly and concisely (figure 1).

An overview of the growth of the blueberry plant is followed by discussions of specific plant systems. Because plant development differs from year to year and from location to location, references are made to stages of growth, rather than to specific times of the year. Beginning at winter dormancy, the sequence of development is bud swell, bud break, shoot elongation, flowering, fertilization, fruit set, petal fall, fruit swell, fruit coloring, harvest, terminal growth cessation, bud initiation, bud differentiation, leaf coloring, leaf abscission, and dormancy. Beginning at flowering, new canes elongate from the base of the plant; they cease terminal growth in late summer. Bud initiation occurs simultaneously on new canes and older canes.

Environmental stresses can affect these stages of development. The major stresses are temperature extremes, drought, and flooding.

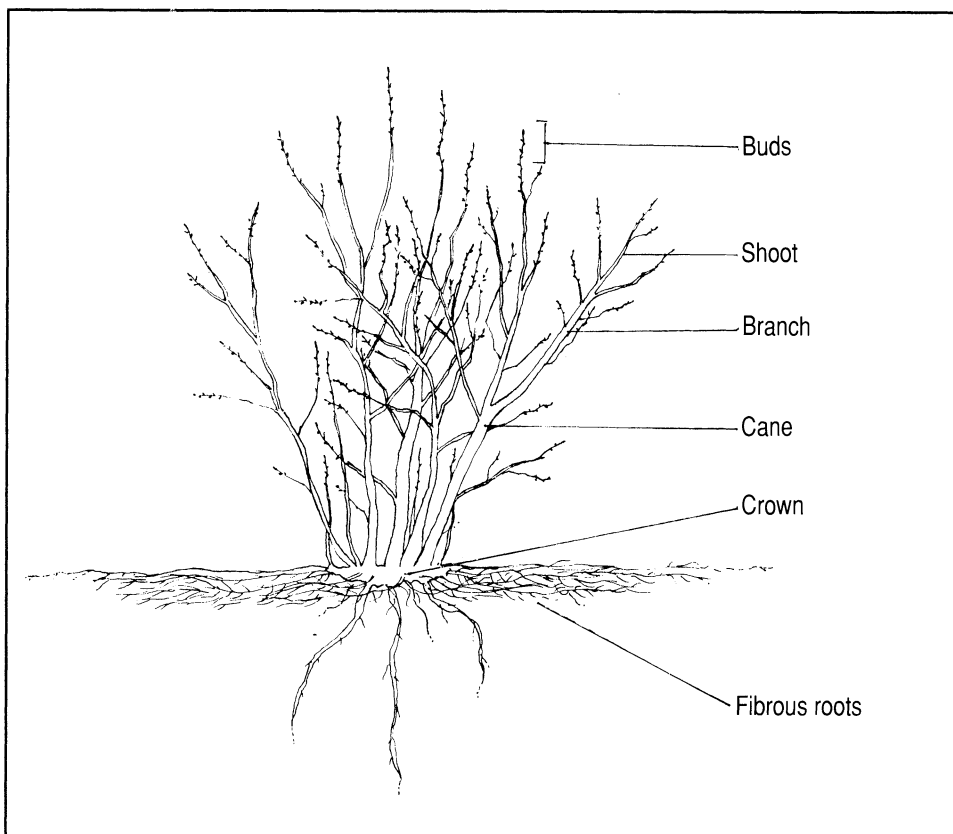

**Figure 1.** A mature blueberry plant during the dormant season.

## Plant Growth Habit

The cultivated highbush blueberry is a deciduous shrub, ranging in height from less than 3 feet for certain highbush x lowbush hybrids to 6 to 8 feet for most common commercial highbush varieties. Vegetative growth of the blueberry begins with bud swell in early spring, and continues late into the summer or early fall. Shoots grow in flushes of rapid growth, stopping as the apical bud aborts. After a bud near the tip of the shoot breaks, another flush will begin. Each shoot may have several flushes during the season, and each may grow to 6 to 10 inches with adequate moisture and nutrition. Shoot extension growth ceases in midsummer and some of the small, narrow, pointed vegetative buds will differentiate into large, almost spherical flower buds (figure 2). Typically, 5 to 8 flower buds develop down the shoot, beginning at its tip. Each bud contains 5 to 10 potential flowers, which continue to form into the fall, ceasing with the onset of colder weather. Both types of buds enter a period of dormancy, normally broken only after a chilling period of 600–1,000 hours below 45°F. Warm weather in early spring activates growth (photos 9–11).

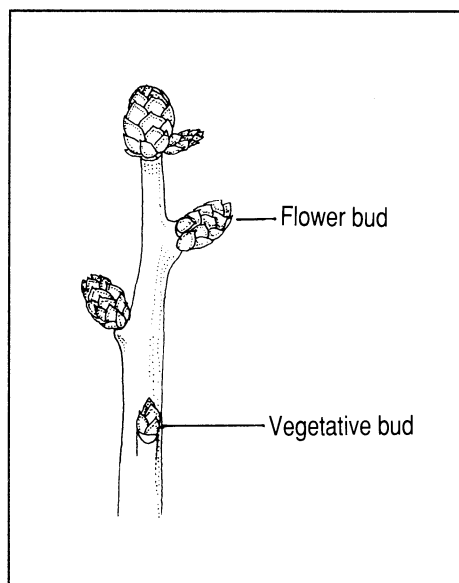

**Figure 2.** Flower and vegetative buds on dormant shoot.

The required chilling period is usually met by the middle of winter, after which time dormancy is maintained by cold temperatures. If this chilling requirement is met and a midwinter thaw (several days over 45°F) occurs, blueberry buds may lose some of their hardiness; a sudden return of colder temperatures may result in cold temperature injury.

New canes develop from the crown of the blueberry plant in early spring (photo 12). As few as one or none may emerge from the crowns of certain varieties such as Jersey, while several dozen may emerge from the crown of Northland. These shoots are extremely vigorous, often growing 3 feet or more in a first growth flush. A second, less vigorous flush of growth may begin in midsummer and continue late into the fall, when it may be injured by cold temperatures, particularly in northern locations. These young canes may set a terminal cluster of flower buds in the fall.

Blueberry leaves respond to changes in day length and temperatures with the development of fall leaf color that ranges from yellow to crimson to dark red, depending on variety (photo 13). This color change is due in part to the loss of chlorophyll from the leaves and the production of red color pigments as the leaf senesces. Changes in leaf color in early spring and summer may occur after periods of cool temperatures. Color development at this time is generally a dull purple over a dark-green background and may last for several days after warm weather resumes.

## Root System

The blueberry root system is composed primarily of fine, fibrous roots near the soil surface. Some larger roots can be found at depths of 3 feet in some soils, but this is unusual. The fibrous roots lack root hairs typically found on most other plants, so the root system has a relatively low absorptive capacity

(photo 14). Blueberry roots, however, have an intimate association with endomycorrhizal fungi. These fungi live partially within the outer cells of the root and partially in the surrounding soil. The portion of the fungus that protrudes from the root aids in nutrient and water uptake. These fungi are destroyed by clean cultivation and mineral fertilizer applications over an extended period.

Roots begin to grow in spring when soil temperatures in the root zone reach approximately 43°F, usually as buds begin to swell. Growth continues through late spring when root zone temperatures reach approximately 60°F. Root activity subsides as berries mature and ripen. Once harvest is complete, roots again become active, apparently making most of their growth in early autumn when soil temperatures again approach 60°F, and ceasing when soil temperatures drop to 43°F.

Recommended times for fertilizing blueberries are determined in part by root growth activity. Fertilizer is generally applied in early spring when root growth begins, and in some cases in late spring when root growth activity peaks. Fertilizer is applied within the dripline of the bush, where over 90% of the roots are located.

Most blueberry roots are located in the top 8 to 12 inches of soil, with rooting rarely below 16 inches in most sites (photo 15). Because of their fine, fibrous structure, they cannot penetrate compacted soils; the soil must be porous and open. This fibrous root structure limits the tolerance of the highbush blueberry plant to excessively dry or wet soil conditions and limits its ability to absorb soil nutrients. The blueberry grows best in sandy loams or acidic sands rich in organic matter. The organic matter improves root penetration through the soil structure and maintain soil moisture and nutrients. Organic mulches are commonly used to increase the growth and yield of highbush blueberry on mineral soils. Organic mulches moderate soil temperatures, keeping them near 60°F, at which root growth is most active, for a longer time (see chapter 6).

## **Flowering**

---

The highbush blueberry can flower over a considerable length of time. A single variety can bloom for 7 to 14 days, depending on environmental conditions. Plants of early-blooming varieties, such as *Bluetta*, tend to have a longer flowering period than later-blooming varieties, such as *Elliott*. While this may be determined in part by genetics, it is also influenced by temperature. Those varieties that bloom earlier are doing so under generally cooler temperatures, and therefore, may have a longer bloom period.

Flower bud position also influences the time of bloom. Flower buds on a shoot open sequentially with the flower bud at the tip of the shoot opening first, followed by the one just beneath, and so on down the shoot (photo 10). The individual flowers within each bud open in a similar sequence with the flower near the tip of the cluster opening first (photo 16). Shoot thickness affects blooming sequence; blossoms on thin wood open before those on thick wood.

### **Flower Morphology**

Blueberry flowers have many characteristics that discourage self-pollination and encourage cross-pollination. These include a small flower opening that



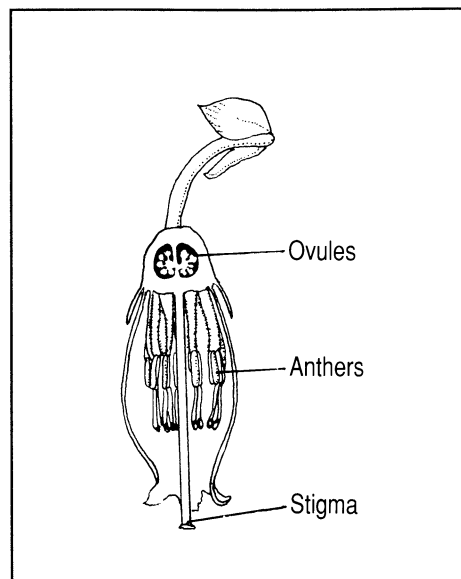

**Figure 3.** Cross-section of a blueberry flower.

shields reproductive structures from wind and rain, preventing pollen from being blown onto its own stigma; an inverted flower structure that deflects falling pollen from the stigma; heavy pollen that is not wind-borne; and fragrant, sweet flowers that attract insects (figure 3; photo 17). A visiting insect crawling through the small flower opening will first encounter the receptive stigmatic surface (depositing pollen from other plants), then the anthers containing the pollen (to carry to another plant), and then the nectar. Pollen is dislodged from the anthers through sonication, a vibrating process carried out by certain bees (photo 18). Because a blueberry can have up to several dozen seeds, each of which requires a pollen grain for its development, good pollination is important.

The stigma (the receptive portion of the female reproductive tissue) and ovules (which, when fertilized, develop into seeds) within the blueberry flower remain receptive to pollen for only a few days after the blossom opens. Researchers have found that if pollination does not occur within 3 to 6 days, fruit set is not likely to occur. Growers often saturate the planting with bees early in

the bloom period to ensure adequate fruit set (see chapter 6). Pollinated flowers remain white and usually drop within 4 or 5 days after bloom (photo 19). Flowers that have not been pollinated within the critical few days after opening may remain on the bush for up to 12 days, often turning a wine color.

Pollen germinates soon after landing on the stigma, and the pollen tube begins growing down the hollow style. Upon reaching the egg sac after a journey that may take a day or more, the tube ruptures. It releases two sperm, one of which unites with the egg to form an embryo while the other unites with two other female nuclei to produce endosperm tissue. This tissue nurtures the embryo as it develops. When this occurs, the outer coating of the ovule begins to change, eventually forming the hardened seed coat. In general, with better cross-pollination, more seeds develop, resulting in larger fruit (table 3, next page).

Certain varieties including Earliblue, Stanley, Coville, and half-high types may be partially self-unfruitful. Research has shown that cross-pollination increases fruit production for many varieties, resulting in earlier ripening and larger berries (photo 20).

## **Fruit**

The blueberry fruit develops from an inferior ovary into a many-seeded berry (figure 4; photo 21). Fruit ripens 2–3 months after bloom, depending on the variety, weather conditions, and plant vigor. Thicker wood often produces berries that are larger and that mature earlier than fruit produced on thinner wood. The sugar content of green fruit is approximately 7%, increasing to as much as 15% when fruit is ripe. This sugar is manufactured by the leaves and transported to the fruit. Sugar levels continue to increase for several days after the fruit turns blue.

Fruit size increases by as much as 35% after the berries turn blue, due to the movement of water into the fruit. The ripe blueberry fruit is about 85% water.

**Table 3.** Effects of self-pollination and outcrossing on normal seed production and fruit weight in highbush blueberry varieties.<sup>1</sup>

VARIETY		NUMBER OF SEEDS	FRUIT WEIGHT (g)
Bluecrop	selfed	10.8	1.87
	outcrossed	26.7	2.36
Bluejay	selfed	6.2	1.09
	outcrossed	9.8	1.14
Elliott	selfed	7.7	1.60
	outcrossed	43.7	2.03
Jersey	selfed	15.1	1.16
	outcrossed	48.4	1.64
Rubel	selfed	11.8	0.82
	outcrossed	22.7	0.96
Spartan	selfed	1.3	1.91
	outcrossed	9.4	2.50

<sup>1</sup>Flowers of field-grown varieties were hand pollinated with their own pollen and mixtures.

Michigan data from Steve Krebs, Department of Horticulture, Michigan State University.

Drought conditions during fruit ripening will reduce fruit size and may affect fruit flavor.

Ripening is very closely linked to blueberry fruit quality. The ripening process involves major changes in the fruit. Color changes are dramatic as the fruit synthesizes large quantities of pigments. Changes in the cell walls result in fruit softening; this softening is desirable, as it improves the palatability of the fruit, but becomes less so as the fruit becomes more vulnerable to physical damage. The accumulation of sugars results in increasing fruit sweetness. Since blueberries contain little starch that can be converted to sugar after harvest, they will never be any sweeter than they are at the time of harvest. Blueberry fruit acids are broken down during ripening, so the fruit loses

tartness. Fruit flavor, associated mainly with the area just beneath the skin of the fruit, also increases during ripening and, like sweetness, does not increase after harvest. Finally, the ability of the fruit to resist invasion by the various fruit rots decreases as the fruit ripens. Fruit quality can only decrease after harvest, but certain varieties retain their firmness and flavor longer than others.

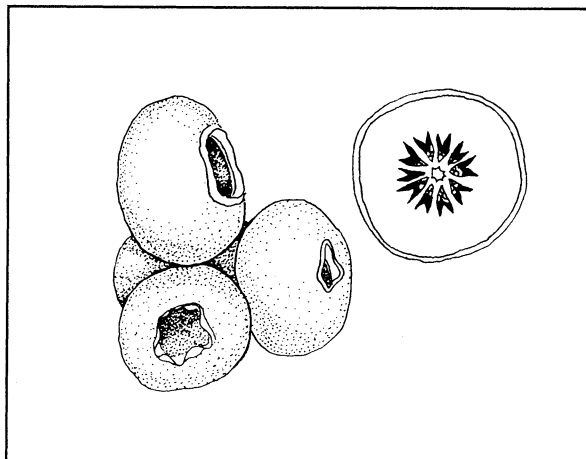

**Figure 4.** Cross-section of a blueberry fruit.

The highest quality blueberries are obtained if fruit is allowed to ripen fully on the plant. Unfortunately, these fully ripe fruits inherently have a very short postharvest life. Extending this postharvest life requires controlling storage temperature and humidity. Reducing the temperature from 85°F to 32°F will slow the rate of change (and extend the postharvest life) of

the harvested fruit by some 12-fold. In addition, these lower temperatures will reduce the development rate of the rot organisms, further protecting fruit quality. To maximize the advantages of refrigeration, fruit needs to be chilled to the desired storage temperature as soon as possible after harvest (see chapter 14).

## **Environmental Stress**

---

Extremes in temperature and moisture are the most important abiotic stresses a blueberry plant encounters. The ability of a plant to tolerate an environmental stress depends in part on the time of the year when the stress occurs, the overall health of the plant, and environmental conditions preceding the stress.

**Temperature Tolerance** Blueberry plants can tolerate some temperature fluctuation, and can slowly acclimate to cold temperatures in autumn and warm temperatures in spring. However, temperature extremes can affect growth and development and may damage vegetative and reproductive tissue.

**Cold Hardiness** The tolerance of blueberries to cold temperatures between growing seasons varies tremendously among species and varieties. The degree to which a blueberry bush hardens off depends upon many factors, including length of the growing season, alternating day and night temperatures, nutrition, pruning, and fluctuating temperatures during the dormant season. Actively growing tissues are not cold hardy and are injured by temperatures around 28°F. As the days become shorter and the temperatures cooler during the fall, blueberry canes cease active growth and begin a complex process known as acclimation. Optimum cold hardiness develops after day/night temperatures decrease steadily from midsummer to late fall, followed by several mild frosts. The degree of cold hardiness varies in relation to temperature, throughout the dormant season. Maximum cold hardiness occurs after fully acclimated plants have been exposed continuously to several days of nonlethal, subfreezing temperatures. Plants lose hardiness during periods when temperatures rise above freezing. Most freezing injury occurs when temperatures fluctuate above and below freezing, and are typically associated with subfreezing temperatures that follow midwinter thaws. Because of generally mild and fluctuating winter and early spring temperatures in the coastal areas of Oregon and Washington and the Southeast, blueberries in those areas seldom attain maximum cold hardiness.

Improper cultural practices, environmental stresses, and damage from pests and diseases can interfere with acclimation and inhibit the development of cold hardiness. Proper fertilization practices greatly enhance acclimation and hardening (see chapter 11). Excessive or late fertilization with nitrogen forces late-season growth that is susceptible to early fall frosts. In general, nitrogen fertilizers should not be applied after midsummer.

Pruning too early in the fall interferes with cold acclimation by stimulating late growth. Even if no visible growth develops, early pruning can cause the cane tissues to deacclimate. Pruning should be delayed until the canes are fully dormant. Pruning during the late winter and early spring reduces the likelihood of freezing injury and allows growers to identify and remove injured wood and buds.

Although research indicates that maximum cold hardiness is related to drought stress in some woody species, blueberry plants should not be allowed to become drought stressed during the growing season or dormancy. On drier sites, irrigate deeply before the ground freezes to provide enough moisture to supply and protect the blueberries during the winter.

Acclimation and hardening are active, energy-intensive processes that depend upon the food reserves of a plant. These food reserves are produced in the leaves by photosynthesis. Insect damage, disease, and other stresses that damage foliage limit the production of food reserves and acclimation. An important step in minimizing winter injury is to maintain a healthy canopy of foliage by controlling pests and diseases. Overcropping puts a tremendous strain on the food reserves of a blueberry bush, and should be avoided by proper pruning and crop control.

If plants are relatively unstressed and hardening has occurred properly, then the following varieties can withstand the corresponding midwinter low temperatures: Northcountry, Northblue, Northland, Northsky, Patriot, Rancocas, Rubel, and St. Cloud (-35°F); Bluecrop, Bluejay, Blueray, Earliblue, Elliott, Herbert, Jersey, Lateblue, Meader and Toro (-30°F); Berkeley, Bluehaven, Bluetta, Burlington, Collins, Coville, Darrow, Duke, and Spartan (-20°F); and Bluechip (-10°F) (see table 5, pages 23–24).

Not all of the tissues of a blueberry plant attain the same degree of cold hardiness. In fully acclimated plants, the wood is normally somewhat hardier than the buds, and the roots do not develop any degree of cold hardiness. Mulching with bark or sawdust can help to moderate root zone temperatures and minimize root freezing injury.

The basal region, which connects the flower buds to the shoot, is the part of the bud that is most easily injured during the early dormant period. Following a freeze, florets in a bud may show no injury even though the basal tissues are injured. The amount of growth that a new shoot or flower cluster makes depends upon the amount of injury the bud base has experienced. If the injuries restrict the flow of nutrients and water, the growth of the shoot or flower cluster is slow and restricted, or completely inhibited (photos 22–23). Injury to the basal tissues can be determined by slicing through a bud from the tip through the bud base with a sharp razor blade. Freeze-injured tissues have a brown, water-soaked appearance; healthy tissues are green or white. For best results, wrap tissues to be tested in a plastic bag and hold at room temperature for several days before examining for browning.

As the vascular connections between the wood and bud develop during the late winter and early spring, the florets begin to lose their hardiness. When the flower buds begin swelling in the early spring, the florets are the most easily injured part of the bud. Once a flower bud opens, it has lost most of its cold hardiness and will be injured at 23°F (photo 24). Tip buds on a cane and tip florets are the first to develop and are the most susceptible to early frosts.

To reduce spring frost injury, avoid planting in frost pockets and ensure good drainage of cold air by removing cold air dams formed by trees and brush around blueberry fields. In regions where spring frosts are a problem, select planting sites on gently sloping hillsides and benches. Overhead sprinkler

systems are effective in reducing spring frost injury (see chapter 12). The selection of late-blooming varieties can also lessen frost injury. In general, fruiting date is strongly associated with bloom date, so that later flowering types also produce late fruit. Duke and Spartan are exceptions in that they fruit early, but bloom later than other early varieties do.

Freezing injury to the cane wood or roots interferes with the movement of water and nutrients to the buds. Symptoms may not appear until early summer; bushes can bloom, leaf out, and even begin setting fruit before suddenly collapsing and dying over 1 or 2 days. Sudden collapse is usually correlated with the onset of hot weather, which increases the demand for water by the developing shoots and fruit. Injured vascular tissues are unable to supply the needed water and the plant collapses.

**Warm Temperatures** During the growing season, highbush blueberries can withstand ambient temperatures of 90 to 100°F. Above these temperatures they may begin to desiccate because roots cannot absorb enough water to sustain the plant. Blueberry leaves have a fairly high resistance to water loss, so the cooling effect of transpiration is less than for many other crops. Therefore, hot temperatures coupled with moisture deficits are detrimental. Evaporative cooling can alleviate some of the stress on the plants; sprinkler irrigation should be turned off in time for moisture on leaves to evaporate before nightfall.

Flowering, fruit set, and fruit development can be adversely affected by high temperature; in most blueberry growing regions, though, cooler temperatures during these stages are a greater cause of concern. Bud development will be slower under cool temperatures in summer, and pollen germination is slower when temperatures are cool in spring, reducing fruit set. Fruit development will also be delayed if temperatures are unseasonably cool during late spring.

**Moisture Tolerance** Water is essential for plant growth and development; water comprises 85% of plant tissues and it is needed for uptake of nutrients and evaporative cooling. Plants that experience severe drought stress may not recover. Excess water is also detrimental, especially when pathogens are present in the soil.

**Drought Stress** Blueberry leaves resist the passage of water from inside to the surrounding air, in part because of the relatively heavy layer of wax on the leaves. This layer helps prevent the plant from drying out, but when exposed to even moderate drought stress, the blueberry stomata close. When stomata close, water loss is reduced further, but growth also ceases because carbon dioxide can no longer enter the leaf. Therefore, for good growth and development, adequate moisture must be supplied to the blueberry plants at all times so the stomata can remain open.

**Flooding** Blueberries can tolerate some flooding during dormancy, but none during active growth when the soil must be well aerated. Flooded soil contains no oxygen for use in respiration, so roots begin to accumulate toxic metabolites which can eventually kill the plants (photo 25). Physiological processes are affected within a few days of flooding; warm, wet soils promote phytophthora root rot. Growers should not plant blueberries on soils that tend to flood. Raised beds (photo 26) can alleviate stress from temporary flooding. Highbush blueberries are least able to withstand flooding in April, a time of rapid root growth requiring a maximum amount of aeration.

## Chapter 3

# SITE SELECTION AND PREPARATION

---

Selecting a good site for a blueberry planting is one of the most important decisions that a grower will make. The high establishment costs and potential longevity of the planting make this decision crucial.

Blueberries have more specific site and soil requirements than most other crops. Ideal blueberry sites are found only in very specific regions of the world; however, the grower can extend the range of suitable land through proper soil modification, mulching, and use of irrigation.

**Climate** The northern limit of production is determined by the length of growing season and minimum winter temperatures. A growing season of at least 160 days is necessary for sustained crop production. Flower buds of most true highbush varieties can tolerate temperatures to -15°F in midwinter (see page 14 and chapter 4). The vegetative buds and woody tissue are tolerant to -20°F. Half-high blueberries are tolerant to -0°F if snowfall is sufficient. Buds are much less hardy in late fall or early spring, so regions where temperatures regularly dip below 0°F during these times should be avoided.

Some of the best blueberry growing regions are near large bodies of water that moderate temperatures. Temperature moderation can also be achieved by planting on north- or east-facing slopes, delaying flowering, and reducing susceptibility to frost damage. Plants on such slopes are also less vulnerable to desiccating western winds. Blueberries grow best in climates that have warm, sunny summers. Cool, cloudy summers reduce the quality of the fruit and favor the spread of fusicoccum canker. Hot summers can decrease fruit flavor and firmness.

The southern limit of production is determined in a large part by the 600- to 1,000-hour chilling (below 45°F) requirement. However, varieties differ considerably in this requirement, and some newer varieties with a lower chilling requirement can be grown throughout the southern states. Stem blight, caused by *Botryosphaeria dothidea*, and stem canker, caused by *B. corticis*, also limit production in warmer regions (see chapter 9, pages 91–93).

In North America, standard highbush blueberry production is generally not successful north of a line connecting the following cities: Muskegon, Michigan; Saginaw, Michigan; Toronto, Ontario; Oswego, New York; Rutland, Vermont; Portland, Maine; and Halifax, Nova Scotia. Smaller-statured varieties can be cultivated successfully in more northern areas where snowfall is ample or plants are protected during winter.

**Soil** Blueberries grow best in well-drained, acid, sandy loams with an organic matter content greater than 3.0%. The ideal soil pH is approximately 4.5, although blueberries will tolerate a pH between 3.8 and 5.5 if the organic matter content is high. Growing blueberries in a less acid soil will result in nutrient deficiencies, especially iron. Blueberry plants and their associated endomycorrhizal fungi can extract phosphorus and potassium from the soil

efficiently, which allows them to grow in nutrient-poor soils. In fact, the better blueberry soils were once considered poor agricultural soils. If wild blueberries or other ericaceous plants are growing on the site, the soil will probably support cultivated blueberries.

Growers can reduce the soil pH if it is slightly above the desired level; however, lowering the pH of some soils can release high levels of certain elements that can be toxic to the blueberry plant. In soils with a high manganese or aluminum content, the soil pH should be maintained near 5.2 to prevent toxicity. These soils are more common in the south central United States.

Sandy soils have a low pH because they tend to have little capacity to retain base cations (calcium, potassium, magnesium) which increase the alkalinity of the soil. Modifying a soil with a low cation exchange capacity is relatively easy, but this becomes difficult as the exchange capacity increases. In clayey soils with a high exchange capacity, permanent pH reduction may be impractical. In addition, clayey soils tend to have poor internal drainage, which makes them even less desirable for blueberries. Soils with a clay or silt content of greater than 20% are not favorable for blueberry production.

As a general rule, modification of soil with 20% or more of its exchange capacity saturated with calcium or with more than 2,000 pounds of calcium per acre is impractical. Modifying such soils is expensive and does not last; the underlying soil tends to buffer the treatment and return the pH to its previous level.

Muck soils with an organic matter content of 20 to 50% are suitable for blueberry production, provided they have an acceptable pH and can be drained. Problems with muck soils include excessive settling and weathering, slow warming in spring, excessive nitrogen release in autumn, and low levels of zinc, copper, and iron. Avoid muck soils with a water table less than 8 inches from the ground surface.

### **Soil Drainage**

The blueberry plant has a shallow root system that is susceptible to drought, yet the roots cannot tolerate standing water. Good soil drainage is an essential factor for successful production. Ideally, the water table should be 15 to 40 inches below the surface even after dry periods. After heavy rain, the water table should recede to at least 8 inches within 24 hours. Standing water during the spring and summer reduces the amount of oxygen in the soil and kills the growing points of the roots (photo 25). Standing water in the winter causes plant heaving, which further damages the root system.

The top 8 to 16 inches of soil should consist of a sandy loam with high organic matter (3 to 20%) overlaid with sand. Plant on raised beds if good internal drainage does not exist (photo 26). Beds should be at least 8 inches high and 48 inches wide.

### **Irrigation**

Most natural blueberry soils have a low water-holding capacity because of their high sand content. Supplemental irrigation is nearly always essential for successful production, especially when planting on raised beds. A source of unchlorinated water with a low salt content (below 0.1%) and low pH (below 6.0) is most desirable. Irrigation water may have to be acidified to prevent nutrient imbalances in the planting. Up to 5 gallons per bush per day may be required when evaporative demand is high (see chapter 12).

**Air Drainage** Air drainage is the movement of heavier, colder air to lower elevations. If the site is in the northern growing region, then slopes with good air drainage will help prevent winter injury. Windbreaks are beneficial in blueberry plantings, but they should be designed to minimize interference with air drainage.

When blueberries are in full bloom, the flowers can be injured by temperatures slightly below freezing (30°F). The exact temperature that damages flowers depends on the rate of temperature change, wind speed, humidity, sugar content of nectar, flower orientation, etc. Under certain conditions, open blueberry flowers can tolerate temperatures as low as 23°F. The earliest-flowering varieties are most susceptible to frost injury, so avoid planting these in frost pockets.

**Location to Markets** The location of the planting determines to a great extent the type of marketing that can be considered. Most natural blueberry soils are not near major metropolitan areas, so prepicked fruit for fresh market and mechanically harvested fruit for processing are the major options. Closer to cities, pick-your-own (PYO) operations should be considered. The trade area for PYO blueberries seems to be larger than the 20-mile radius documented for strawberries. If the planting will be harvested by the public, then site plans must include a parking area and restroom facilities.

**Site Preparation** Assuming the site has potential to grow blueberries, the first step is to determine if soil modifications are necessary. At least one year before planting, collect an adequate number of soil samples to be representative of the proposed site. Multiple samples from uniform sites should be bulked and mixed to obtain a single sample. In nonuniform sites, soil should be sampled separately for each distinctly different area. Soil pH or nutrient levels can vary greatly over short distances, so 5 or 6 samples for a 10-acre site is reasonable. In uniform sites, submit at least one sample for every 10 acres. Since blueberries root to depths of 12 to 16 inches, collect both a topsoil (to 8 inches) and subsoil (8 to 16 inches) sample for analysis. Shallow samples can give misleading results; nutrient content of soils can differ greatly between the two depths.

The Cooperative Extension System in most states offers a soil testing service. Samples can also be analyzed by private laboratories. If the soil test results indicate that blueberry production is feasible (see appendix 1), then clear the site and eliminate perennial weeds. A systemic postemergent herbicide is the most efficient weed remover. These herbicides are most effective when applied in late summer because all the perennial weeds have emerged by then, and translocation of the herbicide is toward the root system.

Some leveling may be necessary to eliminate low areas in the field, but avoid disturbing the subsoil during land preparation. Artificial drainage may be required on poorly drained soils, and it should be capable of removing excess water within 24 hours. Contrary to public opinion, blueberries do not grow well in swamps. In swampy areas, they grow on raised hummocks above the water level, or on the banks near the water. Before draining wet areas in a field, consult the Soil Conservation Service for an update of the current state and federal definitions of a wetland and the regulations regarding modification. Farmers who have modified wetland habitats without permission have had to pay substantial penalties.



Once the field is cleared and drainage problems are addressed, examine the results from the soil test and obtain the required amounts of sulfur, lime, magnesium, potassium or phosphorus. Spread the material evenly over the entire area to be planted, and incorporate to a depth of 8 to 12 inches. If possible, treat the entire field, not just the strips into which the plants will be set; it is more difficult to maintain a low pH if only strips are treated, and if roots spread into the aisles and encounter high-pH soils, the plants will be less productive. Soil modification after planting is much more difficult than modification before planting.

Sulfur can be used to lower the soil pH to 4.5, and the amount required is dependent on soil type (table 4). Relatively little sulfur will be needed on sands, but loams and mucks may require so much that modification may not

be economically feasible. The success of sulfur addition will depend on the soil's cation exchange capacity (see appendix 1).

**Table 4.** Approximate amount of sulfur (pounds per acre) required to lower soil pH to 4.5.

Current pH	SOIL TYPE		
	Sand	Loam	Clay
5.0	175	530	800
5.5	350	1050	1600
6.0	530	1540	2310
6.5	660	2020	3030
7.0	840	2550	3830

Approximately one year is required for sulfur in the soil to oxidize and reduce the soil pH. Powdered sulfur acts more quickly than prills, but is also more expensive and unpleasant to spread. Oxidized sulfur is available in the form of aluminum sulfate or iron (ferrous) sulfate, but these materials are required in much larger amounts (6-fold and 8-fold, respectively) than elemental sulfur, and they can be toxic to the blueberry plant in some soils.

Lime may be needed if the soil pH is below 4.0. If magnesium is also low, then dolomitic lime may be used to increase the pH and magnesium levels simultaneously. If lime rates are not given and the pH is below 4.0, then estimated lime rates are 1,000 pounds per acre on sandy soils, 2,000 pounds on loamy soils, and 4,000 pounds on muck soils.

Specific fertilizer recommendations based on nutrient levels are difficult to make because laboratory extraction procedures vary and results are reported in different units. Contact your local Cooperative Extension System for assistance in interpreting results.

**Fumigation**

If the potential site contains nematodes or if soil pathogens or harmful insects are known to be present, fumigation may be beneficial (see chapters 8–9).

**Cover Crops**

After incorporating nutrients, use a cover crop to increase the soil organic-matter content and suppress weed seed germination. The cover crop can be incorporated in fall or the following spring before planting. In many upland mineral soils, increasing the organic matter content is essential for successful production. In addition to the cover crop, incorporation of leaf litter, compost, or peat can be beneficial.

Cover crops take considerable amounts of nitrogen from the soil. Add 40 to 50 pounds of nitrogen per acre for cover crop establishment. This nitrogen will be released slowly into the soil during the following year when the cover crop

decomposes. To increase the amount of nitrogen available to newly planted blueberries, incorporate the cover crop the fall before planting. If soil erosion is possible, then retain the cover crop until spring. Legumes do not require supplemental nitrogen, but they establish poorly on acid soils. They are not recommended as blueberry preplant cover crops.

Buckwheat is tolerant of low soil pH and inhibits weed seed germination, but contributes little organic matter from the roots. Buckwheat must not be allowed to mature, or it will reseed. A rate of 60 pounds per acre is recommended for seeding in late spring or early summer.

Spring oat is also a good cover crop because of its tolerance to low-pH soils. Plant in early to mid-April in the north, and incorporate before the end of June. Another option is to seed in mid-August and overwinter the crop. Oats will be gradually killed by successive frosts and will not grow again in spring. One hundred pounds of oat seed are required per acre.

If raised beds will be used, they should be made just before planting, after the soil has been modified. Drip irrigation is required when growing on raised beds to prevent rapid drying under droughty conditions.

**For More Information** Brady, N.C. *The Nature and Property of Soils*. New York: Macmillan Company, 1990.

## Chapter 4

# PLANT SELECTION AND PROPAGATION

---

The most critical factor in establishing a blueberry planting is to obtain high-quality plant material. The material should be well-rooted and free of pathogens such as viruses and root diseases. Purchase only inspected plants which have a state certificate of inspection. Propagation from an existing planting is an option if the stock is known to be free of viruses. Test kits are now available for virus detection, and some nurseries offer virus-indexed plants.

Several characteristics should be considered when a variety is selected: season of ripening, yield, fruit quality, hardiness, chilling requirement, growth habit, vigor, disease resistance, local adaptation, and intended market (table 5).

The fruit on each variety ripens over 2 to 5 weeks. Varieties with successive ripening periods extend the harvest season. The potential harvest season in North America ranges from 4 to 5 months.

Fruit for mechanical harvest should have small, dry scars so detachment is easy, and bushes should have an upright growth habit. Fruit for the fresh market should have good flavor, a light blue color, and skin that does not tear when the berry is picked.

Three major types of highbush blueberries are southern (with low-chilling southern species in the parentage); northern (essentially of *V. corymbosum* origin, with some contributions from *V. angustifolium*); and half-highs (hybrids of highbush and lowbush blueberries). Southern highbush types require less than 600 hours of chilling (below 45°F) and cannot tolerate temperatures much below -5°F. Northern highbush types require a minimum of 750-1,000 hours of chilling and can survive fairly cold winter temperatures (-20°F). Half-high types require 800-1,000 hours of chilling and can survive extreme cold (-35°F) if they are buried in the snow.

## ***Blueberry Varieties***

---

The most widely planted varieties and the most recent releases are described in this chapter. Before planting, find out from other growers in your climatic zone which varieties grow well. The performance of the most commonly planted varieties can be predicted for most regions, but small test blocks of new releases should be established before planting on a large scale. Disease resistance is critical in some regions such as eastern North Carolina and central Florida where stem canker can severely limit productivity. Additionally, some varieties lend themselves to mechanical harvesting because of their particular growth habit and the easy abscission of the fruit. Contact your local Cooperative Extension System for advice on blueberry varieties for your area.

**Table 5. Important characteristics of selected highbush varieties.<sup>1</sup>**

	Fruiting Season	Yield Potential	Fruit Size	Scar	Firmness	Flavor	Winter Hardiness
<b>Southern Highbush</b>							
Avonblue	2	3	3	3	3	3	1
Blueridge	2	2	2	1	3	3	1
Cape Fear	2	3	3	3	3	2	1
Cooper	2	2	2	2	3	2	1
Flordablue	1	2	4	2	2	3	1
Georgiagem <sup>2</sup>	2	2	2	3	3	2	1
Gulf Coast	1	2	2	4	3	2	1
O'Neal <sup>2</sup>	1	2	2	3	4	3	1
Reveille <sup>2</sup>	1	2	2	2	4	2	2
Sharpblue	1	2	3	2	2	2	1
<b>Northern Highbush</b>							
Angola	1	1	1	1	1	3	2
Berkeley <sup>2</sup>	3	2	3	1	3	2	3
Bluechip	2	3	4	3	4	3	2
Bluecrop <sup>2</sup>	3	3	4	4	4	3	4
Bluegold	4	3	2	3	3	3	4
Bluehaven	2	2	3	3	3	3	2
Bluejay <sup>2</sup>	2	2	3	4	4	3	4
Blueray	2	3	4	2	3	3	4
Bluetta <sup>2</sup>	1	2	2	1	2	2	3
Bounty	3	3	3	3	3	1	2
Collins <sup>2</sup>	2	2	3	3	3	3	4
Concord	3	2	1	1	2	4	3
Coville <sup>2</sup>	4	2	4	2	3	3	3
Croatan	1	4	2	1	2	2	2
Darrow	3	1	4	3	3	4	3
Dixi	3	3	4	1	2	3	3
Duke <sup>2</sup>	1	3	3	3	3	2	4
Earliblue <sup>2</sup>	1	2	3	2	2	1	3
Elizabeth	4	2	3	3	3	4	4
Elliott <sup>2</sup>	4	4	2	3	4	2	4
Harrison	1	3	4	2	3	2	2
Herbert <sup>2</sup>	4	2	4	2	2	4	4
Ivanhoe	3	2	1	2	3	4	3
Jersey <sup>2</sup>	4	3	2	2	3	2	4
Lateblue <sup>2</sup>	4	3	3	3	3	3	4
Meadar	2	2	2	4	3	2	4
Morrow	1	2	2	1	2	2	2
Murphy	2	2	2	1	3	2	2
Nelson	3	3	4	4	3	4	4

<sup>1</sup> Fruiting season (1–4, early to late); Yield potential (1–4, low to high); Size (1–4, small to large); Scar (1–4, large to small); Firmness (1–4, soft to firm); Flavor (1–4, weak to excellent); Winter hardiness (1–4, limited to very hardy).

<sup>2</sup> Variety is suitable for mechanical harvest.

Table 5— continued

	Fruit Season	Yield Potential	Fruit Size	Scar	Firmness	Flavor	Winter Hardiness
Patriot <sup>2</sup>	2	2	3	3	3	3	4
Pemberton	3	3	3	1	2	2	4
Rancocas	2	2	1	2	3	2	4
Rubel <sup>2</sup>	3	2	1	2	3	2	4
Sierra	3	3	3	3	3	2	3
Spartan <sup>2</sup>	2	3	4	2	3	4	4
Stanley	2	2	1	1	3	4	4
Sunrise	1	3	2	3	2	3	4
Toro <sup>2</sup>	3	3	3	4	3	3	4
Weymouth	1	2	2	2	1	1	4
Wolcott	1	2	2	3	2	2	2
<b>Half-highs</b>							
Northblue	3	2	2	2	3	3	4
Northcountry	3	2	2	3	2	2	4
Northland	2	4	2	2	1	2	4
Northsky	3	1	1	2	3	3	4
St. Cloud	3	2	2	4	3	4	4
<sup>1</sup> Fruiting season (1–4, early to late); Yield potential (1–4, low to high); Size (1–4, small to large); Scar (1–4, large to small); Firmness (1–4, soft to firm); Flavor (1–4, weak to excellent); Winter hardiness (1–4, limited to very hardy).							
<sup>2</sup> Variety is suitable for mechanical harvest.							

## Southern Highbush

### Established Varieties

*Avonblue* Plants are spreading, moderately sized, and very productive. Must be pruned lightly every year to prevent overbearing. Fruit is large and of the highest quality of any low-chilling type. Is relatively self-fruitful, but planting with other varieties is recommended. Probably has resistance to stem canker and bud mites. Is an early producer that is adapted to north central Florida.

*Flordablue* A medium-sized bush which has very large early fruit, average firmness, and a moderately wet scar. Does not ship well due to its wet scar and must be cross-pollinated. May be resistant to stem canker. Adapted for central and south central Florida.

*Sharpblue* The most widely grown variety in central and southern Florida. Is very similar to Flordablue, except fruit is darker. Requires cross-pollination. Plant type is spreading and medium tall. Has the lowest chilling requirement of any highbush variety. Probably resistant to stem canker. Early producer.

### New Releases

*Blueridge* Broadly adapted across the Southeast and Arkansas. Is very productive with medium-sized, firm fruit. Has pleasant high-acid flavor with only a fair picking scar. Is resistant to stem canker. Needs 500 to 600 hours of chilling.

- Cape Fear* High-yielding type with large, firm fruit. Has a small scar, but only fair flavor. Is resistant to stem canker, and is very broadly adapted to the South-east. Needs 500 to 600 hours of chilling.
- Cooper* Moderately productive and upright with medium-sized fruit. Flavor, color, and firmness are good. Blooms fairly late and needs 400 to 500 hours of chilling.
- Georgiagem* Consistently producing, high-yielding, semi-upright bush with medium-sized fruit. Berries are firm with a small dry scar. Appears to benefit from cross-pollination. Major limitation is susceptibility to cold spring temperatures. Needs approximately 350 hours of chilling.
- Gulf Coast* Semi-upright plant that has moderate productivity. The fruit is small to medium-sized and firm, with good flavor. The stem scar is very small. Requires 400 to 500 hours of chilling.
- O'Neal* A somewhat branching, semi-upright bush that produces very early yields of moderate-sized fruit. Early bud break can result in cold damage in spring. Has a good scar and flavor and is very firm. Is resistant to stem canker. Needs approximately 500 to 600 hours of chilling.
- Reveille* Consistent producing, upright bush with broad soil adaptations. Has firm, moderate-sized fruit with a good picking scar. Is very resistant to stem canker; moderately resistant to stem blight and mummy berry. Has performed well in observation trials throughout the highbush production region in southeastern North Carolina.

## **Northern Highbush**

### *Established Varieties*

- Angola* A vigorous, upright bush producing a loose fruit cluster with large, dark berries. Very early production. Resistant to canker.
- Berkeley* Berries are light blue, firm, and very large, and store well even though they have a large stem scar. Winter hardiness is limited and flavor is only fair. Bush is moderately tall and spreading.
- Bluechip* Provides excellent-flavored, firm fruit. Can be highly productive, but is difficult to establish. Has field tolerance to stem canker although it is not resistant. Is vigorous and upright growing; easy to prune.
- Bluecrop* Is the most widely grown variety in the world. Produces numerous medium-sized, firm berries. Tends to overproduce if not pruned regularly. Its scar is small and its flavor good. Is field resistant to shoestring and red ringspot virus, and is moderately resistant to mummy berry and powdery mildew.
- Bluehaven* Upright and productive, but not sufficiently hardy for northern areas. Berry is large, light blue, and exceptionally flavorful. The scar is small and dry.
- Bluejay* Upright, open, rapidly growing bush that produces moderate yields of medium-sized, firm fruit that ships well. Has small stem scar and mild, slightly tart fruit. Is field resistant to shoestring virus and is moderately resistant to mummy berry.

- Blueray* Fruit is large, dark blue, and firm with good flavor. Consistently productive but may overproduce if not pruned regularly. Has an upright-spreading habit and is very hardy. Heavily bearing canes tend to flop.
- Bluetta* Produces moderate yields of medium-sized fruit. Flavor and firmness is only fair and its stem scar is broad. Has blue-black fruit that is unattractive in the fresh pack. Bush is small, low growing and spreading. Very susceptible to *Botryosphaeria* canker in southern climates.
- Bounty* Consistent producer of large fruit with good flavor. Fruit has a small scar and is firm. Intended for the fresh market in areas subject to stem canker and stem blight. Is moderately vigorous with a spreading growth habit. Probably not well adapted to upland soils.
- Collins* Has upright habit with some spreading canes. Fruit is large and firm with good flavor and small scar. Has rather narrow soil adaptation and produces only moderately.
- Concord* One of the best-flavored varieties, but not widely grown commercially due to small fruit size, dark color, and tendency of scar to tear. Fruit ripens in midseason on a moderately vigorous bush. Excellent for home gardens.
- Coville* Is a moderately upright bush with somewhat erratic yields due to limited hardiness. Has a very large, firm fruit with a medium scar and a good, tart flavor. Excellent processing quality.
- Croatan* Most widely planted variety in North Carolina. Is a very productive, erect bush with only medium fruit quality. Fruit is fairly soft with a mild flavor and ripens very quickly in hot weather. Is resistant to stem canker.
- Darrow* An upright bush producing very large, late, flavorful fruit when fully mature. Recommended for home garden use in warmer areas.
- Dixi* A vigorous, spreading, productive bush with highly aromatic fruit. The late-season fruit is very large but tends to crack and has a poor scar. Suitable for home gardens.
- Earliblue* A very early variety that produces large, firm fruit with only fair flavor. The bush is vigorous, upright, and hardy. Fruit does not drop easily when ripe, and ships well. Plants have some resistance to powdery mildew.
- Elizabeth* One of the best-flavored blueberry varieties, it produces light-blue fruit late into the season. Fruit size varies across production regions, and yields are generally low to moderate. Recommended for home gardens.
- Elliott* Plants are very productive, but fruit may ripen too late for many northern areas. Considered the latest of all varieties. Also, berry is not fully ripe when it first turns blue. Fruit is small and has only a mild flavor, but is very firm and stores well. Plant is upright and somewhat bushy. It is widely planted.
- Harrison* A southern variety with larger fruit than Croatan but less productive. Relatively firm with a small stem scar and good flavor but does not ship well. Has a semi-upright, vigorous habit. Is resistant to stem canker and tolerant to bud mite, but very susceptible to *Phytophthora* root rot.

- Herbert* Productive, late-season variety that produces very large fruit of excellent quality. Plant is hardy, large, and spreading. Skin is rather tender. Excellent PYO variety. Moderately resistant to mummy berry.
- Ivanhoe* Perhaps the best flavored of the early varieties, it performs well in southern states. Plants are vigorous and fruit is small. Excellent for home gardens.
- Jersey* Has medium-sized berries with firm flesh and fair flavor. Provides consistent yields across a broad range of conditions, provided that pollination is adequate. Plants are tall and upright, and adapted to mechanical harvesting.
- Lateblue* The bush is erect, vigorous and very productive. May ripen too late for northern areas. Flavor and scar are good.
- Meador* Produces large, firm fruit with a dry scar and good flavor. The bush is erect, vigorous, and very hardy. Grows well in cold areas with short growing seasons.
- Murphy* A low-spreading bush that produces firm fruit with a large scar but good flavor. Is a good, consistent yielder that is resistant to stem canker.
- Patriot* Fruit is large and firm with a small scar. Fruit must be completely ripe to have good flavor and sweetness. Bush is small to medium in height and grows slowly. Is hardy during winter, but blooms early and is subject to frost. More tolerant of heavier soils. Has some resistance to phytophthora root rot. Recommended for northern areas.
- Pemberton* One of the most vigorous and productive bushes, producing dark blue, firm fruit. Major disadvantage is the poor scar.
- Rancocas* A smaller bush producing small, firm, flavorful fruit. Major disadvantage is cracking after a rain.
- Rubel* A wild selection with small, firm fruit. Flavor is fair and yields are moderate.
- Spartan* Fruit is firm, very large and highly flavored. Has high, early yields on ideal blueberry sites even though it blooms late, but does poorly on amended upland soils. Upright, open bush that harvests well mechanically. Some resistance to mummy berry.
- Stanley* An older variety that produces early. Its fruit is small, with an excellent flavor but a poor scar. Suitable for use in the home garden in warmer areas.
- Weymouth* Produces moderate yields of soft, dark-blue, weakly flavored fruit on a low growing plant. Grown mostly for its earliness in New Jersey and Washington.
- Wolcott* A very vigorous, upright, productive bush with large, round, dark blue fruit borne in loose clusters. Season is early and short. Resistant to canker.

### *New Releases*

- Bluegold* Berries are medium in size with small, dry scars, good flavor and firmness. Is a low-growing plant with many branches.
- Blue Rose* Is an upright Australian variety with large, slightly acid fruit and a good scar. Has not been tested in North America.



- Brigitta Blue* Upright Australian variety that has very firm, sweet fruit and a small scar. Shows promise as a good shipper and is probably suitable for mechanical harvesting. Is an open-pollinated selection of Lateblue that has not been tested in North America.
- Caroline Blue* Australian variety that has large fruit with excellent flavor and a good stem scar. Has concentrated ripening and moderate vigor. Is an open-pollinated selection of Lateblue that has not been tested in North America.
- Denise Blue* Produces very large fruit with some red at the stem end. Is a moderately vigorous, somewhat spreading bush. Fruit has a very good scar and excellent flavor. Is an open-pollinated selection of Bluehaven from Australia, but has not been tested in North America.
- Duke* Is an early-ripening type with a late blooming date. Bush is upright and open. Fruit is medium-sized and firm with weak flavor, suitable for mechanical harvesting because of uniformity of ripening.
- Nelson* Is a very productive, upright, fine flavored variety. Provides large, firm berries with small, dry scars.
- Nui* Selected in New Zealand and untested in North America. Is a moderate producer with extremely large fruit.
- Puru* Selected in New Zealand and untested in North America. Produces moderate yields of large, dark fruit.
- Reka* Selected in New Zealand and untested in North America. Has very high yields of moderately sized, dark fruit.
- Sierra* Fruit is medium sized and firm with good flavor and a small scar. Is a medium-sized bush that is generally productive.
- Sunrise* Ripens with Bluetta but is taller and more upright in plant characteristics, and its fruit quality is superior to that of Bluetta. Is heavy producing with a late bloom date and somewhat concentrated ripening.
- Toro* Develops an upright and open bush that ripens with Bluecrop. Fruit is medium in size and firm, with a good flavor and small dry scar.

### **Half-High**

#### **Established Variety**

- Northland* Is an extremely productive half-high type with medium-sized, soft fruit. Can get as tall as 4 feet but its canes are flexible and are often weighted down by snow. It generates high numbers of canes each year, making heavy annual pruning necessary.

#### **New Releases**

- Northblue* Is a low-statured (2 to 4 feet), vigorous variety with low to moderate yields. Fruit is medium-sized, dark blue, and firm, with a good flavor. Leaves become an attractive dark red in fall.
- Northcountry* Bush is 3 feet tall with moderate vigor. Has medium-sized fruit that is sweet and mild.

*Northsky* Bush is less than three feet tall with dense branching. Fruit is sky blue and small to medium in size, and stores well. Foliage turns an attractive dark red in the fall.

*St. Cloud* Is the tallest of the half-high types at 4 feet and has moderate yields. Fruit is medium blue, medium-sized, and well flavored with a small, dry scar. Is firm and stores well.

## **Blueberry Propagation**

---

Propagation may not be economical for growers with less than 5 acres. Larger growers often find that propagating their own plants saves money and fits well into the overall farm operation.

Identifying a source of true-to-name, nondiseased plant material is essential for successful propagation. Many virus diseases can be dormant in field-planted material for several years, so great care should be taken to use only disease-free, vigorous plants. Do not propagate from plants adjacent to bushes showing disease symptoms. If possible, have the plants screened by a state inspector or a trained plant pathologist, or use a virus test kit (see chapter 9).

Highbush blueberries can be propagated by both hardwood and softwood cuttings. Most propagation is done with hardwood cuttings, but some nurseries in the southern United States use softwood cuttings. Hardwood cuttings (photo 27), taken from dormant shoots, are easier to handle and less perishable, but softwood cuttings, taken from actively growing shoots, allow more rapid multiplication of plants.

In the last few years, a few laboratories have begun to propagate blueberries by tissue culture. This procedure allows for rapid proliferation of certain varieties, but also requires an expensive, specialized laboratory. The growing tips of plants are removed under sterile conditions and placed into a special growth medium in growth chambers. The resulting plantlets are carefully rooted under high humidity in a greenhouse and are generally sold in transplant trays. Because this technique requires very specialized conditions, this chapter will concentrate on hardwood and softwood cuttings.

### **Hardwood Cuttings**

Blueberries are propagated using shoots (“whips”) of the previous season’s growth that are 12 to 30 inches long. These should be taken from the field after the plants have had a rest period of 6 to 8 weeks at temperatures below 45°F. Whips are usually obtained in spring just before bud growth begins, but if cold storage is available, they can be gathered in the winter and stored at 30 to 40°F in boxes or plastic bags lined with moist sphagnum moss.

### **Making and Storing Cuttings**

Taking cuttings from producing fields is an adequate procedure, but it does reduce fruit production. Another option is a “mother block system,” in which plants are spaced 12 inches apart both within and between rows. The plants should be allowed to grow for 3 years, and then all new growth can be removed for propagation each subsequent year. Diseases are more effectively controlled in this system, but higher rates of nitrogen may be needed.

Proper selection of shoots is important for successful rooting. Do not use plants with observable disease, nutrient-deficiency, or injury symptoms. Take firm, well-matured cuttings from the past season's growth. Do not use shoots formed late in the season; they may be poorly hardened, with shriveled tips and off-white to brown, pithy interiors. Avoid shoots with many branches or with flower buds. Make cuttings of branches  $\frac{1}{4}$  inch in diameter; narrower cuttings root more easily, but the resulting plants need more time to establish themselves.

Each cutting should be about 4 inches long and contain 3 or 4 buds. Cuttings can be shorter when propagation wood is scarce, but they need extra care during storage and rooting to ensure success. Short cuttings have lower food reserves and are less tolerant to extremes in temperature, moisture, and light intensity.

When making cuttings, avoid bruising or crushing the tissue. Use a band saw, sharp knife, or pruning shears with a thinned, sharpened blade and a wooden bumper on the other jaw. Make cuttings in a draft-free area and place them immediately into moist sphagnum to avoid desiccation.

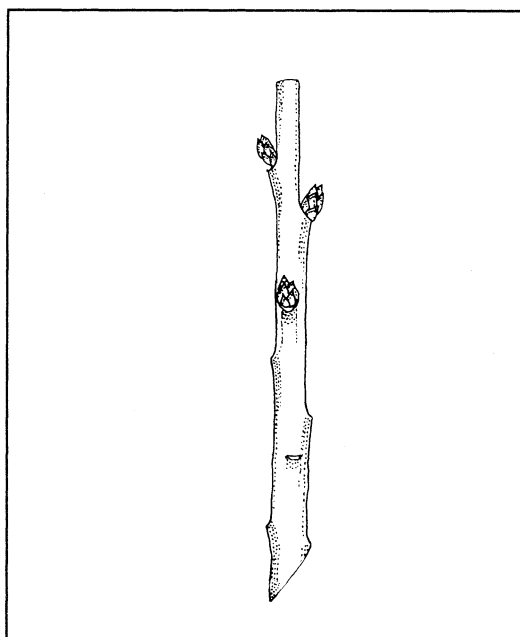

**Figure 5.** *Hardwood cutting.*

Cuttings are less likely to root when they are made close to terminal flower buds. They seem to root best when the distal (top) cut is made directly above the highest bud and a slant cut is made just below the lowest bud. Making cuttings this way is time-consuming, and impractical on a large scale. Using a band saw to cut several whips at a time affects the rooting rate very little (figure 5).

To make planting easier, group cuttings into bunches of 50 with all of their butt ends pointing in the same direction. If the cuttings are to be planted within a week to 10 days, store them upright in trays at 35 to 40°F in a ventilated area with moist sphagnum around the base of the bundles. Cuttings for later planting should be stored without sphagnum in polyethylene bags with all the air squeezed out. It is best not to keep them longer than 3 weeks. They can be dipped in a weak fungicide solution before storage to lower the chances of mold and blackening.

Certain varieties root more easily than others. Bluetta, Patriot, Northland, Blueray, Berkeley, Coville, and Jersey are relatively easy to root, whereas Spartan, Bluejay, Ivanhoe, Bluecrop, and Darrow are more difficult.

#### *Propagation Structures*

Cuttings are rooted in frames placed in greenhouses, screenhouses, or propagation boxes (photos 28–31). A common frame size is 6 by 3 feet and 4 to 10 inches high. (Dimensions vary, depending on personal preference and materials on hand.) Bottoms can be added to the frames by stapling or nailing  $\frac{1}{8}$  to  $\frac{1}{4}$ -inch mesh hardware cloth to their undersides. In recent years, growers have also been propagating cuttings in plastic harvesting lugs. These are easier to carry because they are smaller (16 by 24 inches), and they are readily available where harvesting equipment is sold.

Propagation boxes are often used for rooting small numbers of cuttings. In this method, frames with bottoms are suspended inside wood or concrete forms such that the frames are 4 to 6 inches above the ground. This insulates the cuttings from bottom cold, improves drainage, minimizes disease, and allows for easy removal of groups of cuttings once they are rooted. The frames can also be placed directly on 6 to 8 inches of gravel. This keeps the cuttings above ground level, and by April they are free of frost and warmed at night as the gravel loses its accumulated heat.

Cover the propagation boxes with panes of glass or plastic covered by shading materials—7½ ounce burlap or any other material providing 60% transmittance of light is acceptable. If propagation boxes are used in conjunction with a mist system, then shading may not be necessary. Set boxes in the open sunlight in a location with good water drainage and where frequent inspections can be made.

Use greenhouses for large-scale propagation. Lugs or frames with bottoms can be set on a layer of gravel on the greenhouse floor, or frames without bottoms can be set directly on the ground and filled with 4 to 5 inches of aged sawdust. As with propagation boxes, light should be kept low in the greenhouse unless misting is used. Raised open beds are frequently used in New Jersey.

*Rooting Medium* Generally, pure ground peat is used in Michigan for propagation; a 1-to-1 mixture of peat and sand is used in New Jersey and Arkansas. Mixtures of peat, sand, and perlite can also be used, but some varieties, like Bluecrop, root best in pure peat. The rooting medium should be soaked for 3 to 4 hours before planting to ensure uniform moisture distribution. The medium should be at least 4 inches deep. Do not pack or firm the peat mixture before planting.

*Planting the Cuttings* Planting is usually begun when the threat of severe freezing is over. Push cuttings vertically into the medium until only their top buds are exposed, and set them 2 inches apart in each direction. Do not allow the butts of cuttings to rest on the bottom of frames; if the frames are shallow, place the cuttings on a slant in the rooting medium, leaving one-third of the wood exposed.

Buds swell and shoots form 1 to 2 weeks after planting. The cuttings will not grow after this initial surge until they begin to root; this occurs in 3 to 4 months, about the same time that the tip buds begin to green.

*Irrigation* In relatively airtight outdoor propagation boxes, the glass sash should be propped up ¼ inch until rooting takes place. Examine the propagation medium each day; moisture is adequate when water can be squeezed out of the medium with moderate pressure between the thumb and forefinger. When water is needed, sprinkle it over the cuttings in the morning before the heat of the day.

In a greenhouse, cuttings are irrigated with an intermittent mist. Water should be misted over the plants for 6 to 8 seconds in 3- to 5-minute intervals, using the lower rates on cooler, cloudy days. Run the system from 10 a.m. to 5 p.m. each day until the plants root, and then from 11 a.m. to 4 p.m. after rooting. The plants can also be sprinkle-irrigated after they have rooted. Check the soil periodically to make sure that it has not become waterlogged; if it has, decrease the amount of water applied.

*Sanitation* Loss from fungal infections can be severe if continuous sanitation procedures are not practiced. When checking propagation frames for moisture, all the leaf litter that has fallen onto the soil and any cuttings that show signs of disease should be removed.

Several steps can be taken if fungal infections become established. Increase ventilation in sash systems, and reduce flow rates in intermittent mist systems (as long as wilting does not occur). Apply fungicides at weekly intervals, using soil drenches. Fungicides can injure plants if conditions become hot and humid, so apply these materials early in the morning, and rinse the leaves of cuttings with clean water to reduce harmful residues.

*Fertilization* Serious injury or death of the cuttings can occur when fertilizers of any kind are mixed into the rooting medium. Do not start fertilization until the cuttings are well rooted.

Ammonium sulfate is commonly used for fertilization, although any fertilizer containing nitrogen in the ammonium form can be applied. At 1 ounce of ammonium sulfate per gallon of water, one gallon is sufficient for a 6 x 3 foot propagation frame, and should be added only once or twice a year. No fertilizer should be applied after mid-August to ensure that the plants properly harden off in the fall. As with the fungicide drenches, wash the leaves with clean water after fertilization to avoid leaf injury.

*Winter Storage* Cuttings need to be exposed gradually to the natural environment after they have rooted in propagation boxes. The sash should be raised slightly each day for 1 to 2 weeks until the cover is totally removed. The shading material should be left on until September to avoid burning and scorching of the leaves, but it must be removed sometime in September to facilitate hardening off. Greenhouse temperatures should also be allowed to drop gradually. This can be accomplished in permanent houses by opening vents and in polyethylene houses by removing the plastic as it begins to deteriorate in August.

Rooted cuttings can be overwintered in the propagation boxes and greenhouses, or they can be placed in cold storage after they have hardened off. Bare-rooted cuttings should be stored at 32 to 40°F in plastic bags or in boxes lined with sphagnum moss. When the plants are left in the boxes or greenhouses, they must not be allowed to dry out. Bank the soil on the sides of propagation boxes to prevent bottom ventilation and excessive freezing.

*Planting and Care in the Nursery* Rooted cuttings are generally planted in the nursery in mid-April, or just before bud break. They should be set in rows at least 18 inches apart, depending on the method of cultivation and individual equipment sizes. Within-row spacings should be 6 to 10 inches.

The cuttings should be side dressed with fertilizer 2 to 3 weeks after planting. A 1:1:1 or 2:1:1 ratio fertilizer is generally used at a rate of about 1 to 1.5 ounces actual nitrogen per 100 square feet. A second application may be made in July if needed. The fertilizer must not be applied when the leaves are wet or they can be burned.

Clean cultivation is suggested in young beds, with a cover crop of oats planted between rows in early fall. Irrigation is required during drought periods since young blueberry plants are very sensitive to moisture deficits.

Plants are usually sold after one full year in the nursery bed (photo 32). In climates with longer growing seasons, one-year-old bare-rooted plants are sold and transplanted successfully in the fall. Such plants should be at least 18 inches tall.

## Softwood Cuttings

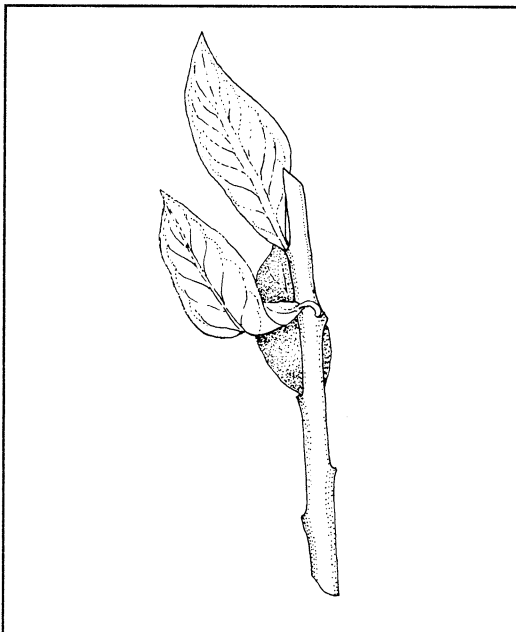

**Figure 6.** *Softwood cutting.*

Softwood cuttings should be taken during the growing season before flower buds form. Actively growing shoots 6 to 8 inches long are used; longer shoots can be used, but their bases are too old to root well. The upper, soft portion of the lateral should be removed so that a 5-inch cutting remains (figure 6). Two or three basal leaves should be stripped off, and the cutting should be inserted upright into the propagation medium to about half its length. Propagation frames and rooting media used for hardwood cuttings are also used for softwood cuttings, but ventilation is more critical; airflow should be great enough to keep water from condensing on plants, but not so great as to cause wilting. Shading is also critical; serious problems can occur on partly cloudy days when the sun suddenly emerges and rapidly heats up the plants. If this happens, increase ventilation and shading. Once rooting occurs, follow the same procedures as for hardwood cuttings.

## Other Methods

Blueberry plants can be propagated by shoot tip culture in agar. This method is useful for producing disease-free stock, but is expensive relative to other methods. A few nurseries currently produce blueberries through shoot tip culture (photo 33).

Budding and grafting techniques can be applied to blueberries, but the long-term need for regeneration of canes makes these methods impractical on a commercial scale.

Blueberries can be propagated from seed, but they do not breed true to type. Breeders are the principal users of blueberry seeds. Seeds have a light requirement and germinate several weeks after cold stratification in moist sphagnum moss.

## Chapter 5

# ESTABLISHING THE BLUEBERRY PLANTING

---

Blueberry plants should be set only in fields that were adequately prepared for planting the previous year. If the row middles are to be planted to a sod cover, seeding should occur in late summer or early fall of the year before planting. Grass seed germinates best in the fall, and the grass will be established when the plants are set the following spring. Seeding can also be done in spring of the planting year.

Blueberry planting is done in early spring as soon as the soil can be worked, usually April through mid-May. Fall planting can be done in warmer climates where the risks of winter injury and frost heaving are less severe. Blueberry plants should be ordered from a reputable, high-quality nursery (preferably certified virus-indexed stock) well in advance of planting (1 or 2 years is best) to ensure availability of the desired varieties and plant sizes. The climatic limitations of the site and the intended market need to be considered in the variety selection process (see page 14 and chapter 4).

Nursery plants are available in a range of ages and as either bare root or container grown. In general, vigorous 2- to 3-year-old plants are preferred over rooted cuttings as they will mature and produce in a shorter time from planting. Container-grown stock may have some benefit over bare root stock, particularly if planting is delayed past early spring, as they tolerate transplanting well. One disadvantage of container plants is that roots may become bound in the pot; some root pruning may be required. Another is that container plants are much more expensive to ship, although the increased cost of larger stock may be offset by the reduced time to first production. Blueberry plants should be shipped from the nursery by late February in the South and by mid-April in the North to limit the risk of exposure to high temperatures during transit. Container stock can be maintained outdoors until planting as long as it is watered, while bare root stock should be kept under refrigeration. Micropropagated plants are also available; these require special attention to soil moisture and content to ensure good establishment.

**Field Layout** The blueberry planting needs to be planned to use land efficiently; accommodate equipment for pest control, mowing, and harvest; and provide for the cross-pollination needs of the varieties selected. Plant densities of 870 (5' x 10') to 1,089 (4' x 10') plants per acre are common in commercial plantings. Spacing rows 10 feet apart provides access for mowing, pest control, pruning, and harvest equipment. Uniform plant spacing is important. Spacing plants less than 5 feet apart within the row can cause heavy production in the early life of the planting, but plants may become crowded as the planting matures, which increases management costs. If the planting will be harvested PYO, then rows should be no longer than 200 feet so customers do not have to carry fruit long distances.

The cross-pollination needs of the blueberry are best met by planting 2 or more varieties having similar bloom periods in a field in alternating pairs of

rows. Many growers do obtain satisfactory yields from large blocks of the same variety. North-south rows are generally best for optimal light exposure. If the land is sloped, air drainage and equipment considerations may override the advantage of a north-south orientation. Ridging is essential in many areas, and often irrigation is required to maintain adequate soil moisture (see chapter 12).

**Planting** Blueberry plants should be set in early spring when severe freeze danger has passed (photo 34). Remember that the blueberry root system forms a shallow, dense mat and the planting hole needs to be more wide than deep, at least wide enough to accommodate the spread of the root system of the plants. A pound of wet peat moss should be incorporated in the planting hole soil during backfilling, especially in soils that are coarse-textured or high in silt and clay. The peat needs to be soaking wet—dry peat will not wet easily and may draw soil moisture away from the blueberry roots, stunting or even killing young plants. Saturate the peat bales and allow them to soak for several days before planting. This incorporated peat will improve soil moisture and nutrient holding capacity in the root zone and facilitate root penetration by improving soil texture. Incorporating peat into the entire row is more expensive but even more beneficial.

Set blueberry plants at the depth they were planted in the nursery. Spread the root system and firm backfill soil to maximize root-soil contact. Irrigate the planting with 1 inch of water immediately after planting to enhance the root-soil contact. To reduce the stress on the root system, remove at least a third of the top growth of the newly set plant; this will eliminate some of the transpirational demand. Rub off any flower buds on the newly set plants so all of the growth will be allocated to vegetative structures.

**Managing the New Planting** Weed control is perhaps the most important management practice for new blueberry plantings. The area within 3 feet of the newly set plant should be weed free throughout the summer to limit competition for moisture and nutrients. Any cultivation in the immediate area around blueberry bushes needs to be extremely shallow; the blueberry root system is very close to the soil surface and is easily damaged.

Herbicides may be useful tools in the weed-control program. Preemergence herbicides may be used to control annual weeds before seed germination; postemergence herbicides may be used to control broadleaf weed and grass problems that develop. Consult Cooperative Extension for current recommendations (see chapter 10).

With both southern and northern highbush blueberries, mulching is often considered an essential practice. The application of an organic mulch will help suppress weeds, moderate soil temperatures, enhance soil moisture levels, buffer changes in soil pH, and increase organic matter. Softwood sawdust is the most common mulching material; wood chips, bark, straw, corn stalks and combinations of all these materials are also suitable for mulching blueberries. The mulch layer should be 3 to 5 inches thick, and should be flat topped (rather than coned), if possible, to facilitate moisture penetration. Some wood chips added to the sawdust will improve moisture penetration. A 4-foot-wide mulched strip is better than smaller mulched



areas around individual plants. Decaying mulch provides organic matter to the soil, and this is thought to improve production on mineral soils (photo 35).

Blueberry roots tend to grow in the interface of the mulch and soil. Replenishing the mulch is important so roots are not exposed when the mulch decomposes.

Newly set blueberry plants may be fertilized 3 to 4 weeks after planting, and again in 4 more weeks if the organic matter is less than 3.0%. Apply either a complete fertilizer formulated for use on acid-loving plants or ammonium sulfate (21-0-0). Apply the equivalent of 6 pounds per acre actual nitrogen ( $\frac{1}{2}$  ounce ammonium sulfate per plant) in circles extending 12 inches beyond the crown of each plant. This application may be repeated in early July if growth is unsatisfactory. On low-pH soils (below 4.0) or on organic soils, urea may be substituted for ammonium sulfate at half the above rate.

Since the blueberry is not an efficient extractor of water from the soil, careful attention to the water needs of the plants throughout the summer and fall is essential (see chapter 12).

Generally, insect and disease pressure on young blueberry plants is minimal. Chewing insects such as gypsy moth larvae can be a serious pest in new plantings where populations are peaking. Consult Cooperative Extension for pest management recommendations for your area (see chapters 8 and 9).

## Chapter 6

# MAINTENANCE OF THE ESTABLISHED PLANTING

---

Once blueberries are established, major horticultural considerations are nutrition (chapter 11), water management (chapter 12), pest control (chapters 7, 8, 9, 10, and 13), and harvest (chapter 14). This chapter will address the remaining considerations of pruning, mulching, and pollination.

## Pruning

---

Pruning is required to maintain the vigor and productivity of bushes, and to develop an appropriate growth habit for harvesting. Pruning reduces fruit numbers and permits sunlight to reach further into the canopy, thereby improving the sweetness and size of fruit.

The increased air circulation that results from pruning reduces conditions favorable for disease development. Pruning also is used to remove diseased plant parts. Proper pruning will allow for elimination of older, less productive canes and rejuvenation of new cane growth, which is essential for stable production.

Early spring is the best time to prune blueberries. Winter-injured wood is most easily identified in spring; carbohydrates produced in autumn have had enough time to move into the roots and crown for storage. Some growers do prune immediately after harvest, but this tends to reduce long-term productivity and make the bushes more susceptible to winter injury.

Weak bushes require more pruning than vigorous bushes because pruning stimulates vegetative growth. Varieties with spreading habits need special consideration: sprawling canes should be removed, but care should be taken to leave enough canes for fruiting. Weymouth and Bluetta have a weak growth habit, and require detailed pruning to maintain vigor and fruit size. Earliblue, Collins, Blueray, Herbert, and Coville have an exceptionally vigorous habit and require little detailed pruning; removal of entire canes is most appropriate. Berkeley, Bluetta, Coville, Weymouth, Patriot, and Blueray have a spreading habit. Bluecrop, Collins, Darrow, Earliblue, Herbert, Jersey, Lateblue, and Elliott have an upright habit which becomes dense in the center of the bush. Center canes are usually selected for removal.

When pruning blueberry bushes, aim for a plant with an upright growth habit and a sufficiently open canopy to allow light penetration (photos 36–37). Bushes that are to be harvested mechanically should be more upright and have narrower crowns than those that will be hand harvested. First, remove any canes with winter injury, disease or insect damage, or breaks. Second, cut away any cane that rubs against another, to prevent the spread of canker infections. Third, remove old canes and any that obstruct movement through the alley. Finally, cut out short, branched canes that never receive much light; any fruit they produce will ripen too late to be harvested. Be sure to cut canes as close to the crown as possible; stubs will rot and become a source of disease inoculum (photos 38–39).

Annual pruning is essential for stable production. Bushes tend to produce new canes the year after pruning; regular, moderate pruning encourages continuous regeneration, a constant proportion of fruiting wood, and steady yields.

Pruning practices vary as the plant ages. Little pruning is required on young bushes. Generally, only flower buds are removed for the first two years to promote vegetative growth. This can be achieved by rubbing off the fruit buds in March or April, or by pruning the tips of shoots where the flower buds are located. At the beginning of the third year, remove any twisted or low-growing canes to promote new cane production.

For 3- to 8-year-old plants in northern climates, if more than 2 new canes were produced the previous year, remove all but the 2 healthiest at the crown level. In subsequent years, continue light pruning until the plants reach full size, removing all but 2 or 3 of last season's canes. When plants are about 8 years old, they should contain between 10 and 20 canes of many different ages. Some varieties produce many more canes than others, so the amount of pruning that is required on young bushes will vary.

In southern climates, 3 or 4 new canes can be allowed to grow, and canes reach their maximum productivity by age 5. Mature plants should contain about 20 healthy canes; removal of the 3 or 4 oldest per year is recommended.

Canes start to lose their productivity at age 8; they require more leaves to produce enough energy to set the same amount of fruit. They have branched considerably, and flowers form on thin, weak growth. Annual removal of 8-year-old canes will cause a minimal reduction in productivity, as younger canes will replace them and new ones will develop. Such a system of renewal promotes consistent long-term productivity. In general, up to 20% of the older wood can be removed from a bush without adverse effects on yield. This is equivalent to the removal of one out of approximately 6 canes. Although berry numbers will be lower, larger fruit will compensate for this decrease.

### ***Detailed Pruning***

Removing injured wood should be the primary objective of detailed branch pruning in the tops of the canes. Branch pruning can result in higher fruit quality because berry numbers are reduced. Also, branch pruning can help relieve drought stress in hot climates where plantings are not irrigated. However, if one has done a good job removing whole canes, little detailed pruning will be required.

When removing branches from within the plant canopy, make cuts close to the main cane to which the undesirable branch is attached. Avoid leaving short, stubby branches, which are potential sites for disease infection.

### ***Rejuvenating an Old Planting***

When rejuvenating an old planting, remove most of the old, unproductive canes, but leave 2 or 3 older canes and all of the younger canes. In following years, remove up to 20% of the older wood until new cane growth occurs. Then keep 2 or 3 new canes and continue to remove up to 20% of the oldest canes. Eventually, the bush will become more productive, cane numbers will decrease, and bush stature will decline (photos 40–42).

In old, poorly maintained plantings, some growers have had success cutting all the canes to ground level; harvesting begins 3 years later. However, for this

system to be most effective, canes must be thinned to the most vigorous 6 to 10. Others find that summer hedging immediately after harvest, coupled with selective dormant cane removal, works well.

## **Mulching**

---

Maintain 3 to 5 inches of mulch in a 3- to 4-foot band centered under the plant, and replenish it every 2 to 3 years. Blueberry roots grow in the interface between the mulch and the soil; if the mulch decomposes and is not replaced, the roots will be exposed. Additional nitrogen fertilizer may be required after fresh mulch is applied (see chapter 5), usually about twice the recommended rate for a given year (see chapter 11).

## **Pollination**

---

A blueberry bush is capable of setting 100% of its flowers, although 80% set is considered a full crop. Insect pollinators are required to obtain this high level of set.

Blueberry pollen is shed from pores in the anthers onto the bodies of bees that vibrate the flowers. The pollen is sticky and heavy, and not transported by wind. Bumblebees and many native wild solitary bees are capable of “sonicating” or vibrating the pollen from the anther. Honey bees do not sonicate blueberry flowers, and collect less blueberry pollen. Carpenter bees can be a problem during pollination as they pierce holes in the base of the flower during nectar collection. Honey bees rapidly learn to use these holes, and thus, carry no pollen in the process (photo 43). Some species of bumblebees will chew holes in the blossom to collect nectar, especially in flowers with long corollas (petals).

Flowers with short corollas are more easily pollinated than those with longer corollas. Some attribute the consistent fruit set of Bluecrop to its shorter corolla, and the poor set of Earliblue to its longer corolla. Varieties also vary in their ability to attract pollinators. Earliblue, Stanley, and Coville are relatively unattractive to bees, whereas Rubel, June, and Rancocas are more attractive. Evidence suggests that attractive varieties produce more nectar than others.

Honey bees are not as efficient at pollinating blueberry flowers as some other types of bees. They forage less when the temperature is cool or wind speed is high, as is often the case during blueberry bloom. Bumblebees do not keep large food reserves in their nests, so they tend to be more consistent workers. Wild bees also have higher pollen requirements than do honey bees and are more likely to carry pollen. Maintaining thick fence rows along the perimeter of a planting is thought to encourage nesting by wild bees and aid with pollination. However, wild bees cannot always be depended upon to provide for the pollination needs of blueberries because of inadequate or fluctuating population numbers.

One rule of thumb is that 4 to 8 bees should be foraging on each blueberry plant at any one time during the warmest part of the day. In situations where bee activity is less than desired, honey bee hives can be moved in quickly and in large numbers. Hives should be in place when about 5% of the

flowers have opened, but no later than 25% full bloom, and they should remain until the petals begin to drop. Only strong hives should be used for pollination. One colony of 60,000 bees produces 50% more honey than 4 colonies of 15,000 bees. One hive (minimum of 45,000 bees) is generally sufficient for 2 acres of Rancocas, June, and Rubel; 1 hive per acre for Weymouth, Bluetta, Blueray, Pemberton, and Darrow; 3 hives for every 2 acres of Bluecrop; 2 hives per acre of Stanley, Concord, Berkeley, Coville, and Elliott; and 5 hives per 2 acres of Jersey and Earliblue. Place hives in a sheltered location with their entrances facing east; the bees will become active sooner if facing the morning sun. Distribute the hives throughout the field to maximize the probability of flower visitations. A maximum of 300 yards should separate groups of hives. Eliminate competing flowers (mow the dandelions and pigweed). Place a pesticide-free source of water near the hives. Make arrangements with the beekeeper in advance to remove the hives before insecticide spraying resumes; every effort should be made to protect bee populations from the harmful effects of pesticides. Once the majority of petals fall from the plants, the bees can be removed.

If fruit set is very poor, gibberellic acid sprays can be applied to increase set. This hormone induces parthenocarpic fruit set (seedless berries), but results in smaller, later-maturing fruit.

## ***For More Information***

---

Strik, B., and L. Ketchum. *A Grower's Guide to Pruning Highbush Blueberries*. Videotape. Corvallis, Oregon: Oregon State University, 1990.

Available from Oregon State University Cooperative Extension, Corvallis, OR 97331.

## Chapter 7

# NUISANCE WILDLIFE MANAGEMENT

---

Each year, thousands of dollars worth of blueberry plants and crops are lost to wildlife. Growers seem to be able to tolerate some loss as part of the cost of doing business, and most like to see some wildlife on their property until these losses significantly affect profits. When this occurs, a grower has little choice but to undertake management strategies to alleviate the problem.

Wildlife damage management has become more of a problem as large areas are planted to single crops, such as blueberries, and use restrictions for repellents and toxins have increased. While it is seldom possible to prevent total damage, much can be done to reduce wildlife impacts within legal and economic constraints.

## Birds

---

Damage to blueberries by birds is a serious problem. Recent studies estimate that as much as 30% of the crop is lost to birds in some years. Damage is most frequently caused by robins (*Turdus migratorius*), common grackles (*Quiscalus quiscula*), and starlings (*Sturnus vulgaris*), although other songbirds have caused significant fruit losses in some areas.

Blueberries are a good food source for birds, especially in dry years when natural food supplies are low. Some larger birds eat the berries directly, but much of the loss occurs when foraging birds knock the fruit off the bush. Some smaller birds puncture the fruit, creating a rot problem which can seriously jeopardize the quality of a pack. Punctured fruit is difficult to detect during harvesting and sorting operations.

All birds, except for feral pigeons (*Columba livia*), house sparrows (*Passer domesticus*), and starlings, are protected by the Federal Migratory Bird Treaty Act. However, Section 21.43, Title 50 CFR, states that, "A Federal Permit shall not be required to control red-winged, rusty, and Brewer's blackbirds, cowbirds, all grackles, crows, and magpies when found committing or about to commit depredations upon ornamental or shade trees, agricultural crops, livestock, or wildlife, or when concentrated in such numbers and manner as to constitute a health hazard or other nuisance..." All state and local laws must be followed, so a conservation officer should be consulted before implementing lethal avian control techniques.

**Exclusion** Netting is the most complete and effective method for controlling bird damage to fruit crops (photo 44). The cost of birdproof plastic netting varies considerably with the type, manufacturer, and quality. Plastic-impregnated paper, nylon, cotton, and polyethylene materials are available. The initial cost of netting may be quite high, but the cost can be prorated over the 3- to 10-year life expectancy of the material. The labor cost for installation and removal of netting is high.

Less expensive acrylic webbing is also available. The spiderweb-like material can be draped over bushes, but does not create the bird-proof barrier of plastic netting. This material is useful for only one growing season. Monofilament lines strung in a grid pattern at a 3-yard spacing reduced great-tailed grackle (*Quiscalus mexicanus*) damage to citrus groves in Texas. Preliminary cost-benefit analyses indicated that the use of lines was practical only in situations with severe damage. Lines have been used in other spacings and configurations to reduce damage caused by several bird species in a variety of non-orchard situations.

### **Auditory Frightening Devices**

Sounds may repel vertebrates due to pain, fear, communication “jamming,” disorientation, audiogenic seizures, or internal thermal effects. After a time, most animals adjust to and ignore new sounds through habituation. Audible sounds above 130 decibels and infrasonic or ultrasonic sounds above 140 decibels cause pain or sickness in vertebrates. Except for explosions, it is technically difficult and expensive to produce sounds louder than 130 decibels, and audible sound at high intensities is likely to be more of a nuisance for people than for birds.

Broadcasts of recorded distress calls have been used successfully to drive birds from fields or roosts (photo 45). Fields with taped distress calls often show less damage, but birds quickly habituate to the sounds. The use of recorded distress or alarm calls may have additional applications for bird damage management, but most calls are species-specific, so a grower must be able to identify the species causing damage.

Most other bird-control methods (bangers, crackers, poppers, bombers, sirens, etc.) rely on fear or perceived danger avoidance for their effect (photo 46). These techniques have been effective for only short-term control, as scare devices that produce sounds other than alarm or distress calls have no persistent effect on the use of space or food intake by vertebrate pest species. Numerous laboratory and field studies have found that:

- loud sounds are more aversive than quiet sounds
- sounds with a wide frequency range are more aversive than pure tones
- adult birds are more easily frightened than juveniles
- all species habituated to nearly all sounds.

Best results were obtained when:

- sound was presented at random intervals
- a range of different sounds was used
- the sound source was moved frequently
- sounds were supported by other methods, such as distress calls or visual deterrents
- sounds were reinforced by real danger, such as shooting.

Some manufacturers claim that ultrasound (frequencies above 20,000 hertz) has special properties that make it more aversive than audible sound. There

is no scientific evidence for this. No behavioral experiments have shown that ultrasound can be heard by, or is meaningful to, birds.

Blueberry growers with plantings near urbanized areas may experience conflicts with homeowners if sound-producing scare devices are used. Some towns have passed local ordinances restricting the use of auditory devices, and growers may wish to consider less offensive bird damage management techniques to avoid the proliferation of these local laws.

### **Visual Frightening Devices**

Several visual stimuli are reported to reduce bird damage to blueberries. Eye-spot balloons were reported to reduce great-tailed grackle damage to citrus groves, but the effective radius for these balloons in Massachusetts was found to be only 6 yards (photo 47). Balloons may be a more acceptable bird control practice in urban areas where sound devices could lead to conflicts. Too few experiments have been conducted to fully assess the value of eye-spot balloons, but they are reported to be more effective at deterring flocking birds than solitary species.

Tethered raptors, falcons, and raptor models have been used to frighten birds. Raptor-mimicking kites suspended from helium-filled balloons (hawk-kites) have been successful at reducing losses in vineyards, bird damage to blueberry fields, and have had mixed success for reducing blackbird damage to corn (photo 48). Problems with hawk-kites include their high labor requirements and vulnerability to wind damage or vandalism. Despite their effectiveness, hawk-kites are not a practical bird deterrent in most field situations.

Animated owl models (photo 49) and scarecrows in combination with propane exploders may be effective for frightening some bird species. A scarecrow, deployed to pop up in synchrony with a propane exploder, reduced blackbird damage to sunflower fields. Reflecting tapes placed 10 to 20 feet apart were effective in protecting small fields (under 1 acre) of sweet corn, millet, and sunflowers from bird damage. However, reflecting tapes spaced 10 to 15 feet apart did not protect blueberries from robin or starling damage. Reflecting tape was considered an impractical method for reducing grackle damage to citrus groves in Texas, as the tape frequently broke at connection points or became entangled in trees during high winds.

### **Traps**

Decoy-trapping prior to crop ripening can reduce bird populations and damage. In a New York cherry orchard, a single trap captured 4,000 starlings during the harvest season. Protected birds caught in decoy traps can be captured and released unharmed. Trapping may not be effective for flocks of birds that migrate seasonally because they arrive rapidly in large numbers. The value of decoy traps has not been fully assessed, and few research reports are available to determine cost-effectiveness.

### **Chemical Repellents**

Currently, there are no chemical repellents registered for protecting blueberries from avian damage. Until 1988, bird problems in most fruit crops were resolved by spraying the fruit with methiocarb (Mesurol). A review of the Mesurol toxicology data by the U.S. Environmental Protection Agency resulted in a reduction in the tolerance level from 100 ppm to 5 ppm in harvested fruit. Consequently, Mobay Chemical Corporation deleted cherries,



blueberries, and peaches from the Mesurol label. At the present time, there is no indication that this chemical will again become available for use as a bird repellent.

### **Cultural Practices**

Laboratory experiments have shown that several anthranilate and polysaccharide compounds are aversive to starlings. Additional field research is necessary to determine the cost-effectiveness of these repellents.

Planting location may influence the amount of bird damage to fruit crops. Fields near convenient perches, such as woods or power lines, may be prone to more bird damage. Plantings adjacent to forests or brushy fields may also be more susceptible to fruit losses, as some damage-causing bird species use these areas as protected nesting and roosting sites. Grass and weed control in and around the blueberry planting may reduce the numbers of certain seed-eating bird species. If possible, it is best to establish new blocks away from cover or perch sites, or remove these attractive habitat features from areas next to existing plantings.

## **Deer**

---

Deer damage is a concern to blueberry growers in many locations. Deer feed upon foliage, twigs, buds, and fruit; this can delay maturity and reduce yield of young plantings which can have substantial impact on profitability over the life of a planting.

Deer feeding damage is easily distinguished from damage caused by rabbits or rodents. Deer have no upper front teeth, and must pull or tear branches in order to remove the growing end or bud. Thus, branches fed upon by deer have a ragged, broken end compared to the cleanly nipped terminal left by other wildlife. In addition to feeding directly on the blueberry bush, male deer also cause damage during the fall by rubbing and breaking branches with their antlers. Antler rubbing occurs less frequently than browsing.

### **Developing a Control Strategy**

Deer are creatures of habit, and damage-management techniques are usually more effective when initiated prior to damage rather than after deer feeding patterns develop. In addition, controls initiated after feeding takes place cannot counter the effects of previous damage.

Growers should decide on deer-damage control strategies before establishing the planting. The decision to begin damage controls in existing plantings should be based on an assessment of the potential impact of future damage at a site, and not as a reaction to losses that have already taken place.

Damage is most effectively controlled using an integrated approach. Comprehensive strategies which include careful monitoring, deer population management, and one or more physical or chemical barriers to deer are most likely to successfully meet growers' needs. Control practices should be selected based on an assessment of the damage potential of the site, the effectiveness of available controls, their costs, and the degree of protection required by the grower.

The damage potential of new sites may be estimated based on a knowledge of local deer population levels, site characteristics, and deer activity in adjacent

areas. Damage potential will be greater in areas with greater deer densities, and where plantings are located adjacent to protective cover, such as woodlands or swamps. Estimates of deer abundance are available from regional conservation biologists. For a given deer density, the potential for damage will often be greater on large acreages than small acreages. Large acreages may, therefore, require more substantial control techniques to achieve the same level of protection. As expected, the cost of damage control programs increase as larger areas and more effective techniques are needed. However, damage programs for large acreages may be more cost effective, as per-acre costs are usually less.

Other deer “signs” might prove useful in assessing damage potential of a site. Counts of deer fecal pellet groups in adjacent woodlots are closely related to levels of deer population. Growers should make a conscious decision regarding the level of damage they are willing to tolerate, and should choose control techniques which are likely to meet this goal. Less effective or less expensive controls may be adequate if limited protection is necessary.

### **Population Control**

Annual reductions in deer numbers with sport hunting is an effective way to limit damage to blueberry plantings. Harvesting deer during the fall hunting season is often the least-costly damage control available to growers. In addition, reductions in deer numbers can enhance effectiveness and reduce expenditures of other control practices.

Deer have the capacity to nearly double their population size annually in the absence of predation or hunting mortality. It is nearly impossible to kill enough bucks to prevent nearly all adult does (females) from being bred, and it is essential to harvest female deer in order to stabilize or reduce deer populations.

Outside the hunting season, growers may apply to the state for crop damage permits, which allow landowners to destroy deer causing damage. However, this practice is time consuming and may result in only limited damage reductions. Damage permits should be considered temporary solutions until more effective long-term control practices can be implemented.

### **Physical Barriers**

Deer damage may be effectively controlled using a variety of physical barriers. Barriers such as fencing perform well even under intense deer pressure, and represent the technique of choice for many control programs.

Only 3 basic designs are currently used to protect blueberry plantings. These include conventional nonelectric, 8- to 10-foot woven-wire fences, and shorter, multi-strand, vertical or slanted electric fences constructed with high-tensile smooth wire and components (photo 50). *High-Tensile Wire Fencing*, NRAES-11, discusses fence construction and maintenance for deer control.

### **Chemical Repellents**

Repellents are one of the most popular deer damage control products used by blueberry producers. Repellents are thought to interrupt deer feeding by having an unpleasant taste or disagreeable odor. Generally, repellents are most effective when deer pressure is low to moderate, and when deer damage is expected to be light to moderate. The effectiveness of repellents has been highly inconsistent, and growers using repellents should be prepared to

tolerate some damage, even when deer pressure is low. Repellents do not seem to prevent antler rubbing.

Three commercial products have proven useful in preventing deer damage. BGR Deer-Away (IntAgra, Inc.) is a putrescent egg-based product that has consistently been shown to be one of the most effective commercial repellents available. BGR Deer-Away is believed to act as a taste- and odor-based repellent. However, the cost of BGR Deer-Away may exceed \$12 per gallon of finished spray, and this expense limits the large-scale use of this product in commercial plantings.

Hinder (Uniroyal Chemical Co., Inc.) is an odor-based repellent with active ingredients of ammonium soaps of higher fatty acids. Hinder is relatively inexpensive (less than \$1 per gallon of finished spray).

In addition to commercial products, a variety of homemade materials have been used to repel deer. These include blood meal, tankage (dried animal wastes or sewage sold as fertilizer), human hair, kerosene-soaked rags, creosote-soaked rags, and mothballs (naphthalene). Motel-size soap bars hung from bushes are a common damage deterrent used by blueberry growers.

Homemade repellents are attractive due to their low cost, but they may be less cost effective than commercial repellents when their labor requirements are considered in their total cost. In addition, the effectiveness of homemade repellents, like the commercial products, is often highly variable. These materials lack an Environmental Protection Agency registration number, and their long-term effects on the environment have not been evaluated.

Growers using repellents should frequently monitor their plantings for damage and respond before it becomes widespread. Like other controls, repellent applications are most effective if made before damage occurs and a feeding pattern is established. This is best accomplished by making scheduled repellent application based on observed seasonal patterns of deer damage. Previous experience with damage at a site will allow the grower to make applications prior to expected periods of heavy damage. During the growing season, repellents (particularly taste-based products) may need to be reapplied every 3 to 4 weeks to cover new growth. Dormant season repellent programs may require an additional 2 or 3 applications.

Repellents should be applied when precipitation is not expected for 48 hours and temperatures will remain between 40 and 80°F. Damage control using repellents is most cost effective on small acreages and when no more than 2 to 3 applications are needed annually. Growers who need to control deer year round may be unable, then, to use repellents.

### **Scare Devices**

A variety of frightening devices, including scarecrows, strips of cloth or metal, lights, whistles, and loud noises produced by firearms, carbide cannons, and explosives have been used to scare deer from plantings. Scare devices work best for short-term protection, or when used in combination with other control techniques. A device called the "Deer Fly," which gives off short, irregularly-spaced blasts of sound, effectively reduced deer damage in some fruit plantings. In contrast, the AV-ALARM electronic bird-frightening device,

which combines light and sound stimuli, failed to reduce deer damage to field crops or forest seedlings, although it was described by the manufacturer as 100% effective at repelling deer from fruit plantings.

Several dogs chained to wires running along the perimeter of a planting have been reported to help deter deer damage, but the care of the dogs may render this method impractical. Deer can quickly become accustomed to a dog and its barking. Scare devices may be effective initially, but invariably deer become habituated to them and resume causing damage. In addition, many of the devices are expensive, have high maintenance requirements, and may be dangerous to humans and animals.

### **Cultural Practices**

Crops that deer prefer could be planted near blueberries in an attempt to draw deer away from more valuable blueberry bushes. Unfortunately, little research has been conducted on the use of this technique. Deer have been shown to be attracted to vegetation sprayed with a solution of molasses and minerals.

Many individuals have proposed the use of predator urine or feces to repel deer. However, these products have not proven more effective than conventional repellents, and the difficulty in obtaining large quantities of these materials limits the feasibility of their use in commercial operations. Further research to identify and synthesize the repellent components of these materials may be warranted.

## **Voles**

---

Two species of voles, meadow voles (*Microtus pennsylvanicus*) (photo 51) and pine voles (*M. pinetorum*), may cause significant damage to blueberries. These rodents most frequently damage plants during late fall through early spring when other food sources are limited. Damage consists of gnawing the phloem and cambium tissues on the canes' large lateral roots. Severe vole damage may reduce plant vigor, lower fruit yields, and increase mortality.

### **Meadow Voles**

Meadow voles are known locally by several common names, including ground moles, field mice, meadow moles, and voles. This can lead to misidentification of the problem species. Eastern moles (*Scalopus aquaticus*) seldom venture above ground and occupy an extensive tunnel system. Their front toenails are greatly enlarged for digging, and their hind legs are small. Moles have a more pointed snout with sharp pointed teeth for catching grubs and earthworms. Their fur is short, soft, and velvety, and when brushed, offers no resistance in either direction. In contrast, adult meadow voles are small rodents about 7 inches long. The tail of the meadow vole is about 1 $\frac{3}{8}$  inches, or approximately twice the length of the hind foot ( $\frac{3}{8}$  inch). Adult meadow voles are chestnut brown mixed with black on the back, with dark gray underparts. Like other rodents, they have sharp incisors for gnawing vegetation.

Meadow vole populations fluctuate seasonally, and if allowed, can increase rapidly to economically damaging levels. Females are capable of breeding at 26 days of age, have a gestation period of only 21 days, and often produce 5 or 6 young per litter. Females may produce 5 to 10 litters per year. A few meadow voles in spring can produce threatening numbers by fall. Meadow voles are promiscuous, and females are territorial in the breeding season.

Meadow voles travel through fruit plantings in surface runways constructed by clipping vegetation at ground level. Home range sizes vary for individual animals, but 0.05 acre is typical. They do not inhabit wooded areas, but can be abundant in other agricultural habitats, wet grasslands, and along roadsides. Signs of meadow vole damage include bark removal or girdling of canes near ground level. Tooth marks of voles differ from those of rabbits (*Sylvilagus floridanus*) in that they are smaller and occur at various angles on the cane. Damage to canes may occur as high as the snow accumulates during winter, and young canes are more susceptible to vole attacks.

Meadow voles may dig shallow burrows and damage roots in heavily mulched soils, but this type of damage is more commonly caused by pine voles.

**Pine Voles** Pine voles resemble meadow voles, but are smaller (4 to 5 inches), with shorter tails ( $\frac{5}{8}$  inch) and smoother fur. The tail of a pine vole is about the same length as its hind foot, a characteristic that readily distinguishes them from meadow voles. Adults are chestnut brown. Female pine voles cannot breed until they are at least 33 days old. With a longer gestation period (24 days) and smaller litter sizes (2 or 3), pine voles have a lower reproductive capacity than meadow voles.

Pine voles are more social than meadow voles, and live in extended family units. A typical family unit may consist of two adult males, one adult female, and one to two juveniles and subadults. Pine voles appear to be monogamous, and only the dominant female breeds in a family unit. Pheromones may delay reproductive maturity of subadult females by as much as 83 days.

Pine voles seldom use surface runways, and usually travel in extensive subsurface tunnel systems established within the dripline of plants. Therefore, damage caused by this species is usually confined to the canes and major lateral roots below ground level. Food is stored in their subterranean tunnels. Home ranges of pine voles are much smaller than those of meadow voles, and average about 0.01 acre. Low populations of pine voles may inhabit deciduous woodlands.

**Assessing Vole Populations** Vole populations fluctuate annually, with the yearly maximum at the end of the current breeding season (early winter), and the minimum at the onset of the next breeding season (spring). If the decline in vole numbers during winter is slight, a peak production year is likely to follow. However, levels are not uniform, even within small areas, making it difficult to predict economic thresholds for damage. Feeding indices can be used to determine population status and treatment.

**Exclusion** Meadow vole damage to young plants may be reduced by installing plant guards. Galvanized hardware cloth cylinders ( $\frac{1}{4}$  inch mesh) at least 24 inches wide can be installed around the base of young plants. Wire cylinders should be taller than the maximum expected snow depth, as voles will climb over the top of the guards if they are buried by snow. Guards will not prevent damage caused by tunneling pine voles.

**Trapping** Snap-back traps are often used to estimate vole numbers in research plots. Almost complete removal can be accomplished in 3 to 5 days, if trapping is done when voles are susceptible. Trapping success is enhanced by baiting

with apples and covering the trap with a roofing shingle. This method will be impractical for large plantings due to the number of traps required, the time necessary to set and check traps, and difficulty in capturing trap-shy individuals. Sherman box traps can also be used to capture voles, but these traps are more expensive than snap traps and require the same labor costs.

Trapping is probably most useful for obtaining a positive identification of the vole species causing damage. Trapping will provide emergency control of vole numbers for small blocks where chemical rodenticides cannot be used.

### **Chemical Control**

Rodenticide applications are the most frequent method used by growers to reduce vole numbers. Voles generally are not grain eaters, but most commercial baits are grain-based, resulting in much variability in bait acceptance. Voles may develop bait shyness if they ingest a sublethal dose at their initial feeding. Consequently, chronic (multiple-dose) anticoagulant rodenticides have been developed to avoid this problem, but these may not be registered in your state.

Pine and meadow voles are affected differently by rodenticides due to differences in their feeding behavior and ecology. Meadow voles may be successfully controlled by broadcasting baits throughout the field and adjacent cover. In contrast, broadcast baiting with grain baits was found to reduce pine vole populations only slightly, but hand placement of pellets in or near active burrows reduced numbers significantly.

Voles are more likely to accept pelletized baits. However, many pelletized bait formulations readily absorb moisture and are more susceptible to deterioration than grain baits in rainy weather. Spoilage of baits has advantages and disadvantages. The potential hazard to nontarget species is reduced if baits weather quickly, but the vole control effectiveness may be lower. Voles take baits in small plastic packets, which repel moisture. Placement of baits under protective covers (shingles, split tires, etc.) will attract voles, reduce nontarget species losses, and reduce exposure to the weather.

Some growers have had success with field bait stations constructed from 1½ inch diameter polyvinyl chloride pipe glued together in a T shape. Bait stations can be supported by a stake, and a protective cover can be made by cutting out the top of a soda can.

Repellents are seldom used for vole control. Repellents have been shown to be superior to rodenticides in laboratory studies where rodents are presented with only repellent-treated wood and roots. However, in field applications, tunneling voles will gnaw on untreated roots and stems below ground level. Repellents would be ineffective for pine vole control due to their habit of feeding on root systems.

### **Cultural Practices**

Blueberry growers often use perennial ground covers between rows to reduce soil erosion and maintain soil structure. Unfortunately, ground cover vegetation may provide an ideal environment for voles which will lead to increased crop damage. The plant species composition and the density and structure of ground cover appear to influence vole numbers and activity. Meadow vole activity was more than 4 times higher in test plots with sod grass than those

with small grain ground cover, and voles favored 'Elka' ryegrass (*Lolium perenne*), red fescue (*Festuca rubra*), and bentgrass (*Agrostis tenius*).

Ground coverage between 40 and 90 percent is strongly correlated with vole activity, while little vole activity is noted below 40% ground cover density. Herbicide-treated or cultivated strips within the rows and close mowing of ground covers can significantly reduce vole damage.

**Biological Controls** The use of natural predators (hawks, owls, foxes) to control vole numbers has not received much attention. Predator populations usually lag behind those of prey species, and relatively low numbers of voles can cause significant economic losses. When vole numbers are near the annual peak during late summer and fall, predators may no longer be reproducing and cannot respond to the increase in prey abundance. Mowing, spraying, picking fruit, and other activities may disturb predators and decrease their effectiveness.

## **Pocket Gophers**

---

In the Pacific Northwest, one of the greatest hazards to plantings of all ages is injury from pocket gophers (*Thomomys* sp.). These animals dig extensive tunnels or runways which may extend as far as 800 feet and cover an acre of land. Because they feed on plant root systems, extensive damage can occur before symptoms are evident above ground. Gophers are seldom seen; they spend almost their entire lives underground.

Pocket gophers are active throughout the year. Breeding generally begins in the early spring when adult females allow the males to use their burrow systems. After breeding, the female drives the male out of the burrow. He then begins digging another burrow, generally in a straight line, until he finds another receptive female. After the breeding season, both the male and female live solitary lives unless the female is raising a litter (4 to 7 young). After the young have grown, they are forced from the burrow where they migrate, sometimes above ground, to new, uninhabited areas.

Pocket gopher activity is more evident in the spring and fall when new burrow systems are excavated and the loose soil pushed above ground. During the remainder of the year some new mounds may appear but the majority of the animal's activity goes unnoticed.

Most people have found that direct control strategies are easier and more effective in the fall when the gophers are the most active, less effective in the spring, and practically useless in the winter and summer when their burrow systems are hard to find.

**Indirect Management** Pocket gophers can often be excluded from small areas by building barriers, generally 3 or more feet deep, around the perimeter of a planting. Barriers should be solid objects, either concrete or wire, that the animal cannot dig or chew through.

Predators such as hawks and owls can be encouraged by putting up perching poles and nest boxes throughout the area. While predators will not eliminate the animals, they will remove some of those that venture above ground in search of food or to migrate.

Changing the gopher's living conditions, by either reducing or eliminating their source of food, has the most profound and long-lasting effect. When a food source is eliminated, animals have two options: move or die. Eliminating a food source such as grass strips between plantings can, however, have unwanted effects. Existing gophers are forced to the remaining food source—the blueberry roots.

### ***Direct Management***

When indirect management strategies are not feasible or where damage cannot be tolerated, traps, fumigants (gases) and toxicants (poisons) can be applied directly within gopher burrows. A probe made of a piece of ½ inch pipe about 35 inches long with a solid, pointed end will help locate the burrows. The main runway will be 15 to 18 inches from mounds; the gas should be inserted into this opening.

#### ***Trapping***

Autumn is the best time to trap because gophers are most active. Regular steel-jawed traps (size 0 or 1) can be used. Several types of gopher traps may be purchased at most hardware stores, including specially designed traps that kill the gophers. Set traps far back into freshly worked tunnels. Attach a piece of wire to the trap and fasten the other end to an anchoring metal stake so the gopher cannot pull the trap away. Set and place two traps, one facing in each direction. Place the trigger (flat metal plate) away from the excavation. The open burrows attract the gophers, and they will be caught while trying to plug the holes.

Do not leave large openings, or gophers will push soil ahead of them, springing the trap without being caught. Check your traps often so they may be reset when necessary.

#### ***Fumigants***

Gases can be used with small to medium-sized populations. Most are effective in wet, heavy soils where the gases remain in the burrow system to asphyxiate or suffocate the animals. None are recommended for light sandy or dry soils where the gases rapidly dissipate out of the tunnels. Several types of fumigants can be used: exhaust from diesel or leaded-gas engines, pellets or tablets, and cartridges.

- **Engine exhaust.** Locate burrows and tunnels as described above. Insert a flexible tube from the engine's exhaust into the burrow and let run for at least 5 minutes. Any less time will only give the animal a headache.
- **Pellets and tablets.** Instead of inserting an exhaust tube, place two pellets or tablets into the hole, cover with water to activate them, pack with wadded paper (to prevent the animal from pushing them out), and refill the hole with packed soil.
- **Cartridges.** Find the burrow system. With gloved hands, insert a lighted cartridge as far into the burrow as possible without getting burned, and cover immediately with soil. Monitor the area for escaping gas and, where found, cover with packed soil.

#### ***Toxicants***

Two basic types of poisons can be used to kill gophers: acute and subacute. Acute toxicants are those that kill the animal in a short period of time, generally within a few hours. Subacute toxicants are those that require multiple feedings (doses) before the animal becomes sick and dies.



- **Hand baiting.** Locate the main runways by probing for pocket gopher runways 12 to 18 inches from mound and 6 to 10 inches below ground surface. Deposit 1 to 2 tablespoons of commercial bait in each runway. Cover probe holes with rock or soil. Follow rodenticide package labels. Mixtures of paraffinized grains and anticoagulant rodenticides (called bait bars) have recently been developed for gophers.
- **Mechanical trail baiting.** Burrow builders are most effective when large populations, covering many acres, are to be treated over a short period of time. They should only be used where gopher mounds are present. The machine should be removed from the ground, between infected areas, so that survivors do not invade the treated area.

Several types of burrow builders have been designed to construct artificial burrows. The most effective is a tractor-drawn implement similar to a mouse-baiting machine. The implement should be set at a depth that will intercept natural tunnels (about 6 to 10 inches deep). Burrows should be located 20 to 30 feet apart. Bait is dispensed through a tube into the underground burrows.

Make applications in either fall or spring when the soil is moist. For best results, the soil should be moist enough to pack when squeezed by hand. Mechanical burrow building is not effective in dry or rocky ground.

## **Woodchucks**

---

Woodchucks (*Marmota monax*) are ground-dwelling members of the squirrel family found in agricultural lands throughout much of North America (photo 52). Adults weigh from 5 to 12 pounds and produce 2 to 8 young after approximately 32 days of gestation. Woodchucks are true hibernators, and generally remain in underground burrows during late November through early March. Burrows are commonly located in fields, or pastures; along hedgerows, stonewalls, or roadsides; or at the bases of trees. Woodchuck burrows serve as important refuges for many other wildlife species.

Woodchucks commonly occupy fruit plantings, nurseries, and other crop-production areas. They may cause damage by digging burrows and building associated dirt mounds which can damage farm machinery; digging at the base of plants and uprooting them or exposing their roots; or by gnawing or clawing on the bark of canes. Gnawing occurs primarily during the spring, and functions more frequently as a scent-marking behavior rather than feeding. Woodchuck damage can be distinguished from vole damage by the larger size of the incisor marks ( $\frac{1}{8}$  to  $\frac{3}{8}$  inch wide) left on the canes.

### **Population Control**

Woodchucks are not protected game animals in many states, and therefore can be hunted throughout the year without limit. Fruit growers usually rely on lethal controls to reduce woodchuck damage. Spring is the best time to use lethal controls, since the animals are active and their young may remain within the burrow at this time. In addition, burrows are more evident before annual vegetation conceals their entrances, and other animals are less likely to use burrows as shelter at this time.

One common control practice is fumigation with commercial poison-gas cartridges made of a cardboard cylinder filled with chemicals. Seal all en-

trances to an active burrow, then place a lighted cartridge into it. Use caution to prevent smoke inhalation and accidental fires. Do not use gas cartridges in burrows under sheds or buildings, or near combustible materials. Be sure to follow all label directions when using fumigants. Fumigants are not effective on hibernating woodchucks.

Shooting and trapping are other techniques used to remove problem woodchucks. Shooting may be illegal or unsafe under some circumstances. Woodchucks can be captured using #2 leghold traps or box live traps baited with apples and set near burrow entrances. Check traps at least twice daily. Do not use leghold traps where they might inadvertently catch pets, livestock, or any other nontarget animal.

Lethal controls have been reported to have limited success in controlling woodchuck populations. In one study, 28% of the burrows gassed by a landowner were reoccupied within 2 days, and 83% of the burrows were reoccupied within 2 weeks after treatment. The rapid reoccupation of burrows may have resulted because the treatment was applied during the day when woodchucks are least likely to be inside burrows, and because more than one animal may use a burrow system. In addition, studies indicate that individual woodchucks may have home ranges of several acres, and may use many different burrow systems. This increases the chance that active burrows may be empty at the time they are treated. Similarly, shooting and trapping may not eliminate woodchucks from a planting.

In one Pennsylvania study, 1,040 woodchucks were removed from a 600-acre site over 4 years without significantly affecting the population size. The population was unaffected due to increased juvenile survival, increased birth rates, and movement of woodchucks onto the site from surrounding areas. The rapid invasion of woodchucks from surrounding areas into unoccupied burrows necessitates that control practices be carried out beyond the blueberry planting in order to reduce populations.

### ***Physical Barriers***

Fencing can be effective at reducing woodchuck damage, but is probably not practical for commercial growers. Woodchucks may be excluded from small areas with a 4-foot high hardware cloth fence buried 10 to 12 inches with an electric hot-shot wire located 4 to 5 inches high and an equal distance away from the outside of the fence. Electric, high-tensile deer fences may be modified to exclude woodchucks by adding additional wires at 5- to 6-inch intervals up to 18 inches high.

### ***Repellents***

Commercial deer and rabbit repellents, as well as some insecticides thought to have repellent properties, are generally ineffective at preventing woodchuck feeding.

### ***Habitat Management***

Modification of habitats in and around blueberry plantings can help reduce attractiveness to woodchucks, and can increase the effectiveness of other control techniques. Elimination of brush piles and overgrown areas will facilitate finding and treating burrows.

## For More Information

---

Curtis, P. D., M. J. Fargione, M. E. Tobin and S. C. Frantz. *1990 Pest Management Recommendations for Control of Vertebrates*. 1990.

Available from Distribution Center, 7 Research Park, Cornell University, Ithaca, NY 14850. (607) 255-2080.

Agricultural Extension Committee on Deer Damage and Control. (Publications listed by number and title below.) 1985–1990.

806 Fundamentals of Deer Management

807 Deer Control in Home Gardens—Repellents

808 Repellents for Deer Control

809 An Integrated Approach to Deer Damage Control

810 High-Tensile Fencing for Deer Control

811 Deer Control in Home Gardens—Fencing

812 High-Tensile Woven and Smooth Wire Nonelectric Fence

813 Maintenance and Safety for High-Tensile Fence

814 6-Wire Vertical High-Tensile Electric Anti-Deer Fence

815 Deer Behavior

816 Slanted High-Tensile Anti-Deer Fence

817 3-Wire 2-Dimensional High-Tensile Electric Fence

818 Nature of Potential Damage by Deer to Corn and Alfalfa

819 High-Tensile Fence—Do's and Don'ts

820 Identification of Deer Damage

821 Troubleshooting High-Tensile Fences

Available from Art Selders, Agricultural Engineering Extension, 2078 AS-WVU, Morgantown, WV 26506-6108. (304) 293-5539.

———. *High-Tensile Fences and Their Construction*. Videotape. 1990.

Available from Art Selders, Agricultural Engineering Extension, 2078 AS-WVU, Morgantown, WV 26506-6108. (304) 293-5539.

Selders, A. W., and J. B. McAninch. *High-Tensile Wire Fencing*. NRAES-11. Ithaca, New York: Northeast Regional Agricultural Engineering Service, 1987.

Available from NRAES, 152 Riley-Robb Hall, Cooperative Extension, Ithaca, NY 14853. (607) 255-7654.

Swihart, R. K., and M. R. Conover. *Strategies for Reducing Wildlife Damage in Orchards*. Bulletin 855. 1988.

Available from The Connecticut Agricultural Experiment Station Publications, Box 1106, New Haven, CT 06504.

Ellingwood, M. R., and S. L. Caturano. *An Evaluation of Deer Management Options*. Publication #DR-11. 1988.

Available from W. Hesselton, United States Fish & Wildlife Service, 1 Gateway Center, Newton Corners, MA 02158.

## Chapter 8

# ARTHROPOD MANAGEMENT

---

A great number of species of insects and mites may be found on highbush blueberries in the United States and Canada. The pests described in this section have been selected on the basis of their potential for crop damage, frequency of occurrence, and importance for recognition and management.

Pests have been grouped by the type of plant parts which they infest or injure: buds, flowers and fruit, leaves and shoots, and woody stems, crowns and roots. A description and life history, comments on damage and importance to production, and methods of monitoring and control, if determined, are presented for each pest group.

Integrated Pest Management programs for blueberries are still in their infancy. Pest problems vary greatly across the area where blueberries are grown, few thresholds have been developed, and legal control methods differ among states. The information in this chapter can serve as a foundation upon which to build a comprehensive IPM program for arthropod pests.

## ***Pests Infesting Buds***

---

***Blueberry Bud Mite*** *Acalitus vaccinii* Keifer  
Acari:Eriophyidae

***Description and Life History*** Blueberry bud mites are whitish in color and approximately  $\frac{1}{128}$  inch long. Unlike other mites, they are elongate and conical, with eight legs bunched near the head at the broad end of the mite. Heavily infested buds have a definite reddish coloration and characteristic rough bumps on the outer bud scales. Eggs and immature and adult mites are present throughout the year. They are generally confined to the buds and blossoms. During the fall and winter, many mites may be found between the scales of a single fruit bud.

***Damage and Importance*** Bud mites feed on the surface of the bud tissues and bud scales. Injured buds desiccate and usually produce distorted flowers. These flowers may fail to set fruit, or develop into fruit with rough skins (photo 53). The potential for damage differs with variety.

***Monitoring and Control*** Plants should be inspected for bud mites in September, before the new buds are well formed. Look for them under bud scales and between bud parts. Economic threshold levels have not been determined for bud mites. Thorough pruning of infested canes provides good control of bud mites. Limited chemical control measures are available.

***Cutworms*** Various species  
Lepidoptera:Noctuidae

***Description and Life History*** Several different species of cutworms may be damaging to highbush blueberry, depending on the growing region and alternate host plants in the area. These insects are usually a greater problem in mulched or sodded fields than

they are where clean culture is practiced. Larvae are shaped like typical caterpillars, with cylindrical bodies, three pairs of true legs just behind the head and five pairs of fleshy prolegs supporting the rest of the insect (photo 54). The larger species may grow to 1½ inches. Cutworm larvae usually hide in the leaf litter or duff in the crown of the bush during the day. At night they climb into the bushes and feed on swelling buds. After feeding has ceased, they form pupae in the soil or in a flimsy cocoon in the leaf litter. Adult moths are typical for the family Noctuidae, generally shades of gray, black, and brown in subtle patterns; most have a wingspan of approximately 1 inch. Depending on the species, cutworms overwinter as adults, eggs, larvae or pupae. Those which overwinter as larvae are usually most destructive, as they commence feeding during the first few warm days of spring and may consume many buds before they are detected and controls can be applied.

**Damage and Importance** During bud swell and early bud break, cutworm injury appears as missing buds or with a large proportion of the bud eaten away (as opposed to spanworm injury, which looks more like the bud has been bored out through a distinct opening). Production can be severely reduced as each bud lost represents a large number of potential berries.

**Monitoring and Control** Cutworms can often be found by searching through the leaf litter, duff, or upper layers of soil below damaged bushes. Examining the bushes in the evening or early morning may reveal cutworms in action. Economic threshold levels have not been determined for cutworms on blueberry. Control of cutworms is very difficult due to their unpredictable activity patterns, early season timing, and twilight feeding habits. No pesticides are labeled for their control on blueberries. Clean culture methods can significantly reduce cutworm populations; maintaining weed-free strips under the bushes with light tillage or herbicides also controls cutworms to some degree.

**Spanworms** Spring Cankerworm, *Paleacrita vernata* Peck  
 Fall Cankerworm, *Alsophila pometaria* Harris  
 Chain-spotted Geometer, *Cingilia catenaria* Drury  
 and other species  
 Lepidoptera:Geometridae

**Description and Life History** Several species of spanworm are known to feed on blueberry in the eastern United States. Spanworm larvae tend to be thin and cylindrical, with the number of prolegs reduced to two pairs at the posterior end of the caterpillar (photo 55); they often move by “looping” their bodies and will frequently assume a stick- or branchlike pose to hide from predators. Larvae build flimsy cocoons from leaves and silk, or burrow into the soil to pupate. Adult spanworms, known as geometers, are small- to medium-sized moths with angular wing margins. The female moths of the spring and fall cankerworms are wingless. Various species of spanworms can be present on blueberry plants throughout the growing season, but only those which feed on swelling buds in the spring cause any significant damage to production or growth.

**Damage and Importance** Early season spanworms feed on swelling buds by chewing a hole through the side or tip of the bud and then feeding on the interior of the bud. Injured buds often appear to have been bored out through a small hole. These buds usually

die entirely and fruit production can be significantly reduced. Other species that occur later in the growing season feed mainly on succulent leaves and never seem to be numerous or damaging to bushes in commercial plantings.

**Monitoring and Control** Spanworms can be found by examining the buds and terminal growth in the spring; they may also be knocked from the branches onto a beating sheet. Economic thresholds have not been determined. Spanworms are usually kept in check by prebloom treatments made against leafroller pests. Bacterial insecticides are used if bees are present on blooming fields.

**Winter Moths** *Operophtera brumata* Linn. and other species  
Lepidoptera:Geometridae

**Description and Life History** The winter moth is an introduced species which has been known in Oregon since about 1958; it has recently become a pest of blueberries in Washington. It is an extremely damaging pest when it becomes numerous, and it can defoliate many landscape plants including maple, birch, willow, and alder. There is a complex of moth species that is collectively called “winter moth” or “spanworm.” The life cycles and habits are so similar that it is not important to distinguish between them for control purposes.

In November and December the wingless female moth crawls up the branch of the bush and lays her eggs in bark crevices of branches and twigs. The eggs remain in the bark until March or April, when they hatch into tiny colorless larvae (about 1/16 inch). These little worms move up and bore into swelling buds. They feed inside the buds and the buds die. The larvae later move from the buds to the leaves, where they may do some feeding. At this stage they are green with a light stripe down the side, and they move like inchworms. They spin silken threads and may tie leaves together; however, they can be distinguished from leafrollers in that they do not roll the leaves lengthwise. In June or July they drop to the ground to pupate under debris. Winter moths produce only one generation per year.

**Monitoring and Control** In view of their potential for destruction in blueberries, it is important to monitor for these moths. The first evidence seen will be brown buds which fail to open (similar to winter injury). A hole in the side of the bud, fine silken threads, and frass at the base of the bud may also be seen. However, by this stage it is too late for control measures. Sampling should begin before the buds turn brown, around the end of March. Open the buds and look for a very small worm with a shiny black or pale green head. Winter moth larvae prefer flower buds over leaf buds. They are more frequent in warm areas of the field and in areas near other deciduous hosts.

## ***Pests Infesting Flowers and Fruit***

**Cranberry Weevil** *Anthonomus musculus* Say  
Coleoptera:Curculionidae

**Description and Life History** Also known as the blueberry blossom weevil, this insect can be a serious problem in New Jersey and Massachusetts. It is a small (1/16 to 3/32 inch) brown beetle with a few whitish markings on the elytra (photo 56). The insect’s mouthparts are positioned at the end of a short snout. Adult weevils

overwinter under debris and fallen leaves, primarily in wooded areas, fence rows, and sometimes in blueberry fields if they are unkept and weedy. Adults become active on warm days in the early spring and often appear on bushes before bud swell; they retreat to hiding places if the weather cools, so they are difficult to monitor. Adults occasionally feed on swelling buds, but the majority of their activity occurs once individual flower buds separate and become visible within fruiting clusters, but before the flowers open. Feeding injury looks like tiny holes drilled into buds or through the corolla of flowers (photo 57). If leaf buds are attacked, the result may be small round holes in the first leaves developing from the bud or the complete destruction of the leaf shoot. When the weevils attack flowers, they feed on developing anthers, stamens and often the pistils. It is possible for flowers injured by weevil feeding to bloom and set fruit if the pistils are not severely injured. Female weevils insert their eggs through feeding holes; usually only one egg is laid in each flower. The egg is minute, elongate, and translucent when deposited; it usually adheres to the pistil or stamens. The female weevil will sometimes bore a small hole in the flower pedicel to provide a weak point at which the flower later breaks from the plant. A small white, legless, C-shaped grub with a brown head hatches from the egg and consumes the internal parts of the flower. Where pupation occurs, infested flowers do not open; they turn purplish and eventually fall to the ground. Adults emerge later in the summer; they are believed to complete another generation on cranberry or other ericaceous plants.

**Damage and Importance** The blossom weevil is a sporadic pest, not causing significant damage every year. Certain fields, due to the conditions in surrounding areas, tend to have greater or more frequent problems with this insect. When populations are high, a great deal of production can be lost; feeding damage may occur to every blossom on a bush, and hundreds of blossoms per bush may be infested by the grubs. Infested flowers fall from the plant well before harvest, so this pest is rarely a contaminant of the berries.

**Monitoring and Control** Adult weevils are difficult to observe on blueberry bushes due to their cryptic coloration and infrequent activity; look for them on warm, sunny days during bud swell through bloom. They can be knocked from the bushes onto a sheet, where they are more easily seen. It is simpler to examine the buds for weevil feeding punctures. In New Jersey, university recommendations suggest control action if there are greater than five adults per bush or if one or more feeding punctures can be found per five blossom clusters and the adults are still active. Clean cultivation to eliminate overwintering sites has provided good control.

**Cranberry Fruitworm** *Acrobasis vaccinii* Riley  
Lepidoptera:Pyralidae

**Description and Life History** This insect overwinters as a fully grown larva within a cocoon made of silk and soil particles. The cocoons are frequently made under weed and debris on the soil surface, but they may be deeper. The larvae pupate in the spring and complete development, with the adult moths emerging after bloom and fruit set. Adults are small, night-flying moths with dark grayish-brown wings; fresh specimens have two white markings on each forewing (photo 58). The eggs are deposited on the berries, almost always on or inside the calyx cup.

The eggs are very small and difficult to see without a hand lens. They look like flat white scales with small yellowish to reddish areas near the center. Hatched eggs appear brighter white; eggs that have been parasitized by a small wasp appear black and will not develop into larvae.

The young larvae immediately bore into the fruit, usually entering the berry near the stem. A single larva may feed within as many as eight berries to complete its development; they move from one berry to another within a cluster and usually web the berries together with silk. The larvae attain a length of about  $\frac{3}{8}$  inch and are usually greenish, sometimes light brown along the back. The frass of the larvae fills the tunnels in the berries and cling to the silk webbing, producing very messy feeding sites (photo 59), which easily distinguish cranberry fruitworm damage from cherry fruitworm damage. Mature larvae leave the berries and move to the soil to form cocoons. There is a single generation each year.

Wild blueberries and cranberries are often heavily infested with the cranberry fruitworm; if commercial fields are nearby they will likely have problems with this pest. Weedy, unkept plantings are also likely to have higher populations of this insect.

**Damage and Importance** The cranberry fruitworm is one of the most serious pests of blueberries in the eastern U.S. Some fields have suffered 50 to 75% losses of fruit, with earlier varieties usually being the most infested. Infested berries may be harvested without detection, resulting in inspectors or consumers finding larvae in packaged berries.

**Monitoring and Control** Clean cultivation will reduce the population of cranberry fruitworm within a field significantly, but insecticide treatments may still be needed to achieve satisfactory control of this pest. In New Jersey, university recommendations suggest making the first application when larval entries are first seen on the fruit, with a second application 7 to 12 days later in fields where the pest is a serious problem. Economic threshold levels have not been established.

Synthetic sex pheromones for the cranberry fruitworm have been under development for several years; monitoring the flight of adults with pheromone traps will greatly improve the timing of pesticide treatments for this pest.

### **Cherry Fruitworm** *Grapholitha packardii* Zeller Lepidoptera: Tortricidae

**Description and Life History** The cherry fruitworm can be a serious pest of highbush blueberries in New Jersey and North Carolina. It is not generally a problem in Michigan, and it has been found only in parts of Pierce and King counties in Washington. It also feeds on cherry, apple, rose, and hawthorn.

The cherry fruitworm is a moth with one generation per year. It overwinters as a mature larva, a smooth caterpillar about  $\frac{1}{2}$  inch long with a brown head and pinkish body. As temperatures begin to rise in early spring, it changes to a pupa and after about two weeks in this stage it emerges as an adult. Adult emergence may occur over a period as long as 35 days. The adult is a small dark-gray moth with chocolate-brown bands on the wings; it has a wingspan of about  $\frac{3}{8}$  inch. Mating and egg laying commence in a few days. Small



greenish-white pancake-like eggs are laid about the time of blossom drop on small developing berries and on leaves (photo 60). Eggs hatch a week later, and the larvae enter the berry, often in the calyx cup. The larvae feed within the berries and are well hidden. Young larvae are white with black heads; as they mature they become pink with brown heads. A larva may consume one to three berries; if it moves to another, it does not web the berries together like the cranberry fruitworm. Once feeding is complete, mature larvae leave the berries and choose a hibernation site, which may be a dead weed stem or a pruned stub in which they excavate burrows.

**Damage and Importance** Damage is usually not noticed until just before harvest; infested berries often turn blue prematurely. An early field inspection may reveal that only 2 to 5% of the berries have larvae in them, but 25 to 50 percent of the berries can actually be destroyed or rendered unmarketable by harvest.

**Monitoring and Control** Growers should begin examining fruit and leaves for eggs by mid-May. Economic threshold levels have not been determined for the cherry fruitworm. Two pesticide treatments are usually required for good control in fields with significant cherry fruitworm populations because of the long emergence period of the adults. The first treatment should be applied when larvae are first observed entering the fruit; the second is usually applied about 10 days later.

**Blueberry Maggot** *Rhagoletis mendax* Curran  
Diptera:Tephritidae

**Description and Life History** The blueberry maggot overwinters as a puparium, buried in the soil below the bushes. The puparium looks like a seed: it is brown or yellowish brown, somewhat barrel-shaped, and about 1/8 inch long. Emergence from the puparium is affected by many factors, including soil moisture, soil temperature, the depth of the puparium, and how much chilling the puparium received during the winter months. In regions with relatively mild winters, a puparium may lie dormant more than one year if a sufficient cooling period is not obtained in the first winter. This is often the case in New Jersey fields. Emergence usually begins in mid-June and continues through much of the summer.

The adult fly is slightly smaller than a housefly, with a black and dark-gray body and one pair of wings marked with distinctive black bands; the adult has a distinct white to cream-colored marking on its thorax and thin banding of the same color on the abdomen (photo 61). Adult females lay eggs about 7 to 10 days after they emerge. Eggs are usually inserted just under the skin of ripening or ripe berries, although some may oviposit in green fruit. Generally, only one egg will be laid per berry, apparently due to a marking pheromone produced by ovipositing females.

A tiny maggot hatches from the egg 2 to 7 days after oviposition. The maggot tunnels throughout the fruit, liquefying the flesh as it matures. Small larvae are colorless, making their detection almost impossible, but older larvae can be found inside berries due to their size, the whitish clouding of their bodies, and the destruction of the fruit flesh (photo 62). Infested fruits are soft and may bear a depression or hole at the point of egg insertion (photo 63). After about twenty days inside the fruit, the larvae drop to the ground to pupate.

At least two species of parasitic wasp in the family Braconidae attack the blueberry maggot in the eastern United States, sometimes causing up to 40% mortality. These wasps may soon become available commercially for use in biological control. Ants also provide natural control by their predation on larvae and pupae in the soil. Unfortunately, parasitism and predation do not have a great effect on maggot infestation, so pesticides are often needed to produce clean fruit.

**Damage and Importance** The blueberry maggot is generally the most serious pest of blueberry production in the eastern United States. Without pesticide treatments in some fields, nearly all of the berries may be infested, even in some otherwise well managed fields. This is especially true if commercial fields are near abandoned or wild blueberries. There is zero tolerance for blueberry maggots in berries sold for processing; one maggot detected by inspectors can result in the refusal of an entire shipment. When preserves are made from infested berries, the maggots rise to the top after processing and can be found just under the lid of the container.

**Monitoring and Control** Determining the onset of adult fly activity is essential to the control of blueberry maggot, as protective sprays must be applied before the 7- to 10-day pre-oviposition period ends. Adult flies can be trapped on yellow sticky boards; the catch will be enhanced if the boards are baited with protein hydrolysate and ammonium acetate. Commercially available yellow sticky board traps for apple maggot adults can be used effectively. Traps should be placed on the perimeter of commercial fields, or just outside of commercial fields in abandoned or wild blueberries if these are nearby. Blueberry maggot adults generally do not enter managed fields until some time after emerging in wild areas; adults may have already passed through their pre-oviposition period by the time they appear in commercial fields. Traps in nearby wild areas will provide a more timely indication of maggot activity. Once adult activity has been detected and the timing of the first protective spray determined, monitoring may be discontinued. Pesticide treatments must be continued on a regular schedule through the end of harvest in order to adequately protect the fruit from infestation by the blueberry maggot where this pest is a problem. Clean harvest and prompt picking may provide a small amount of control.

**Plum Curculio** *Conotrachelus nenuphar* Herbst  
Coleoptera:Curculionidae

**Description and Life History** The plum curculio is a well-known pest of many tree fruits that also infests blueberries. Its importance as a blueberry pest has been minor in recent years, but on occasion it appears in economically damaging levels in commercial fields. The adult insect is not frequently seen; it is a small weevil (approximately ½ inch) with a wrinkled surface, brown marked with gray, white, and black flecks. The mouthparts are located on the end of a prominent snout. The adults will play dead to avoid detection.

The oviposition wound on fruits made by a female plum curculio is unique and diagnostic (photo 64). This crescent-shaped scar persists on the fruit throughout the season.

The larva of the plum curculio is a legless white grub with a distinct brown head capsule; it is about ¼ inch long and somewhat C-shaped when full grown. It matures within a single fruit; the berry may fall from the bush before the grub matures. When full grown, the larva leaves the fruit and enters the ground to pupate. The pupa is white, about ½ inch long, and resembles the adult in form. New adults emerge from the soil from midsummer to fall, and overwinter under debris in fence rows and woodlot borders.

**Damage and Importance** The plum curculio is a concern mainly on early-ripening varieties, which might be harvested while the grubs are still within the berries. Curculio larvae in mid-to late-ripening varieties usually cause the damaged fruit to drop from the bush before harvest; there is some loss of yield but little threat of a contaminated harvest.

**Monitoring and Control** Adult plum curculio are rarely seen on the bushes. As soon as fruit set has begun, fields should be inspected for the characteristically shaped oviposition wounds. If these become numerous, prompt chemical control may be warranted in order to protect fruit from further oviposition. If treatments cannot be made immediately, curculio activity will not be significantly reduced. In some cases, it may be necessary to remove beehives from the field early in order to treat for plum curculio. Clean cultivation provides light to moderate control of plum curculio populations.

### **Green Fruitworms** Lepidoptera:Noctuidae

**Description and Life History** Several species of noctuid moth larvae fit the description of “green fruitworm.” The caterpillars are robust and active, about 1¼ inches long when mature. They are varying shades of green and usually bear a lighter colored lateral stripe and some small speckling of white or yellow (photo 65). Larvae feed on tender young leaves and blossoms early in the season; they are rarely seen on bushes after bloom. Most species pupate in the soil. Adults are brown to gray and mottled, similar to cutworm adults, with a wingspan of about 1½ inches. Different species of fruitworms overwinter as eggs, pupae, or adults.

**Damage and Importance** Green fruitworm abundance varies within fields and from site to site; when numerous, these robust larvae can consume many leaves and blossoms and injure developing berries. Populations can be reduced by clean culture or in-row weed control.

**Monitoring and Control** Growers should scout for green fruitworms on a regular basis from bud break through late bloom. A close inspection of shoots, especially blossom clusters, is the most accurate scouting method. They cling more tightly to the foliage than most other pests, so dislodging them onto a sheet is not a practical method.

The greatest feeding activity of green fruitworms usually occurs during bloom in New Jersey, making bacterial insecticides the most frequently chosen treatment. No economic threshold levels have been determined.

**Scarab Beetles** Japanese Beetle, *Popillia japonica* Newman  
False Japanese Beetle, *Strigoderma arboricola* Fabr.  
Rose Chafer, *Macrodactylus subspinosus* (Fabr.)  
Coleoptera: Scarabaeidae

**Description and Life History** Adults of these beetles are frequently found on the fruit and foliage of blueberry in the eastern United States. The Japanese beetle is a shiny deep green with dark brown wing covers, marked with a series of white spots along the sides of the abdomen (photo 66). The false Japanese beetle is very similar but generally darker in color, and lacks the white spots on the abdomen. The rose chafer is a more elongate beetle with gangly legs, reddish brown with dense, short dull-yellow hair that gives the insect a buff or fawn coloration (photo 67). All three of these beetles are usually  $\frac{3}{8}$  to  $\frac{1}{2}$  inch long.

**Damage and Importance** Adult scarab beetle feeding injury usually appears as skeletonized leaves or surface scarring of the fruit. Leaf feeding is a concern in blueberry fields only if populations are very high. Fruit feeding may cause significant direct damage to fruit quality and may allow fruit rot fungi a point of entry. These beetles are a significant problem during harvest when they are dislodged from the plant and contaminate the packed berries. These insects tend to be a greater problem in sodded fields, as the larvae of several scarab beetles prefer to feed on the roots of grasses (see pages 74–75).

**Monitoring and Control** These highly visible insects are easily spotted in the field. Specific economic thresholds have not been determined, but their threat to fruit quality and a contaminated harvest often call for control efforts. Adults are susceptible to several common pesticides, but timing is a critical factor. Maintaining clean culture will reduce but not eliminate scarab beetle problems, as they may fly into fields from great distances.

### **Yellow Jackets** *Vespula* sp.

Vespidae:Hymenoptera

**Description and Life History** Yellow jackets are small wasps (approximately  $\frac{1}{2}$  inch) with bold black and yellow markings on the head, thorax, and abdomen. They possess stingers and a venom which can be quite painful. The adult yellow jackets feed mainly on natural sugar sources but forage for protein-rich foods for their larvae; they are effective predators of caterpillars and other soft-bodied insects.

Yellow jackets are social insects that construct large paper nests in which thousands of individuals may live. The location of these nests varies by species and with the environmental conditions of the area. Some species prefer to nest in the ground or under the cover of brush piles, fallen trees, or manmade structures. The German yellow jacket, *Vespula germanica* (Fabr.), prefers to nest inside wall voids, attics, and other spaces in manmade structures. Other species prefer to hang their nests in trees.

**Damage and Importance** Adult yellow jackets can become a serious and painful nuisance when they feed on ripe blueberries. Large numbers of adults can significantly hamper the activities of workers in the field, especially during harvest. Mechanical harvesters knock yellow jackets into the berries, from which they will later emerge to endanger workers during the transport and packing of the fruit.

**Monitoring and Control** Yellow jackets are very difficult insects to predict or control. Prompt and clean harvest will reduce the attraction of these wasps to fields. Packing house areas should be carefully maintained to prevent nest building efforts of yellow jackets and to keep them from entering buildings through broken

windows, open doors, or gaps in weatherstripping. The use of commercial yellow jacket traps has not been successful in reducing problems with these insects.

**Carpenter Bee** *Xylocopa virginica* Linn.

Hymenoptera:Xylocopidae

**Description and Life History** Carpenter bees are large solitary bees that resemble bumblebees, with shiny black heads, yellow hairs on the thorax, and black abdomens with sparse black setae (photo 68). Adult carpenter bees bore cylindrical tunnels in solid wood for their nests.

**Damage and Importance** Carpenter bees are destructive foragers on blueberry blossoms; instead of pollinating, they sometimes bite through the corolla and take the nectar through the opening. The injured flower senesces rapidly and may become infected with botrytis. Injured flowers may still set and mature fruit.

**Control** There are no specific controls for carpenter bees. Growers should be sure to have enough beehives for the pollination period so that competition from honey bees will discourage carpenter bees from foraging in the fields.

## **Pests Infesting Leaves and Shoots**

**Leafrollers** Red-banded Leafroller, *Argyrotaenia velutinana* Walker

Fruittree Leafroller, *Archips argyrospilus* Walker

Oblique-banded Leafroller, *Choristoneura rosaceana* Harris

Lepidoptera:Tortricidae

**Description and Life History** These are the most common leafrollers on blueberry in the eastern United States; other species are occasionally found, but rarely at pest levels. All blueberry leafroller larvae construct a shelter from plant parts and silk. Early in the year several small terminal leaves may be used, resulting in distorted leaf and shoot growth. Flowers or green fruit may also be tied with silk for a shelter (photo 69); the larvae may destroy several flowers or feed on the surface of the berries (photo 70).

Red-banded leafroller larvae are shades of green with pale straw to greenish heads and thoracic shields, and reach a length of about  $\frac{5}{8}$  inch. Oblique-banded and fruittree leafroller larvae are sometimes difficult to distinguish; both are yellow-green to light green with darker colored heads and thoracic shields and grow to  $\frac{7}{8}$  to 1 inch. Oblique-banded larvae have light brown to blackish heads and black to light green thoracic shields (photo 71). Larvae of the fruittree leafroller tend to have dark brown to black heads with less pigmented thoracic shields (photo 72). Leafroller larvae often wriggle violently when disturbed or removed from their shelters. All three species usually pupate in their feeding shelters.

Adults of these species are easily distinguished. The red-banded leafroller is the smallest, with a wingspan of  $\frac{1}{2}$  inch. The wings are ornately marked with silver, gray and dull orange, featuring a prominent reddish-brown diagonal band on each forewing (photo 73). Adult oblique-banded leafrollers are marked with bands of tan and chocolate brown on the forewings (photo 74).

Fruittree leafroller forewings are rusty brown with gray shading; there are alternating patches of dark brown and silver gray along the forward margin of the wing (photo 75). Fruittree and oblique-banded leafroller adults are generally larger, with wingspans up to 1 inch.

The eggs of these leafrollers are laid in small, flat masses which may contain over 100 eggs each. The red-banded leafroller masses are small, pale yellow to cream colored, and placed on branches and stems early in the year; egg masses of later generations are usually deposited on the upper surfaces of leaves. Oblique-banded leafrollers lay eggs on leaves; they are dull greenish yellow masses about  $\frac{1}{4}$  by  $\frac{1}{2}$  inch in size. After hatching the masses are white (photo 76). Fruittree leafroller egg masses are oval, about  $\frac{1}{4}$  inch in length, and dark colored until hatched. They are usually laid on branches low in the bush (photo 77).

Red-banded leafrollers overwinter as pupae in cocoons on the soil surface or in the leaf litter; it has three generations per year. Oblique-banded leafrollers overwinter as second or third instar larvae in hibernacula on large branches or in the crown of the bush; they complete two generations each year. Fruittree leafrollers overwinter as eggs; they have only one generation per year.

**Damage and Importance** Leafrollers are a greater problem as a contaminant of harvested blueberries than as direct damagers of leaves and fruit. Occasionally the feeding injury to berries softens the fruit or allows fruit rot fungi to infect the berry at the feeding site. They are easily dislodged from their shelters by pickers or mechanical harvesters. The fruittree leafroller is generally not as serious a pest since it completes its single generation before harvest is underway.

**Monitoring and Control** Scouting for leafroller larvae should begin in the prebloom period. Adults of these species can be monitored with pheromone traps to help determine the proper timing of scouting for larvae and applying treatments of later generations. University recommendations from New Jersey call for treatments if there is greater than one redbanded leafroller larva per 100 leaf shoots. This threshold is often exceeded during bloom, necessitating the use of bacterial insecticides.

### **Orange Tortrix** *Argyrotaenia citrana* Fernald

Lepidoptera:Tortricidae

**Description and Life History** The orange tortrix is the most frequent leafroller pest on blueberries in the Northwest. It also feeds on cranberries and strawberries. The larvae of this moth feed on the tender leaves and buds as well as the berries, although direct damage to fruit is usually negligible. They are pests mainly as contaminants of harvested berries. The larvae wiggle vigorously and drop out of their shelters when disturbed.

Orange tortrix caterpillars are light cream to greenish in color with light brown heads and are about  $\frac{1}{2}$  inch long when fully developed. The moths are buff colored and have a wingspan of  $\frac{1}{2}$  to  $\frac{3}{4}$  inch. They overwinter as caterpillars in various stages of development, and have several overlapping generations each year. Larvae appear as early as March and are present well into the fall.

**Damage and Importance** When pickers or machines shake the plants, the disturbed larvae drop into containers, resulting in rejection by the processors.

**Monitoring and Control** Pheromone traps are used to monitor this pest in cane berries to determine if the moths are present and if they occur in significant numbers to more carefully and accurately time necessary applications. This practice can also be used in blueberry plantings. As with cane berries, applications should be made 2 to 3 weeks after flight peak or immediately when 70 or more moths have been caught per week in the traps. Placement and trap maintenance information can be provided by your county extension agent. See “Selecting and Monitoring Pheromone Traps in Insect Pest Management,” available from Oregon State University, for additional information and for the addresses of companies that sell specific pheromone traps. It should be pointed out that orange tortrix traps will also attract the oblique-banded leafroller from outside of the fields.

**Blueberry Leafminer** *Gracilaria vacciniella* Ely  
Lepidoptera:Gracillariidae

**Description and Life History** This species is the most common of several leafmining insects that infest blueberries, and the only one that forms a tentlike nest in later instars. The blueberry leafminer overwinters as full grown larvae inside tough white cocoons on the surface of the soil or in the leaf litter. Pupae are formed in the spring, with adult moths generally emerging in May. Young larvae feed like typical leafminers, between the two surfaces of a leaf; the mines are visible from the underside of the leaf (photo 78). In later stages, larvae leave their mines and use silk to fold and tie a single leaf into a symmetric, triangular tent; they then feed on the surface of the leaf inside this structure. This insect has been called the “tepee maker” due to this unique larval shelter (photo 79). Larvae leave the tents when mature and drop to the soil to form their cocoons, transform into pupae, and emerge as adults. Further generations are possible in warm years. A braconid wasp, *Apanteles ornigis*, occasionally causes high mortality of the leafminer in the cocoon stage in New Jersey.

**Damage and Importance** Blueberry bushes can tolerate high populations of this insect without significant loss of production, as it does not consume a great deal of leaf area. If the fruit is hand harvested this insect is usually not a problem as a contaminant in the berries, but if machine harvesting is employed, the tepees frequently fall from the bush with the berries. This increases sorting time and may result in a contaminated product.

**Monitoring and Control** There is no suitable monitoring method other than frequent visible inspection of the underside of leaves for the presence of mines. Be careful to count only mines with live larvae inside when scouting during later generations. Although no economic thresholds have been determined, it is known that much higher populations can be tolerated if the crop is to be hand harvested. Treatments are recommended when the first mines are seen for each generation.

**Sawflies** Hymenoptera:Tenthredinidae

**Description and Life History** Sawfly larvae are occasionally found feeding on blueberry leaves. They resemble caterpillars of Lepidoptera but have 8 pairs of fleshy prolegs instead of

5, and their heads and thoracic legs are more prominent than on most lepidopteran caterpillars. The sawfly larvae found on blueberries are usually less than 1 inch long when full grown (photo 80). Mature larvae pupate on or in the soil. Adult sawflies are wasplike but do not have constricted waists; most are dark colored but they may have some bright markings.

**Damage and Importance** Sawfly larvae have been found feeding on expanding buds, leaves and flower parts, but they rarely cause any significant damage. They are early-season insects, usually maturing and disappearing by mid-bloom. Growers frequently mistake sawfly larvae for the larvae of leafroller moths. The two groups differ in that sawfly larvae do not use silk to make a shelter out of plant parts.

**Monitoring and Control** Sawfly larvae are often detected while examining bushes for leafroller larvae. No particular controls are required. Clean cultivation greatly reduces their numbers.

**Other Leaf-Feeding Caterpillars** Fall Webworm, *Hyphantria cunea* Drury  
Lepidoptera:Arctiidae

Datana Worm, *Datana* sp.  
Lepidoptera:Notodontidae

Forest Tent Caterpillar, *Malacasoma disstria* Hbn.  
Lepidoptera:Lasiocampidae

Gypsy Moth, *Lymantria dispar* Linn.  
Lepidoptera:Lymantriidae

These are the most common of the many lepidopteran species that will feed on the foliage of blueberries. The fall webworm is a yellowish-brown larva with long, dense hairs. Many larvae live together in a messy silken shelter constructed around a portion of the bush. Datana worms are brightly colored and ornately shaped; they also feed in groups but do not produce silk nests (photo 81). The fall webworm and datana worm rarely appear until after harvest and may go untreated unless populations are very high. The forest tent caterpillar is dark brown to black with deep-blue markings and has a series of white or yellow dots down the midline of the back; tufts of fine brown hairs cover the body. These caterpillars feed in colonies when young but do not form tents with silk on blueberry bushes. Full-grown larvae may be 2 inches long. The gypsy moth larvae are dark brown to blackish with fine markings of light yellow or white; a series of paired, blue or red bumps runs down the length of the back. Gypsy moth larvae have long, stiff hairs arranged in tufts. Large larvae may be over 2 inches long. Tiny first-instar gypsy moth larvae are often blown into blueberry fields from nearby woodlots. Forest tent caterpillars and gypsy moths infest bushes early in the season, often during bloom. Bacterial insecticides are the only choice if these insects are numerous during bloom.



**Sharp-Nosed Leafhopper** *Scaphytopius magdalensis* Prov.  
Homoptera:Cicadellidae

**Description and Life History** The sharp-nosed leafhopper overwinters as an egg inside the tissues of fallen blueberry leaves (photo 82). Egg hatch begins in mid-May, and the insect has 5 sedentary nymphal instars (photo 83) before reaching adulthood in June or July. Adults are winged and are capable of dispersing great distances (photo 84). These adults deposit eggs in leaves which mature to a second generation of adults in late summer to early autumn. Adults then oviposit the overwintering eggs in leaves. Nymphs grow to approximately  $\frac{1}{16}$  inch; they are mottled brownish or brownish-black, often with a cream or white hourglass-shaped marking on the back. The adults are slightly larger and are uniformly dark brownish-black. Both the nymphs and adults have a sloped and pointed anterior projection of their heads. Several species of the genus *Scaphytopius* may be found infesting blueberry and other plants in and around the fields. These species are difficult to distinguish in the field.

**Damage and Importance** The sharp-nosed leafhopper and about 20 other species of leafhopper that infest blueberry cause no direct injury of any concern to the grower. However, the sharp-nosed leafhopper is a vector of the mycoplasma-like organism (MLO) which causes blueberry stunt disease (see pages 84–85). Recent studies have shown that two closely related species, *S. acutus* and *S. frontalis*, are also capable of vectoring stunt disease. Leafhoppers acquire the MLOs by feeding on infected bushes; if the adults fly to a healthy bush and feed there, they inject MLOs into the bush, spreading the disease. Blueberry stunt disease is a serious problem in eastern states where the sharp-nosed leafhopper is quite common; in Michigan stunt disease is a less serious problem and the sharp-nosed leafhopper is rarely numerous. The agitation and dispersal of leafhoppers by mechanical harvest equipment appears to have contributed to the spread of stunt in New Jersey.

**Monitoring and Control** The adult activity periods of sharp-nosed leafhoppers can be determined by trapping adults on yellow sticky boards, sweep-netting the foliage of wild or abandoned blueberries, or tracking the development of nymphs. Generally, pesticides made for other pests are applied at the right times to provide good leafhopper control. In fields where IPM methods have reduced the number of pesticide treatments made against fruitworm pests, sharp-nosed leafhoppers may become a more numerous and serious pest. In these fields specific treatments for leafhoppers may be required in order to limit the spread of blueberry stunt disease. Where stunt disease and leafhoppers are a serious threat, a postharvest spray to control the second generation of adults may be justified; in nurseries, a regular schedule of treatments may be needed from mid-May through mid-October to provide adequate protection to mother plants and nursery stock.

**Blueberry Aphids** *Illinoia pepperi* McGillivray  
Green Peach Aphid, *Myzus persicae* (Sulzer)  
*Fimbriaphis fimbriata*  
Homoptera:Aphididae

**Description and Life History** The primary aphid found on cultivated blueberries in the northeastern United States is *Illinoia pepperi*, a bright green, robust aphid which is most often found on the underside of new, succulent leaves and on actively growing shoot tips (photo 85). Large individuals may approach 1/8 inch in length. In Michigan, this aphid overwinters as eggs laid by wingless females very late in the season; females have been found as late as December. It is not known if adult aphids are able to overwinter in the warmer production regions. Eggs are laid on small sucker shoots and bud scales near the base of bushes. These hatch in the spring to small powder-green nymphs which move to fresh succulent leaves and shoots, where they mature to wingless “stem-mother” forms. These adults give birth to live young without mating, and their offspring all become females once they mature; some of these may have wings as adults. Several more generations of live-bearing females are produced each year, with populations reaching extreme levels in midseason. A combination of climatic and host plant factors generally reduce the aphid populations in the late summer and fall. Late in the year true males and egg-laying females appear in the population.

In the Northwest, the primary aphids are the green peach aphid, *Myzus persicae*, and *Fimbriaphis fimbriata*. The green peach aphid, which can be red or green, may deform leaves and devitalize many weeds or crop plants. *Fimbriaphis fimbriata* is found on blueberries more commonly than the green peach aphid. It is a small to moderate sized, yellowish green aphid which is also found on strawberries. The biology of this aphid is not well documented.

**Damage and Importance** *Illinoia pepperi* has been identified as the vector of shoestring disease, a serious problem in Michigan plantings (see pages 80–81). The aphid and disease are not as prevalent in other states.

It is strongly suspected that aphids are vectors of one of the blueberry scorch viruses in the Northwest (see pages 78–79). Transmission has not been scientifically demonstrated, but indirect evidence suggests that aphids are involved in the spread of this disease.

All blueberry aphids excrete honeydew, which becomes a sticky film on the leaves and berries. Black sooty mold may grow on the honeydew. Although aphids can be present and begin to build up before bloom, in many cases population buildup does not occur until after bloom. If virus diseases are not a serious threat, sprays may be avoided by allowing natural control agents, such as lacewings, ladybird beetles, syrphid flies, and parasitic wasps, to build up and provide significant population control. Unfortunately, lacewing or syrphid fly larvae may pupate in the calyx cup and become an insect contaminant of the harvest. Aphids are usually hard to find on wild bushes, and even when present they rarely build up to high populations.

**Monitoring and Control** A visual examination of the youngest leaves and succulent shoots will quickly reveal aphids if they are present in high numbers. Be sure to check low in the bush early in the season. What constitutes a tolerable population depends on many factors. If blueberry shoestring virus is a problem in the field or immediate area, *Illinoia pepperi* must be kept in check. Examine colonies for the presence of winged adults or nymphs with developing wing pads; these

aphids might carry the virus great distances within a field. Wingless *I. pepperi* do not move far from their point of origin and are unlikely to leave the bush on which they were born. However, machine harvesting will dislodge thousands of wingless aphids from the bushes to the ground, where they will immediately begin walking in search of a host bush. If they are infected with the virus, they might introduce it to a new bush in this manner. Growers with moderate to heavy populations of *I. pepperi* should consider a treatment to control aphids prior to mechanical harvesting.

**Blueberry Tip Borer** *Hendecaneura shawiana* Kearfott

Lepidoptera: Tortricidae

**Description and Life History** Adults of this small moth (wingspan about ½ inch) emerge in early June in the Northeast. They lay translucent, scalelike eggs, usually on leaves at the tips of succulent shoots, although they may oviposit on the leaves of older stems. After hatching the young larvae bore into the shoot a few inches down from the tip. Their feeding inside the stem causes it to wilt and turn purple; the leaves above this point may also become yellow with reddish veins (photo 86). These symptoms are sometimes mistaken for the primary infection of mummy berry disease or phomopsis twig blight (see pages 88–90). Larvae continue to feed until November, when they prepare a thin spot in the stem wall which will serve as an exit route for the mature moth the next spring.

**Damage and Importance** Left unchecked, this insect has been known to reach high populations and destroy up to half of the young shoots on bushes. This results in growth loss in the year of infestation and the loss of prime fruit-bearing wood in the following year. Secondary growth is often induced below the dieback, but this growth is weaker and makes the bush more dense due to excessive numbers of small stems. The tip borer is rarely seen in fields that are regularly treated for fruitworms.

**Monitoring and Control** It is important to become familiar with the differences in symptoms between the tip borer and mummy berry infections. The standard spray program used by most growers keeps this pest below damaging levels.

**Blueberry Stem Gall Wasp** *Hemadas nubilipennis* Ashmead

Hymenoptera: Pteromalidae

**Description and Life History** The adult blueberry stem gall wasp is a small (less than ⅛ inch) shiny black insect with delicate wings. It lays its eggs in succulent shoots. Several grublike larvae develop in closely associated chambers inside the shoot; the larvae release a chemical substance which induces the shoot to grow abnormally, resulting in a pithy, kidney-shaped gall ¾ to 1¼ inches long. Pupation occurs within the larval chambers; the new adults bore an exit hole through the gall. Early in the season galls are greenish and spongy to the touch. By fall the galls turn brownish-red and become quite hard (photo 87). Shoot growth is reduced and the shoot may be diverted at severe angles.

**Damage and Importance** Unchecked, the blueberry stem gall wasp can cause severe reductions in shoot growth and stem vigor. Hundreds of galls can develop on a single bush. Heavy infestations reduce fruit production and result in dense, stemmy growth. Susceptibility to galls may depend on variety. This insect is rarely

encountered in fields managed with standard chemical pesticide programs, but it can be a major pest of organically managed fields.

**Monitoring and Control** Chemical treatments directed toward other pests are generally sufficient to keep stem gall in check. Removal and destruction of galls during normal pruning operations will also control this pest.

## **Pests Infesting Stems, Canes, Crowns, and Roots**

**Putnam Scale** *Diaspidiotus ancyclus* Putnam  
Homoptera:Diaspididae

**Description and Life History** The visible part of a scale insect is actually a waxy covering produced by the maturing stages of the insect. Under this, the female feeds, mates, and lays eggs. The adult male is a tiny winged insect which emerges from the scale covering. Newly hatched nymphs are highly mobile and known as crawlers; as the crawler matures, it stops moving and settles down to feed. It then begins to form a waxy scale covering over its body.

Putnam scales are found mainly on older bushes, especially if pruning has not been regularly practiced to remove old canes; look for them under the loose bark on older wood. Putnam scales will also migrate to leaves and fruit. The scale looks like a gray waxy dot about  $\frac{1}{16}$  inch in diameter (photo 88); an immobile yellow insect can be seen if the scale covering is lifted away. In heavy populations, they may form encrustations that blend in with the color of the bark. On fruit, the scale appears to be surrounded by a circular red discoloration, degrading market value (photo 89). There may also be a slight dimple at the site of attachment.

The Putnam scale overwinters as a fully developed adult. Females lay eggs under their scales in the spring; crawlers start emerging in mid-May in New Jersey. Most of the crawlers settle on mature canes and stems, but some do so on leaves and fruit. They excrete honeydew, which drops onto leaves and fruit below the scales. Black sooty mold may grow on the honeydew, reducing the photosynthetic capability of leaves and rendering the fruit unmarketable.

**Damage and Importance** Putnam scale infestations cause a general loss of bush vigor, sooty mold on leaves, and blemished fruit. This scale is a much greater problem if fields are not frequently pruned.

**Monitoring and Control** Good pruning, removing the oldest canes each year, will greatly reduce Putnam scale infestations. Dormant oil sprays are also effective against the overwintering adult scales. Applications may also be directed at crawlers during their emergence period.

**Lecanium Scale** *Lecanium* sp.  
Homoptera:Coccidae

**Description and Life History** Lecanium scale is the major scale pest of blueberries in the Northwest. This scale attacks a wide variety of plants. When abundant, it can devitalize plants and retard growth. Mature females are reddish-brown and about  $\frac{1}{8}$  inch in diameter. Male scales are flat and appear grayish-white. Overwinter-

ing takes place as a partially developed nymph on twigs and branches. In the spring maturation resumes, and females deposit eggs under their scale covering. The crawlers which hatch from these eggs disperse to new feeding sites and begin producing new scales.

**Damage and Importance** Infestations cause a decline in bush vigor and sooty mold on the leaves. Honeydew on the fruit can be quite objectionable.

**Monitoring and Control** The time of crawler emergence from the eggs can be determined with a 10X hand lens. Examine fields periodically, beginning in early to mid-June. Inspect by gently turning over a few adult female scales to see the eggs beneath, or by wrapping clear double-stick tape around scale-infested twigs above live female scales. Begin pesticide application as soon as the small white crawlers are visible on twigs or the tapes.

Control requires thorough coverage with a drenching spray. Delayed-dormant oil sprays with a superior type oil are often effective. They are applied in the early spring, while plants are dormant and temperatures above freezing, to reduce the chance of phytotoxicity. Later spring and early summer insecticide applications are used to control the crawler stage of the scale. Once the formation of the waxy scale material begins these sprays are ineffective.

**Terrapin Scale** *Lecanium nigrofasciatum* Pergrande  
Homoptera:Coccidae

**Description and Life History** The terrapin scale is a dark brown, hemispherical scale about  $\frac{1}{7}$  inch in diameter (photo 90). They are found mainly on twigs, where they can reproduce quite rapidly. Hundreds of eggs may be produced by each female; the eggs remain under the female scale until they hatch into crawlers. The varieties Concord and Rancocas are especially susceptible.

**Damage and Importance** These scales can greatly reduce the vigor of the twigs they feed on. In addition, terrapin scales often produce a large amount of honeydew which can lead to the development of black sooty mold.

**Monitoring and Control** Good pruning can often keep terrapin scale in check without the use of pesticides. If chemical controls are needed, dormant oil sprays are effective. The crawler stage may also be monitored and treated with insecticides.

**Dogwood Borer** *Synanthedon scitula* Harris  
Lepidoptera:Sesiidae

**Description and Life History** The dogwood borer adult is a small moth (about  $\frac{3}{4}$  inch), mostly black with thin yellow bands on the abdomen; the wings have large clear areas with black scaling along the major veins. Adults lay eggs singly, generally within 8 inches of the ground, during the months of June and July. Newly hatched larvae bore under the bark at pruning scars, mechanical injuries, or at the junction of 2- and 3-year-old wood on canes. Larvae are white to light pink with deep-brown heads, and small abdominal prolegs. Larvae reach a length of about  $\frac{1}{2}$  inch by the fall. Larval feeding is usually shallow, just under the bark of stems, canes or the crown of bushes; it kills stems and severely weakens canes. The dogwood borer overwinters as a full-grown larva under the bark. Pupation occurs in May, with adults emerging about 25 days later.

The empty pupal case often protrudes through the exit hole made by the emerging adult.

**Damage and Importance** The dogwood borer has been a sporadic pest of highbush blueberries in Michigan since the 1960s. It has shown a preference for Berkeley, Weymouth, Jersey, Pemberton, Coville, Burlington, and Stanley. When present in high numbers it can cause significant losses by weakening canes that are broken by heavy crops, wind, or mechanical harvesters.

**Monitoring and Control** Adult presence and flight period can be monitored with pheromone traps placed within the field. Pruning out weak or less vigorous canes provides partial control. Although no pesticides are registered specifically for use against the dogwood borer, treatments made against other pests will provide some control if the spray is directed to the canes and crown of the bush. The level of control obtained will depend greatly on the timing of the spray; young larvae, not yet well protected under the bark, will be easiest to kill.

**Blueberry Stem Borer** *Oberea myops* Hald.  
Coleoptera: Cerambycidae

**Description and Life History** The adult blueberry stem borer is a thin, parallel-sided beetle with long antennae, about  $\frac{1}{2}$  to  $\frac{5}{8}$  inch long. The adult girdles small stems near the tip and lays an egg under the bark during late June or July. A fleshy, legless grub hatches from the egg and begins to tunnel in the stem (photo 91). During its 3-year development, the larva tunnels down the stem, and continues in a cane, often coming back up another cane after reaching the crown in the third year. It bores small holes to the outside of the cane through which it expels its sawdust-like frass. It pupates inside the larval tunnel.

**Damage and Importance** Tunneling in canes reduces vigor and severely weakens the structure of the plant. This insect is not a frequent pest in well-pruned fields.

**Monitoring and Control** Weak growth, flimsy canes, and holes emitting sawdust make this insect easy to detect. Pruning out infested canes provides adequate control; few infested canes will remain after normal pruning.

**Root Weevils** Coleoptera: Curculionidae

**Description and Life History** Root weevils are significant pests of blueberries in the Northwest, and occasionally damaging in the eastern growing regions, especially in nursery plantings (photo 92). Five species are common problems, although the strawberry root weevil, *Otiiorhynchus ovatus* Linn., rough strawberry root weevil, *O. rugostriatus*, and the black vine weevil, *O. sulcatus* Fabr., are the most economically important species.

Adult strawberry root, rough strawberry root, and black vine weevils are about  $\frac{1}{5}$ ,  $\frac{1}{4}$ , and  $\frac{1}{3}$  inch long, respectively. They are usually black but some specimens may be light to dark brown. The black vine weevil often has a few yellow or orange flecks on its back. The other two species are uniformly colored with no distinguishing marks. The larvae of these species feed on roots and are similar except in size. They are legless, C-shaped grubs with white bodies and brown heads (photo 93). The pupa, about the same size as the adult, is white to yellow. It is soft and looks similar to the adult weevil.

The life histories are the same for all three species. The weevil overwinters as a grub in the soil, feeding on plant roots whenever the soil temperature is high enough to allow activity. In April or May, the grub changes to a non-feeding pupa. Further transformation to the adult occurs in late May or through June. All adults are females capable of laying eggs without fertilization. They feed on plant foliage and begin to lay eggs on the surface of the soil three to four weeks after emergence.

**Damage and Importance** The injury to roots can severely weaken bushes in the field; infestations in nursery plantings can quickly kill newly rooted cuttings and young plants. The leaves of infested plants often redden prematurely. Feeding injury on leaves is minimal.

**Monitoring and Control** Examining fields for plants with reduced vigor or early-reddened leaves may help reveal root weevil infestations. The crown and larger roots must be examined in order to verify the presence of these insects, as other factors may cause similar symptoms. In most states there are no pesticides registered for use against root weevil grubs on blueberries. There has been some use of insect-parasitic nematodes against these pests in the Northwest, but the effectiveness of this approach has not been determined.

### **White Grubs**

Japanese Beetle, *Popillia japonica* Newman  
Rose Chafer, *Macrodactylus subspinosus* Fabr.  
Asiatic Garden Beetle, *Maladera castanea* Arrow  
May Beetles, *Phyllophaga* spp.  
Northern Masked Chafer, *Cyclocephala borealis* Arrow  
European Chafer, *Rhizotrogus majalis* Razoumowsky  
Oriental Beetle, *Anomala orientalis* Waterhouse  
Possibly other species

**Description and Life History** There are likely to be regional differences in the white grub species complex that can be found in blueberry fields. The species listed here have all been found in New Jersey plantings. The larvae are generally white or cream colored with brown heads and legs, and they hold their bodies in a distinct hooked or C shape (photo 94). Stretched out, larger species may be over one inch in length. Many of the species can be determined as larvae by distinctive patterns of stiff hairs on the undersurface of the tip of the abdomen (referred to as a “raster” by white grub authorities). Some species feed on the roots of plants for more than one year before completing development. Most species overwinter as grubs deep in the soil. Pupae are white to cream colored and have many features of the adult insect. The time of pupation and the emergence of adults varies with species.

Adults of white grubs are known generically as May beetles, June bugs, chafers, or scarab beetles. The adults of most species feed on the foliage, flowers and fruits of many plants. Japanese beetle and rose chafer adults can be significant pests of blueberry during harvest when they contaminate the berries (see pages 62–63).

*Damage and Importance* For many years white grubs were a rare problem in blueberry fields, but recently they have become serious pests in some fields, with populations as high as 30 grubs per bush. The grubs consume feeder roots and may also girdle or clip off larger roots. Infested plants may not show any outward signs of injury until a period of drought stress, when the reduced root system cannot provide enough water to the plant. Damaged bushes show low vigor and reduced production. It has been suggested that the recent increase in grub infestations has occurred because the long-residual chlorinated hydrocarbon insecticides that were formerly used on blueberries have finally been depleted from the soil under the bushes. Adults, especially the Japanese beetle and rose chafer, sometimes become serious pests by consuming leaves and scarring the berries.

*Monitoring and Control* Unfortunately, sampling for white grubs damages the roots of blueberry bushes. Growers should check new sites for white grubs before establishing a field, and take actions against grubs before planting. Currently, there are no insecticides registered for soil application against white grubs on blueberries. There is great interest in the use of pathogenic nematodes as biological control agents for the grubs. Adults are generally easy to control with foliar sprays, but timing is difficult since these are highly mobile insects that may suddenly appear in fields.

## ***For More Information***

---

*Selecting and Monitoring Pheromone Traps in Insect Pest Management.* EC1207. Available from Oregon State University Cooperative Extension, Corvallis, OR 97331.



## Chapter 9

# NEMATODE AND DISEASE MANAGEMENT

---

Many pathogens can affect the blueberry plant, but in general, diseases cause fewer problems with blueberries than with many other horticultural crops. Disease problems are most severe in older plantings, in areas with large concentrations of blueberry farms, or in locations where plants regularly experience environmental stress.

Three major types of organisms cause disease in blueberry plants: nematodes, viruses, and fungi. Consult the key to blueberry problems for help with identifying the cause of a disorder.

## Nematodes

---

Nematodes are unsegmented roundworms that are found in nearly every habitat on earth. Some species are free-living in soil, freshwater or marine systems, while others are parasites of plants or animals, including man. Free-living species and insect parasites may be beneficial, but plant and animal parasites are often serious pests. Nearly 3,000 species have been described as parasites of plants.

The dominant plant-parasitic nematodes found on blueberry plants include root-lesion (*Pratylenchus* spp.), dagger (*Xiphinema* spp.) and stubby-root (*Paratrichodorus* spp.). Adult root-lesion nematodes are  $\frac{1}{50}$  inch long; dagger nematodes,  $\frac{1}{100}$  inch long; and stubby-root nematodes,  $\frac{1}{25}$  inch long; they are rarely visible without magnification. Special laboratory procedures are required to isolate nematodes from soil or roots, and identifications must be made by trained professionals. Contact your Cooperative Extension System for information.

### Nematode Damage

All plant parasites feed by puncturing plant cells with their stylets (a structure resembling a hollow needle) and sucking out the material within the plant cell. Dagger and stubby-root nematodes feed as ectoparasites with their bodies remaining outside the root and only their stylets penetrating into the cells of the roots. Dagger nematodes may cause damage directly to roots if present in high numbers, but are most important as vectors for the tomato ringspot virus (see pages 82–83). Small populations of these nematodes can cause serious loss where the virus is present, spreading it from plant to plant or from infected weeds to blueberry plants. Stubby-root nematodes have been demonstrated to seriously damage blueberry cuttings by stunting the root system (photo 95). Although damage to healthy, established blueberry plants has not been documented, nematodes can stunt the growth of young blueberry plants. Larger plants may be susceptible to damage if stressed by other factors that limit root growth, such as a soil-borne pathogen.

Root-lesion nematodes feed as migratory endoparasites. Throughout their lives, they migrate into, through, and out of roots, feeding on some root cells and damaging others by tunneling through them. Eggs may be laid in the soil or in roots where juveniles begin feeding as soon as they hatch. This exten-

sive damage produces necrotic lesions, reducing the ability of roots to take up water and nutrients and increasing the susceptibility of roots to attack by soil-borne pathogens.

### **Nematode Control**

Given the damage nematodes can do to the potential vigor and life of a planting, it is important to submit a soil sample for nematode analysis several months before establishing a blueberry planting. Older blueberry plants which are vigorous and have extensive root systems may be able to tolerate nematode feeding which could stunt a young plant with a small root system. For this reason, soil (and root) samples should be submitted for nematode analysis long enough before the proposed planting date to allow time for preplant fumigation or other preplant control options such as fallowing.

In general, sandy, warm, dry soils support higher levels of nematodes than heavier, colder, wetter soils. Cropping history also has a major influence on nematode levels.

Little information is available on the levels of nematodes that cause economic damage to blueberry plantings. The levels are likely to differ depending on plant age, variety, and soil type. Recommendations will be based on experience with other crops.

Fumigation is a commonly used method for nematode control. The best time for preplant soil fumigation is August through mid-October. In early spring, soils are often too cold (below 50°F) and wet to allow for field operations or optimal effectiveness of chemical fumigants. The use of some fumigants requires a waiting period before planting. Regulations on fumigation vary widely, as they can be environmental hazards in regions where they are used extensively. Consult your local extension office for information on fumigation in your region.

Growers who wish to avoid chemical fumigants may wish to consider fallowing the land for one year and then getting a second nematode count at the end of the fallow period. Fallowing is generally considered to be an effective way to reduce nematode numbers; however, it is possible that populations may still be too high at the end of that year. Because several cultivated plant and weed species serve as good hosts for dagger and root-lesion nematodes, weeds must be diligently controlled during the fallow year.

Certain cover crops, including rye, ryegrass, sudangrass, and marigold, are also known to reduce nematode numbers. These can be seeded the year before planting blueberries to reduce nematode numbers. Mulched plots tend to have fewer nematodes.

The timing required for all of these operations must be taken into consideration when planning a new blueberry planting. However, the first step is collecting and submitting the soil sample. If nematode populations are low, no control measures will be required and planting can proceed.

### **Soil Sampling Procedures**

It is important to understand that nematode populations fluctuate throughout the year, and this will affect population density at various sampling times. Preliminary studies indicate that root-lesion nematode populations peak in July and dagger nematode populations peak in May. The best time, then, to

collect a soil sample would be during June and July. Samples collected at other times of the year may give readings that are low compared to what the populations will be in summer.

Root-lesion nematodes may be found in both soil and roots; therefore, it is recommended to submit both soil and root samples. The best way to collect soil samples is with a soil probe; contact your local Soil Conservation Service office for a soil probe. Each probeful of soil constitutes one subsample.

Although there is no set rule on the number of subsamples to take in a given area, several subsamples will result in a more representative and accurate sample. For this reason, it is generally recommended to collect at least 20 subsamples for every 1 to 5 acres. The subsamples should be drawn from sites chosen randomly throughout the field and then mixed together in a clean bucket.

Preliminary research indicates that only a few nematodes are found in the upper 3 inches of the soil, or in the sawdust mulch. Therefore, it is advisable to insert the soil probe to a depth of 12 to 15 inches and remove the top 3 inches of soil before dropping the subsample into the bucket. Once subsamples have been collected, mix the soil together and fill a quart-size plastic bag.

Roots should be collected with a shovel from several locations in the area to be sampled. Enough roots to fill a quart bag is adequate. Because high temperatures will kill nematodes, it is important to keep the sample in a cool shaded spot or in a refrigerator until sending it to a laboratory. Samples should be sent for analysis as soon as possible.

## ***Virus and Virus-Like Diseases***

---

There are a number of virus and virus-like diseases that are economically important in blueberry. These diseases are, in most cases, spread by an active biological vector, e.g. aphids, leafhoppers, nematodes, or honey bees that spread virus-infected pollen.

Once a bush is infected with a virus or virus-like disease, it is infected forever. A virus disease is not like a controllable fungal disease that may be present in one season but not the next. The best remedy for virus and virus-like diseases is prevention. Prevention begins with planting virus-tested clean stock in clean soil. If infection occurs in a field, then the next line of defense is roguing or removal and some form of vector control, usually with an insecticide, or in the case of a nematode-spread virus, with a nematocide.

### ***Blueberry Scorch Virus (BBScV)***

Blueberry scorch virus can cause severe flower and leaf necrosis in highbush blueberry. The virus is a member of the carlavirus group of plant viruses. It has been reported in Washington and Oregon, and all varieties of highbush blueberry are considered susceptible to the virus. The varieties Bluecrop, Bluetta, Concord, Jersey, Olympia, Washington, and U-154 are tolerant in that, when infected, they remain symptomless and do not suffer any significant yield loss. The varieties Pemberton, Berkeley and Dixi exhibit the most severe symptoms. The reaction to this virus in other varieties is not known.

**Symptoms** The disease was first observed on Berkeley in 1980. The symptoms of blueberry scorch first appear in late April to early May during bloom. Symptoms in some varieties consist primarily of a blossom blight with a few necrotic leaves near the blighted flower clusters and some marginal chlorosis of leaves produced on older wood (Pemberton and Dixi fit this category). Affected bushes develop symptoms every year. In Pemberton and Dixi the twigs with blighted blossoms and leaves often die back 2 to 4 inches. Berkeley plants are affected most severely in that they show extensive leaf necrosis and the plants can be killed in 3 to 6 years. Other varieties remain symptomless or only exhibit the chlorosis on leaves on older wood. The blighted blossoms often are retained throughout the summer but fail to develop into fruit (photos 96–97).

**Disease Spread** Blueberry scorch can spread rapidly in the field. In a block of 283 Pemberton blueberry plants the number of infected plants doubled annually until about 50% of the plants were infected. In this field, 6% of the plants were infected in 1983 and by 1988, 95% of the plants were infected. Since the disease is caused by a carlavirus, spread is most likely by aphids.

**Control** The best method of control is to plant virus-free stock. The spread of virus has only been recorded over short distances. If there is no known blueberry scorch in close proximity to a grower's field, scorch should not become a problem. The major problem comes when a neighbor has tolerant varieties that are infected with BBScV, as this will be a perennial source of inoculum. If an infection is observed early when only a few plants are showing symptoms, then an aphid control program combined with removing and burning diseased bushes over a 3-year period should prevent further spread of this virus. If part of the field is planted with a tolerant variety, then serological testing must be done to determine if and how far the virus has spread into that variety.

**Blueberry Shock  
Iilarvirus (BSIV)** Blueberry shock ilarvirus can cause a severe flower and leaf necrosis in highbush blueberry. It has been reported in Washington and Oregon. All varieties of highbush blueberry are considered susceptible to the virus. Bluechip and Spartan are tolerant in that, when infected, they remain symptomless and do not suffer any significant yield loss. Berkeley, Bluecrop, Bluejay, Blueray, Bluetta, Collins, Darrow, Earliblue, Elliott, Jersey, Patriot, and Weymouth exhibit symptoms. The reaction to this virus in other varieties is unknown.

**Symptoms** The disease was initially confused with blueberry scorch as the symptoms are similar. Serological tests for BBScV show that some bushes that tested negative for BBScV exhibited scorch-like symptoms. Bushes infected with BSIV develop a shock reaction; bushes exhibit symptoms for 1 to 4 years, then recover. That is, the bushes no longer show symptoms; however, these bushes are still infected with the virus and can serve as a source of inoculum.

The symptoms of blueberry shock first appear in late April to early May during bloom. With BSIV infections the blighted flowers do not persist as they do with BBScV infections. The bushes produce a second flush of leaves and by late summer look normal, but have little or no fruit. In some cases leaves that do not blight develop thin red ringspots that are visible on both

the upper and lower surfaces of the leaf blade (photos 98–100). This contrasts with red ringspot disease (see page 83) in which the red ringspots are visible only on the upper surface of the leaf.

**Disease Spread** Blueberry shock virus can spread rapidly in the field. Most ilarviruses, like BSIV, are most likely transmitted by pollen. This virus moves much more rapidly than other members of the group. The increased movement may be due to the shape of the blueberry flower, as the bees probably do considerable damage to the flower during pollen and nectar collection, allowing the virus access to the plant's vascular system. In fields that have been mapped, the disease appears to spread out radially from a center of infection. The virus spread occurs most rapidly in Berkeley; this may be due to the variety being highly susceptible to the virus or due to some slight flower alteration that favors transmission.

**Control** The best method of control is to plant virus-free stock. The spread of the virus in a field has been recorded only over short distances, so if there is no known source of BSIV nearby, a grower's field should not become infected. What may put a field at risk is a neighboring field in which the disease has run its course; the infected but recovered bushes serve as a source of inoculum. Blueberry shock is probably pollen-borne; growers should be careful not to bring beehives from fields that may be infected. This has been a means of spread for a related virus in cherry.

Results of current research may show whether an infection that occurs during bloom can be detected before bloom the following year. If so, then infected bushes can probably be removed before they become sources of inoculum. If not, then genetically engineered resistance may be developed for this disease.

**Sheep Pen Hill Disease (SPHD)** SPHD, similar to blueberry scorch, can cause serious yield losses where it occurs, but has been reported only in limited areas of New Jersey. Variety reaction to SPHD is variable, but no variety has shown complete resistance.

**Symptoms** The first distinctive symptoms appear at bloom. Flowers do not fill out normally, remaining small and unopened (photo 101). This is followed by flower and twig necrosis, then wilting of new vegetative shoots within 10 days after bloom (photo 102). This blighted condition persists into June when a second flush of growth occurs (photo 103). Little or no fruit will ripen, although other symptoms will be masked later in the season. A carlavirus has been associated with SPHD, but disease development is also strongly influenced by environment, especially prolonged wetness during the dormant season.

**Disease Spread** The agent spreading the virus has not been identified. Surveys indicate a random pattern of spread which is active and variable from year to year.

**Control** Use clean plant material when propagating. Remove diseased plants from established fields to reduce spread.

**Shoestring Disease** This is probably the most well-known virus disease, occurring primarily in Michigan and New Jersey. It has been seen in North Carolina and Washington, but is not important in these two states. In Michigan, bush and yield losses were over \$3 million in 1981.

**Symptoms** The most prominent symptom consists of elongated reddish streaks about  $\frac{1}{8}$  by  $\frac{1}{2}$  to  $\frac{3}{4}$  inch on current-year and 1-year-old stems, especially on the side exposed to the sun. During blossoming, the flowers on infected bushes will exhibit pinkish to reddish petals (Blueray naturally has reddish petals). Infected leaves are often straplike (hence the name shoestring). Many leaves on a bush may appear this way, although in some cases just a few clumps near the crown will show this symptom. A few leaves may show red vein-banding or reddish streaking along the midrib of the leaf. In some cases, an “oak leaf” pattern will show on the leaf blade. Other leaves may be crescent-shaped and partially or totally reddened. Infected stems may appear crooked, especially the tip-end half (photos 104–107).

**Disease Spread** Shoestring disease spreads “down the row.” In other words, the spread is bush-to-bush. The reason for this is that the virus is spread by the blueberry aphid *Illinoia pepperi* (see pages 68–70). The aphid picks up the virus as it feeds on an infected bush and then when it moves to the next bush in the row (usually the bushes are touching in the row) to feed, it passes the virus to the next bush. There is a 4-year latent period, i.e. it takes 4 years from the time of first infection to the expression of symptoms. Shoestring infected wild blueberries have also been found in the wooded areas surrounding commercial plantings.

Diseased propagation wood has been an important factor in the spread of shoestring disease from one field to another.

**Control** In fields where infected bushes are present, the use of aphicides is the best control. The first insecticide application should begin when the first aphids appear on the terminals of the stems, usually by late May to early June. Two or three sprays may be required throughout the growing season to keep aphid levels low. Infected bushes should be killed or removed. Growers who use mechanical harvesters must wash them to remove aphids; it has been shown that aphids are carried from a source bush to bushes 60 or more spaces down the row.

Shoestring disease has been seen in the field in Jersey, Rubel, and Blueray. Elliott and Spartan have been susceptible in experiments. In the field, Bluecrop seems to be resistant.

**Leaf Mottle Disease** Blueberry leaf mottle disease is currently found only in Michigan, but it could appear in other states at any time. This disease is potentially devastating because it is caused by a pollen-borne virus spread by honey bees; controlling the disease may mean reducing pollination. Within a few years after the onset of symptoms, leaf mottle disease kills back the stems of the bush and greatly reduces the bearing surface. Eventually the bush dies.

**Symptoms** Rubel shows the most severe symptoms. Bushes that have been infected for 5 or 6 years develop a severe dieback of older stems, leaving only stunted and deformed new growth emanating from the crown area. Leaves show a mottling pattern with sometimes chlorotic, roughly circular windows that are apparent if the leaf is held up to light. In the most severe cases, leaf malformations and leaf strapping occur. On Jersey, symptoms are much milder; stem dieback is less prevalent, as are stunting and growth reduction. The

terminal leaves, especially in the crown area, are rosetted due to the shortening of internodes. The color of these rosetted terminals is a yellowish pale green. In general, leaves on infected bushes are smaller than normal (photos 108–109).

**Disease Spread** Leaf mottle spreads through virus-infected pollen which is moved by honey bees. Honey bees and hives are an integral part of blueberry culture, but they carry virus-infected pollen in their pollen sacs. Also, bees transfer virus-infected pollen from one individual to another in the hive. Honey bees have been tagged at a hive and found in other hives 660 yards away. Also, tagged honey bees from a given hive have been observed foraging in blueberries up to a mile away from the hive. A hive with blueberry leaf mottle virus-infected pollen in it for up to 10 days resulted in healthy plants becoming infected after being placed in a cage with the hive and bees. One commercial field of about 20 acres in Michigan went from a few bushes infected to more than 50% of the bushes infected in less than 10 years.

Diseased propagation wood could be a second factor in the spread of the disease from one planting to another.

**Control** The best control is to kill and remove all infected bushes in the field. Because the symptoms of the disease are not always distinct, and because the first symptoms do not show for 4 years after infection, the only way to identify infected bushes is through an immunological ELISA test. Proper sampling is important; at least 6 samples should be taken from various places on the bush. Leaves (the more succulent the better) or dormant fruit buds are the best sources for samples. ELISA test kits are available through Agdia Co., Elkhart, Indiana.

The placement of beehives is important. If, for example, a grower's field does not have the disease, but a neighbor's does, the grower should place hives as far as possible from the neighbor's field. If a grower has one block with disease and another nearby block without disease, again, the placement of hives should be such that the distance between the virus source in one block is the furthest possible from the hives in the other block. Hives should be used only once in a field during the blossom season.

**Necrotic Ringspot Disease and Tomato Ringspot Virus Disease** These diseases will be discussed together because of the similarity of their symptoms. Both are vectored by the dagger nematode *Xiphinema americanum*. Necrotic ringspot disease, caused by tobacco ringspot virus, is by far the more important of the two diseases in terms of frequency. Both of these diseases cause a general decline of the bush.

Necrotic ringspot disease has been reported in Arkansas, Connecticut, Oregon, Illinois, Michigan, and New Jersey. This disease is common in the varieties Pemberton, Stanley, Rubel, Concord, Collins, and Earliblue. Tomato ringspot virus disease has been reported in Michigan, Oregon, Pennsylvania and Washington. In the field, it has been observed in Earliblue. Both causal viruses are very common in fruit crops and in woody ornamental plants. In addition, both viruses are found in many weeds that occur in fruit plantings.

**Symptoms** Necrotic ringspot disease: Varieties such as Pemberton and Earliblue exhibit stem dieback and bush stunting. Leaves are deformed and somewhat thick-

ened. Leaves may become chlorotic and show necrotic spots  $\frac{1}{16}$  to  $\frac{1}{8}$  inch in diameter. These spots may fall out, leaving a shothole effect. On other susceptible varieties (for example, Concord and Stanley), symptoms are usually expressed as short internodes on stem terminals and small straplike leaves. The twigs may show brownish, necrotic spots  $\frac{1}{16}$  to  $\frac{1}{8}$  inch in diameter. Fruit production is often greatly reduced (photos 110–111).

Tomato ringspot virus disease: In Earliblue, leaves are often malformed and have circular chlorotic spots on them,  $\frac{1}{16}$  to  $\frac{1}{8}$  inch in diameter. In addition, stems, twigs, and branches may exhibit circular, brownish necrotic spots of similar size. Younger terminal leaves tend to be strap-shaped and have a mottle pattern (alternating yellowish-greenish stippling). Fruit production may be reduced (photo 112).

**Disease Spread** Spread is by the dagger nematode *Xiphinema americanum* and through diseased propagation wood. One of the indications that the disease is spread by the dagger nematode is that symptoms spread slowly in a circular pattern at about 3 feet per year in all directions.

**Control** The best control for these diseases is prevention. Take soil samples before planting and have the soil tested for the presence of dagger nematode (see pages 76–78). If any are present, then preplant soil fumigation should be undertaken. Fumigate with a shank-type soil injection rig and a liquid fumigant. Plant only virus-tested clean stock plants.

If infection is found in an established field, control becomes more complicated. Infected bushes must be identified by inspection and by ELISA tests (Agdia kits can be used). Once the areas of infection have been identified in a field, remove all infected bushes along with major roots and the crown. Thoroughly fumigate the soil with a liquid fumigant. After a two-week aeration period, replant with virus-tested clean stock.

**Red Ringspot Disease** Red ringspot is the most important virus disease in New Jersey. It is also present in Arkansas, Connecticut, Massachusetts, Michigan, New York, North Carolina, and Oregon. Under Michigan conditions, up to a 25% crop loss was measured when 10 healthy bushes were compared with 10 diseased bushes in the same planting. The varieties that most commonly show symptoms are Blueray, Bluetta, Burlington, Cabot, Coville, Darrow, Earliblue, and Rubel. Jersey and Bluecrop seem to be resistant or immune.

**Symptoms** Stems at least 1 year old often exhibit reddish-brown spots with green centers (photo 115). The spots,  $\frac{1}{8}$  to  $\frac{1}{4}$  inch in diameter, also develop on the upper surfaces of older leaves in mid- to late summer. The powdery mildew fungus can cause similar symptoms on both sides of the leaf (see page 93 and photo 135). Rancocas may have circular light areas of blotching on the fruit. Bluetta sometimes shows a red ringspot-like disorder typified by red leaf spotting, which is probably caused by a genetic disorder. There are no ringspots on the stems associated with the genetic problem (photos 113–115).

**Disease Spread** Circumstantial evidence points to the mealybug (*Dysmicoccus* spp.) as a vector in the spread of this disease. Other vectors may be involved as well. Virus-infected propagation stock is a means of introducing this disease into a new planting.



**Control** Because the vector is not known for sure at this time, the main form of control is prevention, by planting virus-tested clean planting stock. If diseased plants are seen in a planting, they should be rogued out and destroyed.

**Mosaic Disease** Mosaic disease was earlier thought to be a genetically caused variegation disorder. In 1957, it was shown to be of virus or virus-like origin. This disease has been observed in plantings of highbush blueberry throughout the eastern United States, Michigan, Indiana, Oregon, Washington, and British Columbia.

The disease has been observed on older varieties of highbush blueberry, such as Cabot, Concord, Earliblue, Pioneer, Rubel, and Stanley. Typically, mosaic symptoms may appear on a few basal shoots only (photo 116). In some cases, the whole bush may show symptoms.

A different-looking mosaic disorder, found on Coville, may indeed be a genetic disorder (photo 117).

Yield data taken in Michigan on 10 healthy and 10 diseased bushes of Bluecrop in the same planting indicated a 15% crop loss due to the disease. Electron microscopy of ultrathin sections from diseased and healthy tissues has revealed packets of long rod-shaped virus-like particles in cells of diseased, symptomatic leaves.

**Symptoms** Symptoms include mild to brilliant mottle and mosaic patterns of chrome yellow, yellow, and yellow-green on leaves. Sometimes the leaves will also have areas of pink. The distribution of symptoms on a bush can be spotty or ephemeral, showing in a given year and not showing the next year, and then reappearing a year later. On Coville, the mosaic pattern is less brilliant. Rather than a bright yellow mosaic, the pattern is a light green alternating with a deep green color on the leaves.

**Disease Spread** Mosaic virus spreads in the field with the blueberry aphid as the vector (see pages 68–70). Diseased planting stock is responsible for the introduction of mosaic into plantings.

**Control** Insecticides applied for the control of the blueberry aphid should reduce the spread of mosaic disease. Plant virus-tested stock to prevent occurrence in new plantings.

**Stunt** Stunt is caused by a mycoplasma-like organism (MLO), not a virus. Stunt is a very important disease of blueberry throughout the United States and eastern Canada. Most varieties of highbush blueberry are susceptible. Rancocas is the only variety with a high degree of resistance. Stunt is found in wild highbush and lowbush in the woods surrounding commercial plantings. No yield data are available on loss caused by stunt, but symptomatic bushes are usually less than half the size of healthy bushes and crop varies from very light to none.

**Symptoms** Overall dwarfing of the bush is the primary symptom, hence the name stunt. Small leaves that are cupped downward or puckered are characteristic symptoms. Leaves on infected bushes are often chlorotic, with chlorosis most pronounced along the leaf margins and between lateral veins. Midribs and lateral veins usually retain normal green coloration. Chlorotic areas often turn a brilliant red in the late summer. Stem internodes become shortened,

and growth of normally dormant buds causes twiggy branching (photos 118–120).

**Disease Spread** Stunt is actively spread in the field by the sharp-nosed leafhopper (see page 68). The pattern of disease spread with stunt appears random. Leafhoppers are strong fliers and may come into a field from a great distance. Diseased planting stock is also an important mode of introduction of the disease into a planting.

**Control** Insecticides applied on a timely basis to control the leafhopper helps keep the disease in check. Research has shown that leafhopper populations start increasing at about the time of petal fall. Under Michigan conditions one peak brood occurs in early July and a second in early September. Roguing and destroying symptomatic diseased plants is very important in controlling the disease. Use virus-tested planting stock when establishing a new field.

## Fungal Diseases

---

**Alternaria Fruit Rot and Leaf Spot** *Alternaria* fruit rot is recognized as an important postharvest disease, but it can also affect ripe berries before harvest. Preharvest losses are recognized as a serious problem in some years in Michigan, and may be important in other regions as well. *Alternaria* leaf spot has been reported as a problem only in the southeastern United States.

**Symptoms** The main symptom of *Alternaria* fruit rot is a black or dark green moldy growth on the blossom end of the berry (photo 121) appearing shortly before harvest. Leaf spots are brown and circular or irregularly-shaped, surrounded by a red border. Spots may enlarge up to  $\frac{3}{16}$  inch in diameter under conditions of high humidity, but are reduced in size and may only appear as small flecks under conditions of low humidity.

**Causal Organisms and Disease Cycle** The disease is caused by *Alternaria alternata* (also called *A. tenuissima*); other species of *Alternaria* may also cause fruit rots. *A. alternata* is a very common fungus found on decaying plant parts and is, therefore, generally present in agricultural settings. Development of fruit infections is poorly understood, but it is presumed that overripe or injured berries are particularly susceptible to decay. Wet or humid conditions favor growth of the fungus. The optimum temperature for fungal activity is 82°F, although it is reported that the optimum temperature for development of leaf spot is 68°F.

**Control** No specific control programs are recommended for these diseases, although a regular fungicide program using a broad-spectrum material will provide some control of fruit rots. Cultural practices that will minimize fruit rot include prompt harvesting to prevent fruit from becoming overripe, rapid postharvest cooling, avoidance of injury to the fruit, and general sanitation measures.

**Anthracnose** Anthracnose fruit rot (sometimes called “ripe rot”) can be a serious disease in most blueberry production regions of North America. Significant losses do not generally occur unless the growing season is relatively wet and warm.

**Symptoms** Infections are most common at, but not confined to, the blossom end of the fruit. When ripening fruit is turning blue, infected regions will become slightly sunken, giving the surrounding area a puckered appearance (photo

122). Under wet or very humid conditions, a thin layer of pink or salmon-colored slime will develop on the surface of the infected sites. Sometimes, infections do not become apparent until after berries have been harvested. In addition to fruit rot, the anthracnose fungus may also attack new shoots, flowers, and leaves, although these infections do not generally cause direct economic losses.

**Causal Organism and Disease Cycle** Anthracnose is caused by the fungus *Colletotrichum gloeosporioides* (also called *Glomerella cingulata* when it makes a certain type of spore). This same fungus also causes disease on apples (bitter rot), strawberries, tomatoes, and other fruits and vegetables.

The anthracnose fungus overwinters in infected twigs, which it enters by growing through blighted blossom clusters or the small stems (pedicels) of infected fruit. Spores are produced during wet periods throughout the growing season and are distributed to susceptible tissues by splashing rain. It has been suggested that at least 12 hours of continual wetness is required at temperatures of 59 to 81°F in order for these spores to germinate and cause infection. The fungus is relatively inactive at temperatures below 59°F.

Fruit is susceptible to infection at any time of their development, although the period from flowering through the green fruit stage may be critical if weather conditions are favorable. Infections that occur during this time are not immediately apparent but remain “dormant” until the fruit begins to ripen, at which time they become active again and cause the typical rot symptoms.

**Control** Pruning and destroying dead wood in the early spring will reduce inoculum of several disease-causing fungi, including anthracnose, and should be a standard part of any pest management program. Nevertheless, this practice will not control anthracnose by itself in plantings with a history of the disease if weather conditions are favorable for its development. If anthracnose has been a recent problem in a field, fungicide sprays may be needed during periods of warm, wet weather from bloom onwards. Check local recommendations for approved materials and restrictions.

**Botrytis Blight** Botrytis blossom and twig blight is a serious disease of highbush blueberries in the Pacific Northwest, but occurs only sporadically in most other regions. The same fungus can cause an important postharvest decay of packaged fruit in many areas.

**Symptoms** After a few days of wet or foggy weather, infected blossom clusters turn brown, and may appear to have been killed by frost (photo 123). If wet or foggy weather continues, these blossoms will clump together and be covered with gray fungus spores that look like dust (photo 124). The fungus may continue to grow through the blossoms into the stem, killing the stem above this point. Young, succulent shoots or leaves may also be attacked if the weather remains wet for a prolonged period of time.

**Causal Organism and Disease Cycle** Botrytis blight is caused by the fungus *Botrytis cinerea*, the same organism that causes gray mold of strawberries, raspberries, and other horticultural crops. It survives on dead leaves and decaying organic matter on the ground, producing large numbers of spores during periods of wet and humid weather.

These spores are blown by air currents, and infect frost-injured or young, succulent plant tissues under conditions of prolonged moisture or very high humidity. The length of time necessary to establish blossom and twig blight infections is not known for certain, but disease outbreaks are usually associated with several days of continuously wet weather during bloom. The optimum temperature for infection of strawberry blossoms by *B. cinerea* is 59 to 77°F, and is probably similar for blueberry blossoms. Progressively longer periods of moisture are necessary to produce infection at temperatures outside this range.

**Control** Whenever possible, avoid establishing new plantings in fog pockets or next to heavily wooded areas that will reduce air movement. Cultural practices that improve air circulation within a planting, such as pruning, will lower the humidity around flowers and hasten their drying after a rain, interfering with the ability of the fungus to cause disease. Fungicide sprays during the bloom period may be necessary if weather forecasts indicate the probability of several days of continuously wet weather at favorable temperatures. Consult local recommendations for approved materials and restrictions.

### ***Fusicoccum* (*Godronia*) Canker**

Fusicoccum canker is a serious disease of highbush blueberries in the more northern, colder regions of Michigan and New York. In Michigan, fusicoccum canker is the most important cane disease of blueberries in the northern half of the state, whereas another canker disease (phomopsis canker, discussed later) is much more important south of this region. Fusicoccum canker is also considered to be the most serious stem disease of young blueberry plantings in the Pacific Northwest, but has not been reported in North Carolina or other southeastern states. Jersey, Earliblue, Bluecrop, and Coville are particularly susceptible.

**Symptoms** The most conspicuous symptom is the “flagging” or wilting and death of individual stems during the summer (photo 125), although such flagging may have several causes. The most diagnostic symptom of fusicoccum canker is the formation of dark red or brownish-purple infected areas (lesions), 1 to 6 inches long, near the base of young canes. These lesions usually center around a bud, and may alternate in color to give a bull's-eye pattern (photo 126). They may also contain a mass of tiny black dots (pycnidia), which are the spore-containing structures of the fusicoccum fungus.

### ***Causal Organism and Disease Cycle***

Fusicoccum canker is caused by the fungus *Fusicoccum putrefaciens* (also called *Godronia cassandrae*). The fungus overwinters in blueberry stem cankers and begins to produce infective spores (conidia) within the pycnidia in the cankered areas. These conidia are produced throughout the growing season, but the greatest numbers appear to be produced between bud break and flowering. This also appears to be the time during which canes are most susceptible to infection.

Conidia are moved about almost entirely by washing and splashing rainwater. When they are deposited on a susceptible young cane (up to 2 years old), they can germinate and infect if temperatures are favorable and the cane remains wet for a sufficient length of time.

The precise conditions necessary for infection are not known, but controlled experiments show that 50°F and 72°F are equally favorable, and infection

does not occur at 86°F. Although the time between dormancy and flowering is probably the period of greatest activity, infections can occur during rains throughout the entire growing season.

**Control** Prune out and destroy cankered stems to reduce the source of infective spores. Prune bushes and control weeds to improve air circulation and reduce drying time after a rain. Some broad-spectrum fungicides may provide additional control if used on a regular basis; check local recommendations for availability and restrictions. Because fusicoccum canker activity appears to be greatest during the prebloom and bloom period, it may be desirable to concentrate a fungicide program during this time if the disease has been a problem and it is undesirable or impractical to maintain protection season long. Some fungicides active against mummy berry are not active against fusicoccum canker and vice versa. Consult labels and local recommendations.

**Mummy Berry** Mummy berry is the most common fungal disease of blueberries in North America. It occurs in most geographical regions where blueberries are grown commercially. Disease severity varies greatly from year to year depending upon weather conditions, but large crop losses can occur when weather is wet in the spring and control measures are not undertaken. Susceptible varieties include Bluecrop, Bluejay, Collins, Earliblue, Weymouth, Jersey, and Berkeley; Collins is somewhat resistant.

**Symptoms** Mummy berry has two distinct phases: shoot blight and a hard rot of the fruit. Shoot blight symptoms first appear a few weeks after bud break, but often are inconspicuous and easy to overlook. New leaves or shoots that become infected wilt and die quickly, turning dark brown (photo 127). Under wet or humid conditions, a light gray or cream colored powdery mold develops on blighted tissues (photo 128).

Fruit infections do not become apparent until healthy berries start to ripen and turn blue. At this time, infected berries (“mummy berries”) become whitish pink or salmon in color (photo 129), shrivel, and fall to the ground. Cutting such berries open shows that all or part of the fruit has been replaced by growth of the mummy berry fungus (photo 130). Infected berries that fall to the ground become pumpkin-shaped as they continue to shrivel, and finally turn dark brown.

**Causal Organism and Disease Cycle** Mummy berry disease is caused by the fungus *Monilinia vaccinii-corymbosi*. This fungus infects only cultivated blueberries and a few closely related wild blueberry species. Therefore, it is likely that the disease is usually introduced from neighboring plantings in which it has already become established or from wild blueberries in nearby woods.

Once it has been introduced, the mummy berry fungus overwinters in the mummified fruits that fall to the ground near harvest. Under moist conditions in the early spring, the fungus starts to form small mushroom-like fruiting bodies (photo 131) from the mummies that have remained on the soil surface. These fruiting bodies, called apothecia, continue to develop under favorable conditions—activity is very slow at 50°F or lower, but 61°F is optimum—and eventually form sacs of spores, called asci. Asci begin to discharge their infective ascospores about the time that green tissue first emerges from the buds of the blueberry plants. Ascospore discharge continues for 4 to 5 weeks,

usually reaching a peak about 2 weeks after bud break. These spores are distributed by wind currents, and those that land on emerging leaves can germinate and infect if the leaves remain wet from rain or dew for a sufficient length of time. The minimum period of leaf wetness necessary for infection to occur is about 6 to 12 hours at the optimum temperature of 59°F, and is somewhat longer at lower temperatures.

Once new leaves and shoots become infected, the fungus produces a second type of powdery cream-colored spores (called conidia) upon these infected tissues. Conidia are distributed to open flowers of the blueberry plant by wind or insects, which are attracted to sugars exuded by the blighted leaves and shoots. The conidia germinate, presumably during wet periods, and the fungus grows into the ovaries of the flowers, causing the seeds to abort. As infected berries develop, they become filled with growth of the fungus, turn pink, and drop to the ground, thus completing the disease cycle.

*Control* Mummified fruit develops only when flowers are infected by conidia, and conidia are present only after young leaves and shoots have become infected by ascospores. Therefore, the key to control of mummy berry disease is to prevent these leaf and shoot infections by interfering with the production of ascospores and applying appropriate fungicides as necessary.

An application of urea fertilizer or a shallow cultivation of the ground between rows and beneath infected bushes before bud break will greatly inhibit the production and functioning of the mushroom-like apothecia, the source of infective ascospores. Relatively few apothecia are formed from mummies buried just ½ inch beneath the surface, and none are formed from mummies buried 1 inch or deeper. In isolated plantings, this single step may provide acceptable control in years with relatively few overwintered mummy berries (i.e., little fruit infection the previous season) or those in which spring weather conditions are only marginally favorable for disease development.

Fungicidal control also may be necessary in many plantings. The number and timing of sprays should be based upon disease pressure, as determined by a combination of weather conditions (favorable temperatures and wetness) and the relative amount of ascospore inoculum available for the season. Factors that influence inoculum availability include disease severity in the previous year, whether or not cultivation has been employed, and to a lesser extent, the distance from neighboring fields that might supply windblown ascospores. In general, heavy disease pressure may require fungicidal protection from bud break until bloom, whereas lighter pressure may only require a single spray 1 to 2 weeks after bud break during the period of greatest ascospore production. Some fungicides also can be used to protect flowers from infection by conidia, but these sprays will not be necessary if shoot blight infections are controlled. Check local recommendations for available materials and restrictions.

### ***Phomopsis Canker and Twig Blight***

Phomopsis canker is considered to be a serious problem in southern Michigan, Indiana, Illinois, and New York; it is likely to be a problem in neighboring states with similar climates. The same fungus also causes twig blight in these states. Phomopsis twig blight is a major problem in North Carolina, where the fungus also causes decay of ripe fruit. However, stem cankers usually seem to be caused by different organisms in North Carolina.

**Symptoms** As with other canker diseases, the most conspicuous symptom is the “flagging,” or wilting and death of individual stems during the summer (photo 132). Under severe disease conditions, several individual canes may be affected on a single bush. When phomopsis canker is responsible for this symptom, the actual infection site is much less noticeable than when fusicoccum canker is involved (see page 87), and appears primarily as an elongated flattened area, usually near the base of the cane (photo 133). Small black dots that are the spore-containing bodies (pycnidia) of the phomopsis fungus can sometimes be seen within this flattened area. Twig blight symptoms usually consist of a tip dieback of about 2 to 6 inches on current-year wood. Small black pycnidia may also be produced upon the blighted twigs.

**Causal Organism and Disease Cycle** Phomopsis canker and twig blight is caused by the fungus *Phomopsis vaccinii*. It overwinters in infected twigs and canes, and produces infective spores within the pycnidia arising from these infection sites. These spores ooze from the pycnidia during wet or humid periods and are spread by washing, splashing, and windblown raindrops. In Michigan, spores are released during rainy periods from bud break through late August, although the greatest numbers appear to be released during the bloom and petal fall period. The spores can then germinate if conditions remain wet and temperatures are suitable, and enter the twigs or canes through injury sites, particularly those caused by winter damage or early spring frosts. Precise environmental conditions for infection have not been determined, but temperatures between 70 and 81°F appear to be very favorable, whereas 50 to 59°F appears to be much less favorable; no activity occurs at 90°F.

**Control** The primary control practices are cultural. Avoid planting sites that are prone to spring frosts and employ fertilization, irrigation, and weed control practices that will discourage late-season growth and promote early hardening off. Prune out and destroy dead twigs and canes before bud break in the spring; when removing dead canes, cut as deeply into the crown as possible to insure removing the canker. A regular fungicide program through August will also provide additional benefit. Because the number of infective spores appears to be greatest during flowering, it may be desirable to concentrate a fungicide program during this time if the disease has been a problem and it is undesirable or impractical to maintain protection season long. Fungicides active against mummy berry may not be active against phomopsis canker and vice versa. Consult labels and local recommendations.

**Phytophthora Root Rot** Phytophthora root rot is a serious disease of blueberries in southern Missouri, Arkansas, and the southeastern United States. It has also been documented in California, and may occur in other temperate areas along the Pacific Coast. The disease has not been reported in the upper Midwest or the Northeast, with the possible exception of New Jersey. Phytophthora root rot is unlikely to become a serious problem in colder regions, since the fungus that causes it does not readily survive prolonged periods of subfreezing soil temperatures. Patriot is the only variety to show resistance.

**Symptoms** Infected plants are usually associated with relatively wet soils or locations within a field that are slowest to drain. The first symptoms of phytophthora root rot include a yellowing or reddening of leaves, sometimes with a burning or scorching around the leaf edges. Plants start to become stunted due to a

lack of new terminal growth, and leaves begin to drop near the base of affected canes. As the disease progresses, defoliation continues until only a few small leaves are left at the top of the canes. Digging around infected plants shows that their root systems are much smaller than those of healthy plants, and many of the fine feeder roots are dead and black or reddish-brown.

**Causal Organism and Disease Cycle**

Phytophthora root rot is caused by the soil-borne fungus *Phytophthora cinnamomi*. This same fungus attacks almost 1,000 other plant species, including rhododendron, Fraser fir, cranberry, and numerous tropical and subtropical crops and ornamentals.

The fungus overwinters primarily as dormant resting spores, which germinate to form sacs of infective spores (zoospores) when the soil is moist and soil temperatures are above 59°F. When the soil is completely saturated and temperatures remain warm (59 to 86°F), the zoospores are discharged into the soil and swim short distances to plant roots through the water-filled soil pores. Zoospores may also swim to the soil surface and be carried downhill by runoff water to other plants or to irrigation ponds, streams, and canals by which they can be spread long distances.

When a zoospore contacts a plant root it may germinate and cause infection, which is usually more severe the longer that the soil remains saturated. New zoospores are then produced from new infection sites whenever temperatures are favorable and the soil becomes saturated. Disease severity is therefore related to how often a soil becomes saturated in addition to how long individual saturation periods last; for example, more than 24 hours in standing water promotes infection. Finally, the fungus produces its resting spores within infected roots, which are released into the soil when the dead roots decay, completing the disease cycle.

**Control**

The key to control is good site selection and soil water management. Do not establish plantings in excessively wet sites, and tile or provide supplementary drainage in marginal sites. Planting bushes on a ridge at least 12 inches high is another method of removing most of the root system from the zone of pathogen activity (saturated soil) in marginally drained sites or in excessively wet years. Do not irrigate excessively and, if possible, avoid using irrigation water from ponds, streams, or canals that are known or suspected to be contaminated with this fungus. Buy plants only from a reputable source, since *P. cinnamomi* can be distributed on symptomless planting stock if it is propagated in contaminated soil. A fungicide specific for control of diseases caused by *Phytophthora* and related fungi will also provide additional control when used in combination with cultural practices to avoid excessively wet soils. Check local recommendations.

**Stem Blight**

Stem blight is considered to be one of the major diseases affecting blueberries in North Carolina, where severe losses result from the infection and rapid death of young transplants within 2 years of placement in the field. The northern limits of this disease are not known, as it has not been recognized in New York, Michigan, or the Pacific Northwest. However, the same fungus that causes stem blight of blueberries is a common cause of cankers on apple trees as far north as Pennsylvania.



**Symptoms** Characteristic symptoms include a yellowing and reddening of leaves on one or more branches followed by their wilting and death. The woody tissue of infected branches becomes brown or pecan colored, often on only one side of the affected stem. Dead tissue may extend for only a few inches or it may extend along the entire length of the stem. Plants are most likely to die when infections occur near the crown.

**Causal Organism and Disease Cycle** Stem blight is caused by the fungus *Botryosphaeria dothidea*. This same fungus causes “white rot” or “Bot rot” on apples (tree cankers and fruit rot) in the warmer, humid regions of the United States and a “gummosis” disease of peach trees in the Southeast.

The fungus overwinters in the wood and bark of infected canes; it can infect many different woody forest plants which serve as reservoirs of inoculum if located near susceptible plantings. Spores are produced throughout the growing season in the southeastern United States, although they are spread (both by wind currents and splashing rain) primarily during warmer weather. The spores germinate in a film of water or under conditions of extremely high humidity and infect the canes primarily through wounds. Precise conditions required for infection to occur have not been established, although optimum temperatures for spore germination are 82 to 90°F.

**Control** Because the fungus persists in dead wood, it is important to prune and destroy all dead twigs and canes early in the growing season. Piles of dead prunings remaining at the edge of a planting can become infected and serve as a source of inoculum, and should be burned or chopped with a flail mower to remove their bark. Broad-spectrum fungicides applied before periods of infection can be of some benefit; check local recommendations.

**Stem Canker** Stem canker is one of the most important factors limiting production of highbush blueberries in southern states. The disease has also been found in New Jersey, but is considered only of minor importance in the Pacific Northwest. It has not been documented in the Great Lakes region or in the eastern seaboard states north of New Jersey.

**Symptoms** Only the current season’s growth is susceptible to infection. Small red areas first develop on succulent stems about 1 to 2 weeks after infection, then become swollen and cone-shaped in about 4 months on susceptible varieties. Large swollen cankers with deep cracks in their bark develop on susceptible varieties (photo 134), whereas canker growth is restricted on more resistant varieties. In susceptible varieties, the fungus continues to grow into the wood of the stem until it eventually girdles the canes, and the leaves wilt and die. In resistant varieties, the fungus is restricted to the surface of the stem and only superficial raised areas of infection are seen.

**Causal Organism and Disease Cycle** Stem canker is caused by the fungus *Botryosphaeria corticis*, a related but distinct organism from that which causes stem blight. The fungus overwinters in diseased wood and releases spores during wet weather during the spring and early summer. The spores germinate in a film of water on new stems and infect within 6 to 24 hours if temperatures are favorable. The optimum temperature for disease development is 77 to 82°F, with increas-

ingly lower temperatures limiting development. Little disease development occurs below 61°F. The disease may also be spread when infected wood is used for propagating new plants.

**Control** Stem canker is best controlled by planting uninfected plants of resistant varieties. Some broad-spectrum fungicides may also provide partial control in established plantings of susceptible varieties. Consult local recommendations and restrictions.

**Powdery Mildew** This disease seldom causes yield losses, but its symptoms are sometimes confused with those of red ringspot disease (see pages 83–84). Because control measures for these two diseases are very different, it is important to distinguish between them. Powdery mildew is not a serious disease, but premature defoliation caused by mildew can affect long-term productivity.

**Symptoms** In susceptible varieties, leaf surfaces contain white mycelia and spores (photo 135). Either the upper or lower leaf surface can be affected. Chlorotic spots with reddish borders are common on the upper leaf surface, similar to symptoms caused by red ringspot (photo 114). Water-soaked areas on the lower surface opposite the chlorotic areas distinguish mildew from the virus.

**Causal Organism and Disease Cycle** *Microsphaera penicillata* is the causal organism. The fungus overwinters in buds near the tips of canes. Emerging shoots and leaves are infected in spring as air currents transport the spores. Repeat cycles of infection can occur throughout the summer. Infections do not require wet conditions to develop, but infections will become more severe under humid conditions.

**Control** Since symptoms usually do not appear until after harvest, most growers do not attempt to control the disease. Improving air circulation by pruning can help reduce mildew. Planting resistant varieties is the most effective way to reduce the disease, but other varietal considerations are often more important. Berkeley, Earliblue, and Ivanhoe are resistant; Bluecrop, Rancocas, Weymouth, Pemberton, and Dixi are moderately susceptible; and Collins, Rubel, Blueray, Herbert, and Jersey are very susceptible.

**Witches' Broom** Witches' broom is a minor disease in blueberry plantings, but can be found throughout the country where plantings are in close proximity to fir trees (*Abies* sp.). The pathogen is a member of the rust fungi.

**Symptoms** An unusual number of broomlike, swollen, cracked shoots arise from lateral buds. Many brooms can appear on a single plant (photo 136).

**Causal Organism and Disease Cycle** *Pucciniastrum goeppertianum* completes part of its life cycle on species of fir, and the other on various *Vaccinium* species. Aeciospores, produced only in pustules on fir needles, are carried by wind to the blueberry plant, where germination occurs. The spores germinate and stimulate the production of a cytokinin-like growth hormone, causing excessive lateral bud break. Spores produced on swollen shoots are carried back to fir trees, where they infect new needles. The fungus requires both hosts to complete its life cycle. The disease cannot spread from one blueberry plant to another.

*Control* Fungicides are not effective for controlling this disease. Elimination of the secondary host (fir trees) within several hundred yards of the planting will reduce further infection. The fungus is systemic; once blueberries are infected, they will always have the disease. Infected bushes and their associated root systems must be killed to eliminate this source of inoculum.

## ***For More Information***

---

Converse, R.H., ed. *Virus Diseases of Small Fruits*. USDA Handbook 631. Washington, D.C.: Government Printing Office, 1987.

## **Chapter 10**

# **WEED MANAGEMENT**

---

Management of weeds in blueberries is important for several reasons. First, weeds directly compete with plants for water, nutrients, and light. Second, some weeds serve as alternate hosts for insects and diseases. Weeds near the plant can increase humidity, improving conditions favoring fungal pathogens. Weeds can interfere with harvesting and irrigating, and weeds flowering simultaneously with blueberries can compete for pollinating insects.

Blueberries are not particularly vigorous plants and do not compete well with weeds. The roots of many weed species occupy the same soil zone as the shallow roots of blueberries. The leaf canopy in mature plantings usually provides enough shade to control some weed growth within the rows, but blueberries may require 8 years or more to develop a full canopy. Controlling weeds in younger plantings is a constant challenge.

Weed species and control techniques vary by region. General control strategies will be discussed in this chapter. Specific recommendations regarding particular weed species and appropriate herbicides should be obtained from the Cooperative Extension System in each state.

## ***Preplant Weed Control***

---

Eliminating weeds before planting is critical because of the difficulty in controlling perennial weeds once the planting is established. For example, several herbicides which are effective and safe on mature bushes can injure young bushes. In addition, weeds are most competitive with young plants, and weedy plantings may require twice as long to reach optimum production levels as plantings without weed competition.

Inadequate weed control before planting often results in problems for several years. Planting proposed sites to rye or other green manure crops a year before planting blueberries will suppress most weeds. If troublesome perennial weed species are present (quackgrass, thistle, bermudagrass, johnsongrass, wild blackberry, etc.), a combination of systemic postemergent herbicide applications and cultivation should be used (see chapter 3).

## ***Weed Control in New Plantings***

---

A combination of techniques is usually required to control weeds during the planting year. Newly planted bushes are sensitive to most preemergent herbicides. Consult your local Cooperative Extension System for information on the safest preemergent herbicides. Weeds emerging in the plant rows can be controlled by cultivation and hand hoeing (photo 137). During the first year, some contact (postemergent) herbicides can be used to spot-treat weeds.

Various mulch materials also provide effective weed control around new plants. A 3- to 5-inch layer of bark, wood chips, or sawdust will suppress most weeds. Mulching is an important component of blueberry culture on

upland soils, and may be essential in these situations (see chapter 5). Some synthetic weed-barrier fabrics which allow rain to penetrate may be useful in blueberry production (photo 138). Bushes can be planted through holes in these materials, and the fabric prevents weeds from growing within the rows. Weeds can, however, grow through the same holes as the blueberries; they are difficult to extract. Whether these materials are cost effective is not clear.

Weeds emerging between the rows in new plantings are most easily controlled by cultivation. Do not cultivate deeper than 3 inches, as blueberry roots are shallow and may be injured. After the first year, treat young plantings with preemergent herbicides within the row to control most weeds.

## **Weed Control in Established Plantings**

### **Weed Control Within Rows**

Weed growth within the rows must be closely controlled. Usually a well-planned program of preemergent herbicides is most effective and economical. Several materials are registered for use on blueberries; consult your Cooperative Extension System for recommendations. Consider the primary weed species present, as herbicides vary in the range of weeds they control. Type and texture of soil often dictate which herbicides and rates will be safe. Injury can result when herbicides are not applied in accordance with the label and soil conditions (photos 139–144).

Most preemergent herbicides are applied in the early spring or late fall. Adding a contact (postemergent) herbicide to this spray will usually control herbaceous weeds which are already present. Combinations of more than one preemergent herbicide often control a broader spectrum of weeds. Avoid using the same herbicide repeatedly. Continued use of one or two materials will result in a population of weeds which are resistant or tolerant to those products. Rotate herbicides from one year to the next. Most preemergent herbicides applied in late fall or spring lose effectiveness by the middle of the summer. However, weed competition late in the season is much less of a concern than early-season weed growth. Weed growth late in the season is beneficial; weeds remove excess nitrogen and water from the soil and encourage blueberries to terminate growth and begin hardening off for the winter.

Read and follow the directions on all herbicide labels. Recommended rates are usually given for a treated acre of soil. If you are spraying only under the rows and leaving row middles untreated, calculate the amount of herbicide you need based on the area which will actually be treated.

### **Weed Control Between Rows**

Row middles can be managed vegetation free, as a seeded sod, or with native vegetation. Grower preference, marketing methods, and local conditions are the factors to consider when choosing the right approach.

Row middles can be maintained vegetation free by periodic cultivation (photo 145). This common management practice appears to be most beneficial on lighter soils where vegetation competes strongly for moisture and nutrients. Cultivation also provides some frost protection. Open, hard soil surfaces radiate more heat than sodded ground so that during frosty nights, temperatures may be slightly higher in cultivated patches. However, clean cultivated soils are prone to erosion, so this should not be practiced in plantings on hills.

Row middles can also be maintained in a temporary vegetation cover. The benefits of a cover crop are improved accessibility for equipment and people and a reduction in erosion potential. Covers use excess water so that field operations are not hampered following rains. Covers also limit soil compaction from machinery, which is a concern in mechanically harvested fields. Cover crops gradually contribute organic matter and stabilize erodible soils.

The primary drawback of cover crops is that they often compete with blueberry plants for nitrogen and moisture. Most grasses produce fibrous, shallow root systems similar to those of blueberries. However, grasses are much more competitive and aggressive than blueberries. Cover crops must be managed, by mowing or chemical suppression, to limit interference with blueberries.

The competitive nature of cover crops can be used to the advantage of the blueberry grower. A cover crop seeded between rows in August will accelerate the hardening process and reduce the chance of winter injury. If the cover crop is not winter hardy, it will be killed during winter, but the residue can reduce erosion and inhibit some weed seed germination.

A permanent native cover can be established by regular mowing. Mowing eventually selects for annual and perennial grasses which provide a suitable cover in most areas. Because no reseeding is required, growers typically till under native covers during periods of drought to conserve moisture. Covers can also be tilled prior to predicted spring freezes to help conserve heat and reduce freeze injury to buds and flowers. A disadvantage of native covers is that they usually contain undesirable species such as broadleaf weeds and quackgrass, which tend to spread into the plant rows if appropriate control measures (herbicides, cultivation) are not used. Also, the incidence of mummy berry (see pages 88–89) tends to be greater because middles are not disced in spring when mushroom-like cups are developing. Native plants can also harbor harmful pests. In addition, variable density and bare spots are typical of native covers.

Row middles can also be seeded to specific permanent sod species (photo 146). This provides the most attractive, uniform cover and may be desirable for pick-your-own operations. Most perennial cover crops require additional water and fertilizer to establish properly. The seeding and additional maintenance costs should be weighed against potential benefits. An ideal sod species should be vigorous enough to inhibit weeds from establishing, but not compete excessively with blueberries for water and nutrients. Sods must also be durable enough to withstand machinery and foot traffic.

The fine-leaf fescues offer a good combination of relatively low water demand, compact growth habit, and durability, as well as insect, nematode, and disease resistance. Several attractive grass seed mixtures have been developed by turf breeders for low-maintenance lawns and fairways (photo 147). These “companion” grass mixes also appear suitable as permanent sods in the alleys of blueberry plantings, though definitive field trials have yet to establish their utility. Most are mixtures of fine-leaf fescues, perennial ryegrasses, or bluegrass. They form a thick sod which holds up well under traffic and needs infrequent mowing during the summer months. Even these “ideal” companion grass mixes will require occasional irrigation, nitrogen

fertilizer, and renovation every few years to compete with undesirable perennial weeds like quackgrass, plantain, or nutsedge. Some special turf fertilizers contain a broadleaf herbicide, usually 2,4-D, which can be toxic to blueberries. Avoid using these in the planting. Three or four mowings per summer will usually control weeds and reduce water demand in the turf.

Although less competitive than other turf grasses, companion mixes will harm blueberries if allowed to crowd the rows. Experiments have generally indicated that no amount of irrigation or nitrogen fertilizer will fully compensate for the impact of uncontrolled weeds or sod grasses on perennial crops. Therefore, maintain a weed-free strip within the row approximately 3 to 5 feet wide. Since cultivation within the row damages roots, heavy mulches or preemergent herbicides are usually necessary to maintain a weed-free strip.

Grass-selective herbicides can be used to help prevent alley sods or grass weeds from invading the rows, without much risk of inadvertent damage to canes. However, the fescues, especially fine-leaf fescues, are somewhat resistant to postemergent grass herbicides. While general systemic and contact herbicides are very effective against these grasses, they are also toxic to blueberries. Selection of noncreeping type fine-leaf fescues will minimize the need for herbicide sprays to prevent the sod from encroaching on the rows. Preemergent herbicides can be used to effectively control weed or alley sod encroachment into the blueberries.

Covers require mowing 3 to 5 times each year. Keep row middles mowed short early in the season when blueberries are growing most rapidly and competition between bushes and cover vegetation is most damaging. Covers can be allowed to grow taller after harvest since bushes benefit from some competition in the fall. This will use excess moisture and nitrogen and encourage bushes to harden off for winter.

Additional phosphorus and nitrogen may be required to establish a cover crop between rows of blueberries. Most cover crops will benefit from an additional 60 pounds of phosphorus and 30 to 60 pounds of nitrogen per acre. A soil test can provide precise recommendations.

Weed management is essential for optimizing blueberry growth and productivity. Elimination of perennial weeds prior to planting and control of weeds during plant establishment are critical. Once blueberry plants are well established, herbicides and mulches can be used to maintain a weed-free strip within the row, and sod alleys or cultivation can be used to prevent weed invasion between rows.

## ***For More Information***

---

Burrill, L. C. et al. *PNW Weed Control Handbook*. Corvallis, Oregon: Oregon State University Cooperative Extension, 1991.

Lorenzi, H. J. and L. S. Jeffery. *Weeds of the United States and Their Control*. New York: Van Nostrand Reinhold, 1987.

*Weeds of the North Central States*. North Central Regional Research Publication No. 281. Champaign, Illinois: University of Illinois, 1981.

## Chapter 11

# NUTRIENT MANAGEMENT

---

Twelve soil-derived nutrients are required for growth of all plants. Of these, nitrogen, potassium and phosphorus are required in the greatest amounts; calcium, magnesium, and sulfur in moderate amounts; and iron, boron, manganese, copper, zinc, and molybdenum in small quantities. Most crop producers apply large amounts of nitrogen, potassium, and phosphorus to replace that lost through harvesting. However, plants will not grow well if any of the 12 nutrients are deficient. One objective of the blueberry grower should be to maintain sufficient levels of all the essential nutrients.

Blueberries require acid soils and have a lower demand for most nutrients than other fruit crops. As a result, blueberries require little supplemental fertilization and are sensitive to too much fertility.

## ***Symptoms of Nutritional Problems***

---

Visual symptoms are often useful in diagnosing specific nutritional problems, although inaccurate diagnoses are quite common because similar symptoms may be caused by different nutrient deficiencies, or result from other stresses (water, herbicides, pests, or disease) not related to nutrition. Growers should not fertilize based on symptoms and bush appearance alone, as deficiency symptoms occur only after acute nutrient shortage. In most cases, yield or bush health has been severely affected by the time symptoms appear. Soil and leaf analyses should be conducted regularly to prevent this from happening.

***Nitrogen (N)*** Inadequate nitrogen causes a general reduction in bush growth. New shoot growth and leaf size are reduced, and few new canes are initiated. Leaves are pale green (chlorotic) in color, opposed to the lush, dark green of adequately fertilized plants (photo 148). The chlorotic coloring is uniform across the leaf, with no mottling or pattern. The older or lower leaves usually develop a pale color before younger leaves at the top of shoots. Severely deficient bushes seldom produce more than one flush of growth per season. Leaves of deficient plants often develop fall colors and abscise early. Nitrogen-deficient plants produce short shoots, usually with fewer flower buds, so yield is reduced.

Excessive nitrogen causes abundant vigorous shoots and large, dark green leaves. Bushes may produce numerous growth flushes. Often the last flush occurs too late in the season to properly harden off before winter. Tips of these shoots, and occasionally whole canes, are winter killed. Bushes receiving too much nitrogen often produce fewer berries which are smaller and ripen later.

***Phosphorus (P)*** Symptoms of phosphorus deficiency have only been observed experimentally by removing the phosphorus supply from young plants. Symptoms have not been seen on field plants. In addition, field plants seldom respond to phosphorus applications.

Plants deficient in phosphorus may be generally stunted with smaller leaves. Leaves may be dark green to purple at the tip and margins; they may also lay



unusually flat against the stem. Twigs are narrow on deficient plants and may also exhibit a red-purple color (photo 149).

Symptoms of excessive phosphorus have not been reported, but high levels of phosphorus are known to inhibit iron uptake and may induce iron deficiency.

**Potassium (K)** Potassium deficiency causes dieback of shoot tips, and occurs on sandy soils. Leaves may develop several symptoms, ranging from scorching along the margin, cupping and curling, and necrotic spots. Younger leaves toward the tip of shoots may develop chlorosis between veins similar to that caused by iron deficiency (photo 150).

**Calcium (Ca)** Symptoms of calcium deficiency have been observed by removing the calcium supply to plants experimentally, and include chlorosis between the veins of the youngest leaves. Older leaves may be scorched along their margins. Symptoms are rarely observed in the field, however. An excess of calcium raises the soil pH and induce iron toxicity.

**Magnesium (Mg)** Symptoms of magnesium deficiency have been induced experimentally and observed in commercial plantings. These include a distinctive pattern of chlorosis between the main veins of leaves. These regions may turn yellow to bright red while tissue adjacent to the main veins remains green. This produces a Christmas tree-shaped green area in the middle of leaves (photo 151). Leaves at the base of young shoots are likely to show symptoms first. Young leaves at the tips of shoots are seldom affected.

**Sulfur (S)** Sulfur is often applied to blueberries to reduce soil pH, but sulfur deficiency has not been reported on field-grown plants where the soil pH was sufficiently low at planting. Young bushes deprived of sulfur experimentally develop leaf symptoms similar to those of nitrogen deficiency, including a uniform chlorosis.

**Boron (B)** Inadequate boron causes a dieback of the tips of blueberry shoots. Leaves close to aborted shoot tips develop a mottled chlorosis and cupped shape. Flower and vegetative buds may fail to open on severely affected plants (photos 152–153). Winter injury is greater on plants with a low boron level.

**Iron (Fe)** Symptoms of iron deficiency are common in blueberries. These include a distinct pattern of chlorosis between leaf veins: main veins and many minor veins remain green. Chlorotic tissue may range from light yellow to bronze (photo 154). Symptoms normally appear first on the youngest leaves toward shoot tips. Shoot growth and leaf size are reduced.

**Manganese (Mn)** Manganese deficiency causes a chlorosis on younger leaves which closely resembles symptoms of iron deficiency. Affected leaves may also exhibit chlorotic regions near the margin, as well as necrotic spots throughout the leaves. Manganese toxicity can occur in some soils when the pH is lowered.

**Copper (Cu)** Copper deficiency has not been reported on field-grown blueberries, but plants grown experimentally under deficient conditions develop symptoms resembling the chlorosis caused by manganese shortages. As the deficiency progresses, shoot dieback may occur.

**Zinc (Zn)** Zinc deficiency has not been reported in the field, but symptoms induced experimentally include a yellowing of young leaves. Yellowing appears uniformly across leaves; no interveinal pattern is produced. Symptoms may develop early in the season.

## Soil Testing

---

Soil testing is a valuable part of blueberry nutrition management. Monitoring soil pH should be a high priority, since pH affects nutrient availability. Blueberries require fairly small amounts of most nutrients, so most soils can supply adequate quantities if the pH is maintained in the proper range.

Soil testing is also useful for estimating the quantities of phosphorus, potassium, calcium, and magnesium which are available to the plant. However, soil tests provide only a crude estimate of how much of a particular nutrient the blueberry bush may actually be receiving. They need to be used in conjunction with leaf analysis to develop the best fertilization strategy. Soil tests are not useful for estimating nitrogen availability; leaf analysis and observations of the amount of vegetative growth are better indicators.

The Cooperative Extension System in most states offers soil testing services. Samples can also be analyzed by private laboratories; however, the lab should have experience making recommendations for blueberry growers.

## Sampling Procedures

Fields to be planted should be tested (see chapter 3). In established plantings, sample the soil every 3 to 4 years. Growers may opt to sample all plantings at once or sample a portion of their acreage on a rotating basis.

Collect soil from within the row down to the rooting depth (16 inches) so that the sample represents the typical conditions to which most roots are exposed. This is particularly important in plantings which have been acidified (see chapter 3). If the acidifying agent (sulfur, aluminum sulfate) was banded over the row only, soil collected between the rows will give a misleading pH value. If the acidifying agent was applied to the soil surface and not incorporated, pH will increase with depth. Collecting separate topsoil (up to 8 inches) and subsoil (8 to 16 inches) samples will provide a better understanding of whether the soil has been acidified adequately. Soils which have been acidified often increase in pH over time so these plantings need to be monitored more frequently than sites on naturally acid soils.

## Interpreting Results

The pH of blueberry soils should be adjusted if needed. Blueberries may perform well when soil pH is between 4.0 and 5.5, but 4.5 to 5.0 appears to be best. Determine the amount of sulfur required to lower the soil pH to 4.5 (see table 4, page 20), and begin a program of acidification. If more than 400 pounds are needed per acre, do not apply the sulfur all at once. Best results are obtained by applying 200 pounds per acre in early spring and again in early fall for as many intervals as are required to apply the proper amount. One year after the last application, sample again to determine if further acidification is necessary.

Soil testing laboratories use various extractants for their analysis, and results are reported differently. For these reasons, contact your Cooperative

Extension System for the most appropriate interpretation of results. When the soil pH is known, a leaf analysis often provides more useful information than levels of soil nutrients.

Soil samples are often taken simultaneously with leaf samples just before harvest. The soil sample may be high in salts because of the short time since the last fertilizer application. If soil samples are taken after fertilization, they may be flagged as having excessive salts. Studies have shown, however, that high salts in summer are usually not problematic as levels return to normal by spring, assuming reasonable amounts of fertilizer have been applied.

## **Leaf Analysis**

---

Leaf analysis is a valuable and often underutilized tool in blueberry nutrition programs. It provides a means of accurately identifying nutritional problems that are difficult to diagnose by soil testing or by observing bush appearance. More importantly, growers can identify and correct potential nutrient shortages before growth or yield is affected. Plants can be nutrient deficient without showing external symptoms.

As with soil samples, one leaf sample should not represent more than 10 acres. Do not combine leaves from different varieties or from single varieties growing on different soil types. On larger farms, different blocks may be sampled during successive years on a 2- to 4-year cycle.

Each sample should consist of 50 to 100 leaves, collected from different bushes throughout the sampling area. Collect leaves from the middle of current season shoots just before or during harvest. Avoid sampling abnormal, weak, or unhealthy plants, unless these will be sampled separately. Wash leaves by swirling them in a dilute detergent solution for several seconds, then rinse briefly in tap water. Let leaves air-dry on a table top before sending them to the lab; wet or moist leaves will rot during shipment.

If the purpose of leaf sampling is to diagnose a suspected nutrient problem, it is helpful to submit two samples. Collect one from affected bushes, and a second from nearby healthy bushes.

Although laboratories may use different procedures for analyzing leaf samples for mineral nutrients, results from reputable labs should be identical. Labs may offer analysis of single nutrients, such as nitrogen, but the cost of complete analyses is usually not that much more.

### **Interpreting Leaf Analysis**

Bushes containing nutrient concentrations below the deficiency levels are likely to respond to nutrient applications (table 6). Sufficient levels indicate the normal range in leaf nutrient concentrations in bushes that are performing well and are not expected to respond to nutrient additions. Usually there is a difference between the deficiency level and the lowest concentration which is considered sufficient. Bushes containing leaf levels slightly below the optimal range would not be expected to respond to nutrient applications, but should be monitored closely. The requirements of some nutrients have been researched extensively (nitrogen, phosphorus, potassium, calcium, magnesium, and iron) and their sufficient and deficient levels are well

**Table 6.** Deficient, sufficient, and excessive nutrient concentrations in blueberry leaves.

NUTRIENT		DEFICIENT BELOW	SUFFICIENT	EXCESSIVE ABOVE
N	(%)	1.7	1.7–2.1	2.3
P	(%)	0.08	0.1–0.4	0.6
K	(%)	0.35	0.4–0.65	0.9
Ca	(%)	0.13	0.3–0.8	1.0
Mg	(%)	0.1	0.15–0.3	0.4
S	(%)	—	0.12–0.2	—
B	(ppm)	20	30–70	200
Cu	(ppm)	5	5–20	—
Fe	(ppm)	60	60–200	400
Mn	(ppm)	25	50–350	450
Zn	(ppm)	8	8–30	80

% by dry weight of blueberry leaf  
ppm=parts per million

understood. The requirements of other nutrients, such as sulfur, boron, copper, manganese, and zinc, are not as well understood. Deficient and sufficient levels of these may change slightly as more information becomes available.

Concentrations of several nutrients in leaves change over time (figure 7, next page). Consider the patterns of seasonal change when interpreting results of leaf analysis.

**Nitrogen** Adjust nitrogen rates to maintain leaf nitrogen levels between 1.7 and 2.1%. Plants containing higher leaf nitrogen levels may actually yield less. Fruit maturation is often delayed and plants are more susceptible to winter injury. Bushes with less than 1.7% leaf nitrogen generally are less vigorous and productive. Leaf nitrogen levels are often highest during heavy crop years or dry years. Levels decrease throughout the season, so samples collected earlier in the season will contain higher levels of nitrogen than leaves sampled later.

**Phosphorus** Although blueberries in the field seldom respond to phosphorus applications or show symptoms of phosphorus deficiency, supplements may be necessary when leaf levels fall below 0.08%. Leaf phosphorus concentrations are highest very early in the season and lowest at harvest time. Levels are not greatly affected by yearly variations in crop load or moisture supply.

**Potassium** Potassium fertilizers should be applied if leaf potassium levels fall below 0.35%. There is some evidence that blueberry bushes containing up to 0.5% potassium may benefit from supplements, but this is not always true. This confusion is likely the result of the strong influence that crop load has on leaf potassium levels. Since fruits accumulate relatively large amounts of potassium, leaf levels are always lower when bushes are bearing heavily, and high when a light crop is present. Leaf potassium levels between 0.35 and 0.40% are adequate if bushes are carrying a full crop of fruit. The same levels observed during a light crop year might be too low. Too much potassium in blueberries inhibits magnesium uptake; leaf levels above 0.9% are excessive.

**Calcium** Although blueberries are seldom deficient in calcium, leaf calcium levels may be useful as a gauge of soil pH. Leaf calcium levels increase with soil pH. Levels can be strongly influenced by crop load (high calcium when crop load is heavy) and nitrogen fertilization (low leaf calcium in vigorous, heavily fertilized plants), so calcium levels may vary from year to year.

**Magnesium** A deficiency level of 0.1% magnesium is generally used for blueberry leaves; however, there have been reports of magnesium deficiency symptoms on bushes containing as high as 0.2% magnesium. It is likely that bushes with higher leaf potassium levels may also have higher optimum magnesium levels. Excessive magnesium levels usually imply that the soil pH is too high.

**Iron** Although iron deficiency is a widespread problem in blueberries, leaf iron levels have limited value in diagnosing this problem. Symptoms usually develop when leaf iron approaches 60 parts per million, but may also appear on plants containing considerably higher leaf iron. In other cases, plants containing less than 60 ppm iron may exhibit no symptoms of deficiency. Iron deficiency in leaves is usually a result of high soil pH rather than deficient levels of iron in the soil.

**Other nutrients** General sufficient ranges and tentative deficient and excessive levels are provided for boron, copper, manganese, sulfur, and zinc (see table 6). These levels were compiled primarily from reported values in healthy plants and controlled studies on potted young plants. They are likely to change somewhat as more information becomes available.

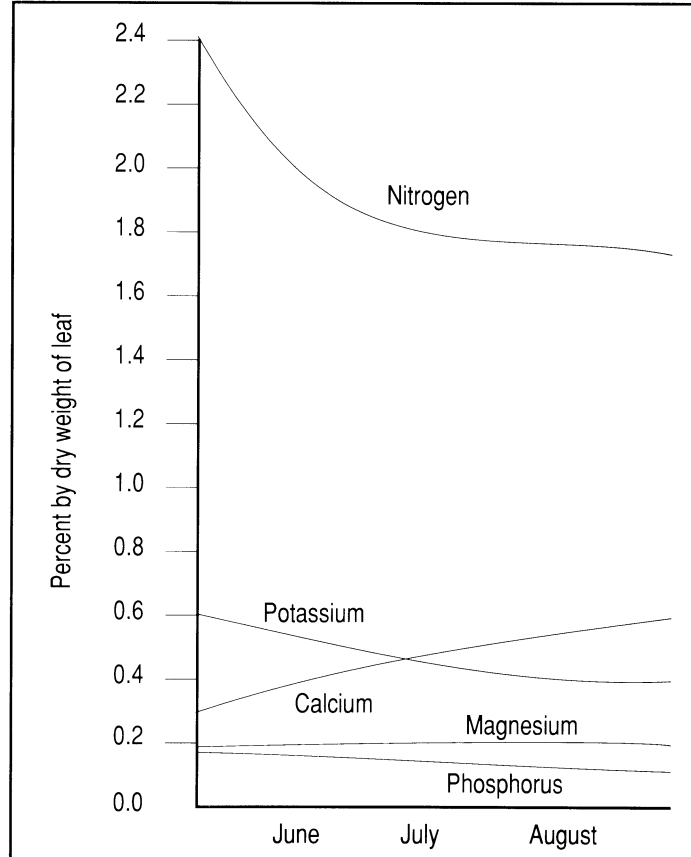

**Figure 7.** Seasonal fluctuations in leaf nutrient concentrations.

## Fertilizers and Rates

Fertilizers are materials that contain plant nutrients. There are several potential fertilizer sources for each nutrient. In choosing a fertilizer, consider the cost per unit of nutrient, nutrient release rate, and whether the material contains other nutrients which are needed. Most blueberry plantings require nitrogen applications each year (table 7), whereas other nutrients are generally applied only when a need arises. Common fertilizer sources for major nutrients are listed in table 8 and micronutrient sources are given in table 9 (page 107). Organic sources of macronutrients can also be used on blueberries (tables 10–12, pages 108–109).

**Table 7.** Recommended annual rates of nitrogen (pounds per acre) in a typical northeastern or midwestern blueberry planting.

AGE (years)	UREA	AMMONIUM SULFATE	ACTUAL NITROGEN
8	145	310	65
7	120	260	55
6	100	215	45
5	80	170	35
4	60	130	27
3	45	95	20
2	35	75	15

For greatest efficiency, apply fertilizer in two applications between bud break and 6 weeks after. Recommended nitrogen rates are about 30% higher in southern growing areas, and fertilizers should be split 3 times over a 12-week period after bud break. In the Pacific Northwest, rates are 50–100% higher.

Nitrogen sources include ammonium sulfate, ammonium nitrate, urea, or other organic sources (tables 8 and 12). Nitrogen fertilizers which supply nitrogen in the ammonium form are preferred over those supplying nitrogen as nitrate, because blueberries are sensitive to nitrate (photo 155). Generally, urea is the best choice if the soil pH is less than 5.0. Urea is high in nitrogen (46% nitrogen) and usually the least expensive source per unit of nitrogen. It also helps control mummy berry disease (see pages 88–89) when applied in spring. If urea is applied to a moist soil surface when the air temperature is warm, then much of the nitrogen could be lost to the atmosphere through volatilization. Apply urea during cool, rainy weather or irrigate after application.

**Table 8.** Fertilizer sources of major nutrients.<sup>1</sup>

FERTILIZER	PERCENT BY WEIGHT OF FERTILIZER				
	N	P <sub>2</sub> O <sub>5</sub>	K <sub>2</sub> O	Ca	Mg
Ammonium sulfate	20.5	—	—	—	—
Concentrated superphosphate (or TSP)	—	46	—	—	—
Diammonium phosphate (DAP)	17	50	—	—	—
Dolomitic limestone	—	—	—	15–20	10–15
Gypsum	—	—	—	22	—
Limestone	—	—	—	30	—
Magnesium sulfate (Epsom salts)	—	—	—	—	10
Monoammonium phosphate (MAP)	11	48	—	—	—
Potassium-magnesium sulfate (Sul-Po-Mag)	—	—	22	—	11
Potassium sulfate	—	—	50	—	—
Superphosphate (OSP)	—	20	—	—	—
Urea	46	—	—	—	—

<sup>1</sup> Salt indexes and acid equivalencies are reported in appendix 2.

If the soil pH is somewhat high (above 5.0), ammonium sulfate is the best choice. Although urea and ammonium sulfate tend to decrease pH, ammonium sulfate is the more acidifying of the two. If complete fertilizers (containing nitrogen, phosphorus, and potassium) or blends are used, make sure the majority of the nitrogen is in the ammonium form. Urea will form ammonium in the soil so it is considered an ammonium source.

Most mature plantings need 50 to 70 pounds of nitrogen per acre annually, but rates must be adjusted for each site. In the Pacific Northwest where the growing season is longer and the risk of winter injury is less, up to 100 pounds per acre is recommended. Plantings on sandy soils low in organic matter will need higher rates and those on heavier soils high in organic matter require lower rates. Plantings mulched with sawdust or wood chips may need double these rates because most mulching materials make the nitrogen temporarily unavailable (see chapter 6).

Apply nitrogen at bud break in the spring. Blueberries are shallow rooted and can absorb nitrogen quickly. Fertilizer applied in the late fall, winter, or early spring may be leached out of the root zone before plants can use it. Multiple applications will often increase the efficiency of nitrogen use, particularly on sandy soils which are more prone to leaching. Split the annual rate to 2 or 3 portions and apply these between April and June. Do not fertilize plants late in the summer as this stimulates growth that is subject to winter injury.

Some growers supplement annual soil applications of nitrogen with foliar sprays during the season. Supplemental nitrogen sprays may be beneficial on nitrogen-deficient bushes, but bushes receiving appropriate soil applications of nitrogen are unlikely to respond to sprays.

Phosphorus can be applied if needed in a complete fertilizer or in one of the sources listed in table 8. Sources containing only phosphorus can be applied anytime, whereas sources containing nitrogen should be applied only at bud break. Use rates recommended on soil test or leaf analysis reports, which are usually 75 to 100 pounds of  $P_2O_5$  per acre.

If soil tests or leaf analyses indicate a need for potassium, use potassium sulfate. Use Sul-Po-Mag if magnesium is also needed. Potassium chloride (muriate of potash) is used by some growers because it is less expensive, but blueberries are sensitive to the chloride in this material. If high rates are used or the material is applied to young plants or not spread uniformly, damage can occur. Rates of 50 to 100 pounds of  $K_2O$  per acre will correct most shortages. Apply potassium at any time of year. Excess potassium can interfere with magnesium uptake, so it should not be applied unless a foliar analysis indicates a deficiency. Potassium is dependent on adequate soil moisture for uptake.

If magnesium is needed, consider the soil pH when choosing the proper source. Dolomitic lime is the cheapest, but should only be used if soil pH is less than 4.5. If magnesium is needed but pH is above 4.5, use magnesium sulfate (Epsom salts) or Sul-Po-Mag. These sources generally do not change soil pH. Apply enough of these materials to supply 50 pounds of magnesium per acre.

If soil tests indicate calcium is needed, soil pH is nearly always too low. Apply limestone or dolomitic limestone at recommended rates (usually 1,000 to 2,000 pounds per acre). Occasionally calcium levels may be low when pH is in the proper range. Gypsum is a good calcium source in this situation because it does not change pH.

Micronutrient deficiencies are seldom seen on blueberries unless the soil pH is too high. Symptoms of iron deficiency are usually the first indicator of improper soil pH, although pH also influences how much boron, copper, manganese, molybdenum, and zinc is available to plants. For this reason, most micronutrient problems can be corrected permanently by simply adjusting soil pH to the proper range.

**Table 9.** Suggested micronutrient sources and application techniques.

NUTRIENT	PRODUCT	METHOD	RATE
Boron	Solubor (20% B)	Foliar	1.5 lb/acre
	Borax (11% B)	Ground	5 lb/acre
		Ground	10 lb/acre
Copper	Copper chelate	Foliar	Label rates
Iron	Iron chelate	Foliar	Label rates
Manganese	Manganese chelate	Foliar	Label rates
	Manganese sulfate (32% Mn)	Foliar	2 lb/acre
Zinc	Zinc chelate	Foliar	Label rates

Apply foliar sprays when leaves are present. Use 100–200 gallons water per acre.  
Apply ground sprays at any time. Use 20–50 gallons water per acre.

Micronutrient applications may be needed to supply plants until soil pH responds to corrective measures, or when shortages are the result of low soil supply rather than improper pH (table 9). When using micronutrients on blueberries, keep in mind that soil applications of iron, manganese, or copper are seldom helpful on high-pH soils because the nutrients rapidly form precipitates and are then unavailable for use by the plant. Soil applications of iron, for example, seldom benefit iron-deficient plants. Also, micronutrients should not be applied unless there is a clear indication from leaf

analyses or symptoms that the plants are deficient. Excessive applications of micronutrients (boron, in particular) can be as damaging as deficiencies (photo 153).

**Nutrient Release Rate**

Fertilizer delivery methods and materials differ in the rate at which their nutrients become available to the blueberry plant. Foliar nutrient sprays can rapidly provide the plant with nutrients, but only small amounts can be applied at any one time without injuring the leaves. For example, more than 5 pounds of urea in 100 gallons of water per acre can cause phytotoxicity; this amount only provides 2.5 pounds of actual nitrogen per acre, assuming all is completely absorbed by the plant. However, with foliar applications, some solution misses the target and absorption is not complete, so foliar applications usually provide less than 1 pound of nutrient per acre. This small amount may not be physiologically significant. For these reasons, foliar applications of micronutrients are most appropriate, since they are required only in small amounts. Foliar macronutrient applications (of N, P, and K) have not been shown to be effective in blueberry.



Inorganic fertilizers generally provide the plant with a rapid release of nutrient. Since the plant may not be able to capture a year's worth of nutrient at one time, applications are often split over several months. Fertigation is a method of delivering small amounts of nutrients regularly and efficiently to blueberry plants (see appendix 2).

Organic fertilizers have a slower release rate than most inorganic fertilizers and may contribute to the fertilizer requirement over several growing seasons. A single application of the annual requirement may be recommended if nutrients will be released slowly over the growing season.

Other factors affect the nutrient release rate. Finely ground fertilizers have a faster release rate than coarse materials. Some fertilizers are intentionally coated with materials that slow the release rate. Soil chemistry and soil microorganisms also influence nutrient availability and release, as will temperature and moisture. Growers should consider the relative availability of the nutrients in their fertilizers to obtain the desired plant response.

**Table 10.** Natural deposits that can be used as fertilizers.

MATERIALS	PERCENT BY WEIGHT OF MATERIAL <sup>1</sup>			RELEASE RATE
	N	P <sub>2</sub> O <sub>5</sub>	K <sub>2</sub> O	
Colloidal phosphate	0	25	0	Slow
Granite Meal	0	0	3–5	Very Slow
Greensand	0	1.35	4–9.5	Very Slow
Kaolinite	0	0	12	Medium
Rock Phosphate	0	20–32	0	Very Slow
Sodium Nitrate	16	0	0	Rapid

<sup>1</sup> The percentage of plant nutrients is highly variable and it differs with place of origin. The availability of plant food from natural deposits depends largely upon the fineness to which these materials are pulverized.

Source: "Organic Gardening Culture and Soil Management," The Pennsylvania State University.

**Table 11.** Organic materials that can be used to decrease soil acidity.

MATERIAL	LIME EQUIVALENT <sup>1</sup>
Clam shells (finely ground)	50% CaO
Clam shells (75% shall pass a 100-mesh sieve)	35–42% CaO
Oyster shells	43–50% CaO
Wood ashes	32% CaO
Dolomitic limestone	15% MgO + 35% CaO
Calcitic limestone	45–50% CaO

<sup>1</sup> Multiply % CaO by 1.8 to obtain % lime equivalent of CaCO<sub>3</sub>.  
 Multiply % MgO by 2.5 to obtain % lime equivalent of CaCO<sub>3</sub>.

Source: "Organic Gardening Culture and Soil Management," The Pennsylvania State University.

**Table 12.** Nutrient content of organic materials used for macronutrient supplementation.

MATERIALS	PERCENT BY WEIGHT OF MATERIAL <sup>1</sup>			RELEASE RATE
	N	P <sub>2</sub> O <sub>5</sub>	K <sub>2</sub> O	
Animal Tankage (dry)	7	10	0.5	Medium
Bone Meal (raw)	2–6	15–27	0	Slow
Bone Meal (steamed)	0.7–4.0	18–34	0	Slow–medium
Castor Pomace	5	1.8	1	Slow
Coca Shell Meal	2.5	1.0	2.5	Slow
Compost (not fortified)	1.5–3.5	0.5–1.0	1.0–2.0	Slow
Cottonseed Meal (dry)	6	2.5	1.7	Slow–medium
Dried Blood (dry)	12	1.5	.57	Medium–rapid
Fertrell-Blue Label	1	1	1	Slow
Fertrell-Gold Label	2	2	2	Slow
Fertrell-Super	3	2	3	Slow
Fertrell-Super N	4	3	4	Slow
Fish Meal (dry)	10	4	0	Slow
Fish Scrap (dry)	3.5–12	1–12	.08–1.6	Slow
Garbage Tankage (dry)	2.7	3	1	Very slow
Guano (bat)	5.7	8.6	2	Medium
Guano (Peru)	12.5	11.2	2.4	Medium
Kelp <sup>2</sup>	.9	.5	4–13	Slow
Manure <sup>3</sup> (fresh)				
Cattle	.25	.15	.25	Medium
Horse	.3	.15	.5	Medium
Sheep	.6	.33	.75	Medium
Swine	.3	.3	.3	Medium
Poultry—75% water	1.5	1	.5	Medium–rapid
Poultry—50% water	2	2	1.0	Medium–rapid
Poultry—30% water	3	2.5	1.5	Medium–rapid
Poultry—15% water	6	4	3	Medium–rapid
Marl	0	2	4.5	Very slow
Milorganite (dry)	5	2–5	2	Medium
Mushroom Compost	0.4–0.7	0.6	0.5–1.5	Slow
Peat and Muck	1.5–3.0	.25–.50	1.0	Very Slow
Sawdust	4	.2	.4	Very slow
Sewage Sludge (activated, dry)	2–6	3–7	0–1	Medium
Sewage Sludge (digested)	1–3	0.5–4	0–.5	Slow
Soybean Meal (dry)	6.7	1.6	2.3	Slow–medium
Tanbark <sup>4</sup>	0	1.5	2	Very slow
Tobacco Stems (dry)	2	0.7	6.0	Slow
Urea <sup>5</sup>	42–46	0	0	Rapid
Wood Ashes <sup>6</sup>	0	1–2	3–7	Rapid

Some of the materials may not be available because of restricted sources.

<sup>1</sup> The percentage of plant nutrients is highly variable, and with some materials, mean percentages are listed.

<sup>2</sup> Contains common salt, sodium carbonates, sodium and potassium sulfates.

<sup>3</sup> Plant nutrients available during year of application. Varies with amount of straw and method of storage.

<sup>4</sup> Contains calcium.

<sup>5</sup> Urea is an organic compound, but some organic growers consider it unacceptable because it is synthetically produced.

<sup>6</sup> Potash content depends on the tree species burned. Wood ashes are alkaline, containing approximately 32% CaO.

Source: "Organic Gardening Culture and Soil Management," The Pennsylvania State University.

## Chapter 12

# WATER MANAGEMENT

Water is essential to producing a profitable blueberry crop. Fortunately, in the cool humid climate of the Northeast, upper Midwest, and parts of the Pacific Northwest, water is relatively abundant. For example, approximately 40 inches of precipitation occur annually in the Northeast, and since only 36 inches of water is lost through evapotranspiration in an average year, this region generally enjoys an overall water surplus. In many situations, this water surplus can lead to problems with soil drainage. In southern regions with a longer growing season and higher evapotranspiration, water deficits usually develop. In all blueberry growing areas, the inconsistency of rainfall leads to both excess and deficit water conditions many times during the life of a blueberry planting. Supplying sufficient water and removing excess water should be goals of the blueberry grower.

Problems associated with water deficits can occur even during years of normal abundant rainfall. While precipitation is distributed evenly throughout the year in much of the Northeast, almost all the water lost through evapotranspiration occurs during the summer months. For a central New York location, July has the highest water demand, but very low average precipitation (figure 8). The distribution of precipitation is not well timed in relation to water need. The importance of water to a growing crop and the tremendous uncertainty of rainfall over time and locations make water management an important factor for blueberry production.

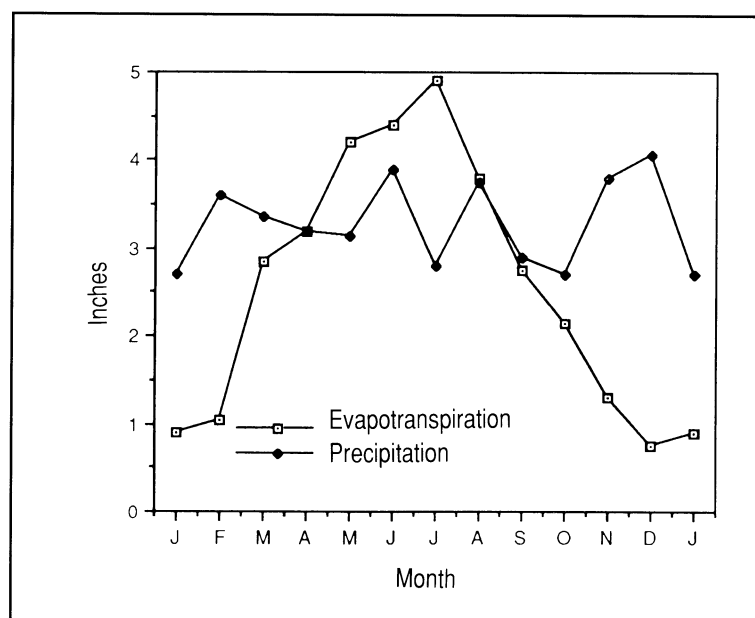

**Figure 8.** Average monthly precipitation and potential evapotranspiration at Aurora, NY, based on 5 years of data.

Proper water management requires an in-depth knowledge of within-season rainfall patterns and frequencies. Climatic data are generally available for locations throughout North America (figures 9–10). On-site rainfall measurement is recommended to ensure site-specific rainfall distribution data.

A detailed rainfall analysis, together with plant, soil, and other climatic (mainly temperature) information, is needed for growers to choose the best set of cultural and water management practices for blueberry production. Growers must consider water management during the initial site selection process to minimize future problems. In many cases, the availability of water for irrigation determines whether a site is suitable for blueberry production.

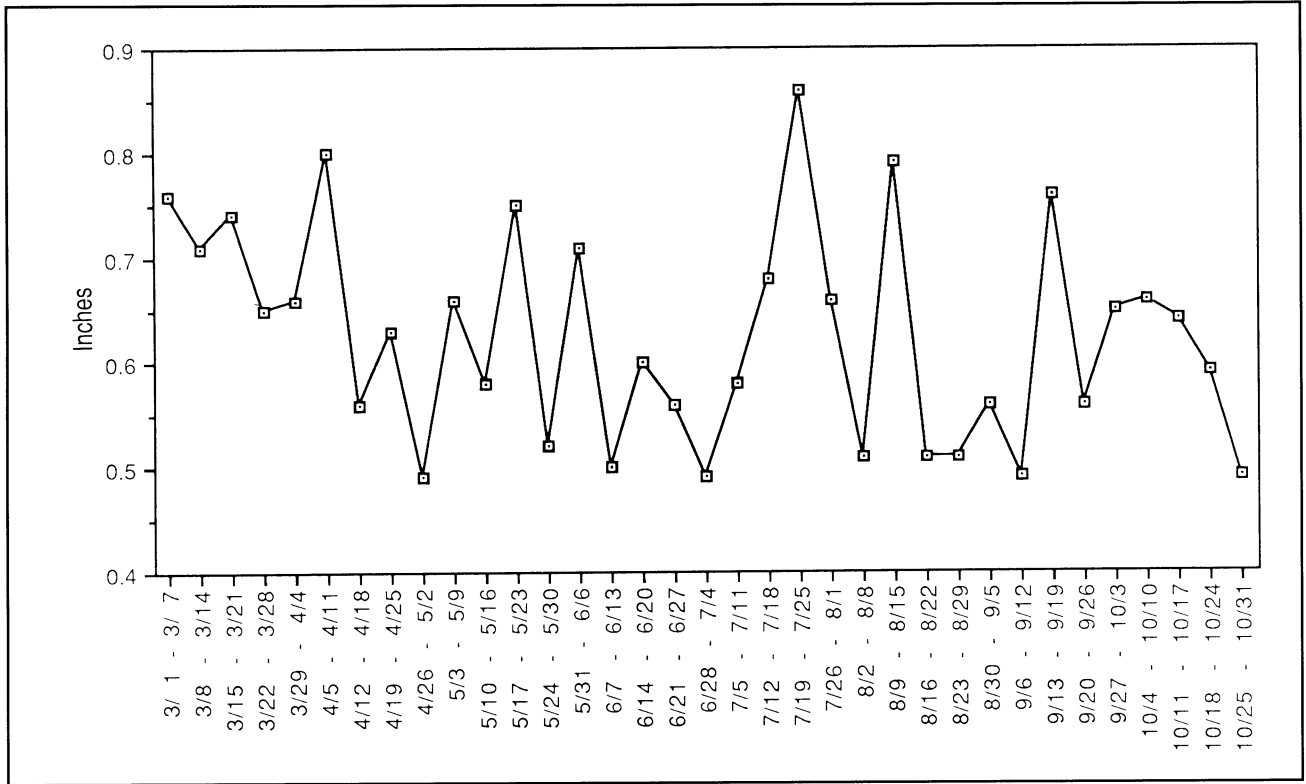

**Figure 9.** Average weekly rainfall at Rochester, NY, based on 30 years of data.

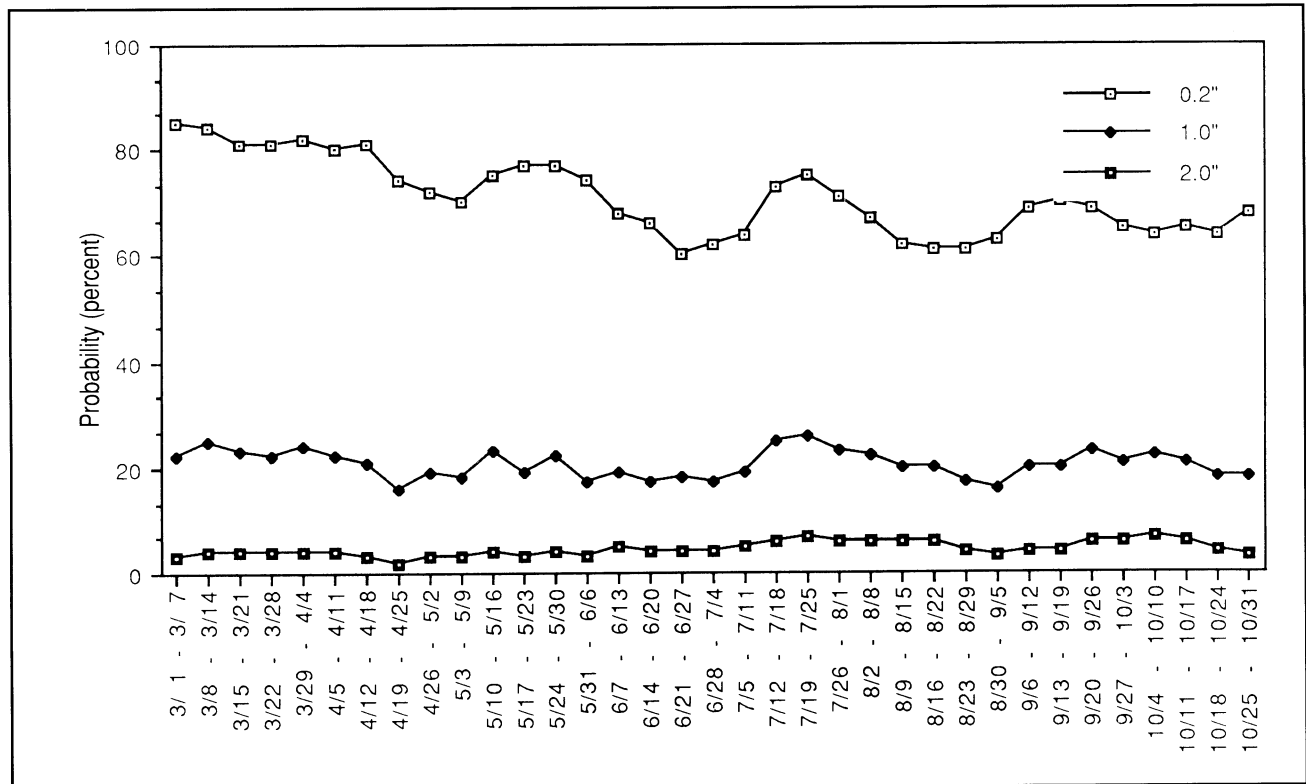

**Figure 10.** Probabilities of receiving at least 0.2, 1.0, and 2.0 inches of precipitation for the week indicated at Rochester, NY.

## **Excess-Water Considerations**

---

Blueberries are often associated with swamps or bogs, and believed to be tolerant of wet conditions. In bogs, however, blueberries grow on hummocks or other areas that rise above the level of the water. They are found in wetlands, not because they require wet conditions, but because they can compete effectively in these nutrient-poor environments with other plants. Blueberries grow best in moist but not saturated soils.

Most horticultural crops cannot tolerate excessively wet soil conditions, especially in warm soils. Standing water or poorly aerated (waterlogged) soil weakens the plant and encourages diseases. A lack of oxygen in waterlogged soils reduces respiration and can cause production of toxic substances which destroy root cells. In blueberries, waterlogged conditions during periods of rapid root growth (March through May, October through November) are especially detrimental. The above-ground symptoms of excessive water are similar to those produced by drought stress. Stressed plants wilt and develop abnormal leaf coloration.

Growers should not select sites with soil that is shallow, has a fine or clay texture, is poorly drained, or is at risk of flooding. Even if blueberries could tolerate these conditions, such sites are frequently muddy. Cultivating, spraying, and harvesting are difficult under these conditions.

The development of many wetland areas means that such lands are now protected by federal legislation. Before draining wet areas in a field, consult the Soil Conservation Service for an update of the current state and federal definitions of a wetland and the regulations regarding modification. Farmers who have modified wetland habitats without permission have had to pay substantial penalties.

Although water tables in poorly drained soils are highest during the winter and early spring months when most plants are dormant, root damage and disease can still occur at those times. During the summer months, the water table in poorly drained soils may be below the root zone. However, if supplemental irrigation is used and an unexpected rain occurs, water levels can rise quickly, causing soil saturation and subsequent plant damage.

Ideally, growers should select sites that are gently sloping, with medium- to coarse-textured soils which are moderately to well drained to minimize problems with excess water. Most Soil Conservation Service offices have detailed soil surveys of each county that are useful for site selection. Land slopes of 2 to 3% provide good surface water and air drainage which help prevent frost damage. Soil erosion is a potential hazard on slopes steeper than 3%. Terraces, water diversions, and grassed waterways may be needed to manage surface water and reduce erosion on steep slopes.

Practices for correcting excess water problems include reshaping the surface topography or constructing artificial drainage systems. The method used will depend on the source of the water problem, site topography, soil type, cost, and crop requirements (table 13).

Raised beds (ridges) and surface drainage systems can prevent water from

**Table 13.** Water source factors and their influence on drainage systems.

WATER TABLE FACTORS	DRAINAGE SOLUTION
1. Water table fluctuates with irrigation cycle.	<ul style="list-style-type: none"> <li>• Improved water management may preclude drain system.</li> <li>• Tube drain grid system will handle excess irrigation water.</li> </ul>
2. Water table fluctuates with rainfall.	<ul style="list-style-type: none"> <li>• Better surface drainage is needed.</li> <li>• Tube drain system should be considered.</li> </ul>
3. Artesian pressure from deep water bearing aquifers.	<ul style="list-style-type: none"> <li>• Drainage relief well or deep tube systems are needed.</li> </ul>
4. Seepage from canal or reservoir.	<ul style="list-style-type: none"> <li>• Lining of canal or reservoir to prevent seepage may eliminate the drainage problem.</li> <li>• Interceptor drain tube or open drain near canal or reservoir.</li> </ul>
5. Seepage from outcrops or along toe of bench.	<ul style="list-style-type: none"> <li>• Interceptor drain tube or open drain.</li> </ul>
6. Seepage from leaking artesian wells.	<ul style="list-style-type: none"> <li>• Seal or cap well to prevent uncontrolled flow.</li> <li>• Dike off artesian flow and carry away in deep open drain.</li> </ul>
7. Pondered water at lower ends of fields.	<ul style="list-style-type: none"> <li>• Proper leveling may eliminate pond areas.</li> <li>• Pump back drain systems.</li> <li>• Proper tail water waste ditches.</li> </ul>
8. Pondered water in fields.	<ul style="list-style-type: none"> <li>• Proper grading for even distribution.</li> <li>• Surface field drains.</li> </ul>
9. Drainage water of poor quality.	<ul style="list-style-type: none"> <li>• Drainage waste water must be disposed of so as to eliminate contamination downstream (irrigated areas only).</li> </ul>
10. Drainage water of good quality.	<ul style="list-style-type: none"> <li>• Drainage waste water can be reused or mixed with fresh water for reuse downstream.</li> </ul>
Consult the Soil Conservation Service for information on wetland regulations before installing drainage systems.	
Source: Donnan, W. W. and G. O. Schwab. 1974. "Current Drainage Methods in the USA." Agronomy Monograph 17, American Society of Agronomy. Madison, WI. p. 98.	

forming ponds and are generally not too costly. Subsurface drainage systems, where tube drains or tiles are buried in the soil, are used mainly for lowering water tables, although they can be used for irrigation. For flat areas that flood often, a combination of water management practices is often required. These may include open channel excavations, or even diking and pumping, in combination with additional artificial drainage measures. Corrective drainage can be costly, especially on the clay soils or in areas with frequent flooding. Furthermore, various wetland regulations and drainage water laws may prohibit some drainage methods. The highest priority is to select sites that will have few or no excess water problems.

## **Deciding to Irrigate**

Several studies have shown that the benefits of irrigating fruit crops include higher yields, larger fruit size, and more marketable fruit. In hot, dry climates, crop performance with and without irrigation is easily com-

pared, and a return on investment can quickly be determined. In cooler, moist climates, no crop benefit may be obvious in years when precipitation is distributed adequately. As a result, the amount of return on the irrigation investment is more difficult to determine. However, even moist climates occasionally experience droughty periods, and irrigation may prove critical, especially if plants are very young.

The need for irrigation depends on several factors, including the frequency and duration of drought periods during critical plant growth stages, crop rooting and drought tolerance characteristics, and soil water-holding characteristics.

For high-value crops, irrigation is beneficial even in humid climates. For example, in the Northeast region, the average number of days between significant rains is 5. In one out of every two years, a 10- to 15-day period without rainfall is likely to occur. As a result, just one application could provide significant yield benefits to blueberries in at least half of the production years, particularly if water stress occurs during blossom and fruit set. Periods of 20 to 30 days without significant rainfall may occur 2 or 3 times every 20 years somewhere in this region. A drought lasting this long during the prime growing season would result in catastrophic yield losses! In the upper Midwest, the average number of days between rains is 6 or 7 and the drought frequency is greater. In the lower Midwest and the South, significant periods of drought occur nearly every year.

**Table 14.** Typical water-holding capacity for various soils.

TEXTURE	WATER-HOLDING CAPACITY (Inches of water per inch of soil)
Sand	0.05
Fine sand	0.08
Sandy loam	0.11
Loam	0.16
Silt loam	0.18
Clay loam	0.19
Silty clay	0.20
Clay	0.22

Blueberries have shallow root systems that cannot use water stored deep in the soil. As a result, blueberries grow best where the soil has a high water-holding capacity. Information about soil water-holding capacity is generally available in soil surveys. Soil texture is another clue to water-holding capacity (table 14). In general, sandy soils hold the least amount of water. These soils must be irrigated more frequently and with less water per application than soils with a high percentage of silt and clay.

Crop rooting depth and the soil water-holding capacity are used together to determine the total water-holding capacity of the rooting volume.

The capacity of the rooting volume is important in scheduling irrigation.

The following example shows how to determine the water-holding capacity of the rooting volume and how to use this information to schedule irrigations. In this example, assume that blueberries are planted on a sandy loam soil. Using a rooting depth of 1.5 feet, the total water-holding capacity of the rooting volume is 18 inches of soil times 0.11 inch of available water per inch of soil depth (table 14), which equals 2 inches of total water-holding capacity. The total water available in the rooting volume should not drop below 50% of the total water-holding capacity. This assures easy access to water by the roots and prevents drought stress. Using this limit in the example, the total water available should not fall below 1 inch, which is half of the 2-inch total water-holding capacity. A blueberry plant growing vigorously in

**Table 15.** Monthly average potential evapotranspiration or peak use rate of water demand for July and August at various locations in the U. S.

STATE	LOCATION	AVERAGE PEAK USE RATE Inches/Day	STATE	LOCATION	AVERAGE PEAK USE RATE Inches/Day
Arkansas	Fort Smith	0.24	Massachusetts	Boston	0.24
	Little Rock	0.23		Blue Hill Observatory	0.23
	Texarkana	0.22		Nantucket	0.20
California	Bishop	0.45		Pittsfield	0.22
	Eureka	0.16		Worcester	0.22
	Fresno	0.39	Michigan	Alpena	0.20
	Mt. Shasta	0.39		Detroit	0.25
	Oakland	0.22		Escanaba	0.20
	Red Bluff	0.43		Flint	0.21
	Sacramento	0.36		Grand Rapids	0.24
	San Francisco	0.26		Lansing	0.24
Stockton	0.38	Marquette		0.19	
Connecticut	Bridgeport	0.22		Muskegon	0.22
	Hartford	0.21	Minnesota	Duluth	0.21
	New Haven	0.20		International Falls	0.20
Delaware	Wilmington	0.22		Minneapolis-St. Paul	0.22
Idaho	Boise	0.38		Rochester	0.22
	Lewiston	0.35		Saint Cloud	0.21
	Pocatello	0.36	Missouri	Columbia	0.23
Illinois	Cairo	0.21		Kansas City	0.25
	Chicago	0.24		St. Joseph	0.22
	Moline	0.22		St. Louis	0.23
	Peoria	0.22		Springfield	0.23
	Springfield	0.23	New Hampshire	Concord	0.20
Indiana	Evansville	0.22		Mt. Washington Obs.	0.15
	Fort Wayne	0.22	New Jersey	Atlantic City	0.22
	Indianapolis	0.23		Newark	0.23
	South Bend	0.23		Trenton	0.23
Iowa	Burlington	0.22	New York	Albany	0.20
	Des Moines	0.22		Binghamton	0.17
	Dubuque	0.21		Buffalo	0.22
	Waterloo	0.19		New York	0.23
Kentucky	Lexington	0.23		Rochester	0.21
	Louisville	0.23	Syracuse	0.21	
Maine	Caribou	0.17	North Carolina	Asheville	0.18
	Portland	0.20		Cape Hatteras	0.20
Maryland	Baltimore	0.25		Charlotte	0.20
				Greensboro	0.20
				Raleigh	0.20
			Wilmington	0.21	



**Table 15**—continued

STATE	LOCATION	AVERAGE PEAK USE RATE Inches/Day	STATE	LOCATION	AVERAGE PEAK USE RATE Inches/Day	
Ohio	Akron	0.22	Tennessee	Bristol	0.19	
	Cincinnati	0.23		Chattanooga	0.21	
	Cleveland	0.24		Knoxville	0.22	
	Columbus	0.22		Memphis	0.22	
	Dayton	0.24		Nashville	0.23	
	Sandusky	0.24		Vermont	Burlington	0.21
	Toledo	0.25			Virginia	Lynchburg
	Youngstown	0.21	Norfolk	0.20		
Oklahoma	Oklahoma City	0.28	Richmond	0.21		
	Tulsa	0.25	Roanoke	0.22		
Oregon	Astoria	0.15	Washington	Olympia	0.20	
	Eugene	0.24		Seattle	0.21	
	Medford	0.33		Yakima	0.33	
	Pendleton	0.38	West Virginia	Charleston	0.20	
	Portland	0.22		Elkins	0.15	
	Salem	0.25		Parkersburg	0.20	
Pennsylvania	Allentown	0.21	Wisconsin	Green Bay	0.20	
	Erie	0.21		La Crosse	0.21	
	Harrisburg	0.22		Madison	0.22	
	Philadelphia	0.22		Milwaukee	0.22	
	Pittsburgh	0.19				
	Williamsport	0.21				
Rhode Island	Block Island	0.19				
	Providence	0.21				

summer can evapotranspire more than 0.25 inch per day, depending on location (table 15). With 1 inch of water available in the rooting volume and approximately 0.25 inch being used per day, it takes 4 days for the blueberry plant to use this stored soil water. Since the average time between rains is 5 days, irrigation is highly desirable for this soil and site under peak use conditions. In general, blueberries grown on light soils with low water-holding capacities will benefit from irrigation most years, even in the humid regions.

## **Water Supply Considerations**

An adequate and dependable supply of good-quality water must be available at a reasonable cost throughout the growing season if irrigation is to be successful and cost-effective. The water source should be as close as possible to the area to be irrigated to minimize the pumping and supply line cost. Large ponds, lakes, streams, springs, ground water, municipal water, and wastewater are all potential water sources.

The legal right to withdraw large quantities of water for irrigation must also be verified. Water rights in the eastern United States are called “riparian” or landowner’s rights because anyone is entitled to use any water associated with land ownership. However, a riparian owner’s rights are not absolute and are subject to reasonable use interpretations. In some western states, water is only available through appropriative rights. In some areas, permits are required before surface water or ground water can be withdrawn for irrigation.

In the arid states, the demand for water exceeds the supply. The supply of surface water varies each year, as it is determined by mountain snowfall in the previous year. Over time, a system of priority use has developed; those higher on the priority list divert their appropriation before those lower on the list. Water diversions continue until the stream flow reaches the minimum allowable rate. For ground water in arid states, there is much more variability in the methods used to determine allowable withdrawals. In all cases, a construction of a well requires a permit.

Water sources must be able to provide water as often as needed. Since stream flow and shallow ground water sources are strongly influenced by climate, they may not provide enough water during the dry part of the year when irrigation is needed most. Sometimes municipal water systems allow connections for irrigation purposes. However, this option may be expensive if water-use prices are high or if large areas are to be irrigated. Furthermore, if the municipality enforces water rationing, it may not permit irrigation during drought times. Although wastewater sources are generally of poor quality and the amount of water available may not fulfill crop needs, wastewater sources are being increasingly used for irrigation.

The irrigation water supply must be large enough to replace the moisture taken from the rooting volume. Since irrigation is not 100% efficient, the water supply rate must be higher than the crop water use rate. Crop water requirements depend on climate, plant type, and soil moisture availability; actual water use changes over time and is difficult to predict. Therefore, water supply systems are generally evaluated using two criteria, seasonal water demand and daily water demands. The water supply must be sufficient to satisfy the requirements of the irrigation system and must supply enough water to meet crop needs.

### **Seasonal Water Demand**

Seasonal water demand is the average amount of water a crop will need for the entire growing season. Growers find this amount useful for sizing water supply systems where water is stored for irrigation, such as in ponds. For blueberries, 20 to 25 inches of water is a typical seasonal water demand; the demand tends to be higher in the warmer coastal areas. For a 30-day drought period, or a growing season with 15 inches of rainfall, an additional 5 to 10 inches of water would be required to meet the seasonal demand. Growers should store from 3 to 12 acre-inches of water for each acre irrigated during the season. An acre-inch is a unit of volume equal to one inch of water depth over an entire acre and is equivalent to 27,154 gallons of water.

Because irrigation systems are not 100% efficient, the rule of thumb for sprinkler systems is to store 40,000 gallons for each 1 acre-inch application. For example, a 5-inch seasonal demand would require 200,000 gallons per acre (5 inches x 40,000 gallons per acre-inch) if irrigated with an overhead sprinkler system. To irrigate a 20-acre parcel, a total of 4 million gallons (200,000 gallons per acre x 20 acres) should be available in storage. To store this water, a grower would require a 200- by 200-foot pond that can store water to a depth of 13.4 feet (1 cubic foot = 7.48 gallons).

### **Daily Peak Use Rate**

At some time during the growing season, environmental conditions and crop characteristics will require peak water-use rates. This peak use rate is another useful value for sizing water supply systems such as continually flowing springs, streams, wells, or municipal systems. Both the water supply and the irrigation system must be capable of supplying water at the daily peak use rate. Irrigation schedules based on the daily peak use assure that enough water is applied when needed. Climatic conditions determine the potential peak use rate, while various plant and soil factors adjust this potential to the actual peak use demand.

Average potential peak use rates are the highest in July and August (see table 15, pages 115–116). Since these rates represent long-term and monthly averages, any single daily peak use demand during this time period could be another 25% higher than average. To use the information in table 15, look up the location closest to the site to be irrigated, select the peak use rate value, and convert to the appropriate units of interest. For example, at Rochester, New York, the potential peak use rate averages 0.21 inch per day. To irrigate one acre to a depth of 0.21 inch during a 24-hour period will require 5,700 gallons (27,154 gallons per acre-inch x 0.21 acre-inch). This will require that an irrigation system supply 4 gallons per minute (gpm) to each acre irrigated. If these values are increased 25% to account for higher single daily peak uses in the months of July or August, the average peak use rate becomes 0.26 inch per day with a requirement of 5 gpm per acre irrigated. Thus, a spring, stream, well, or municipal source would have to supply 4 to 5 gpm continuously for each acre irrigated to meet the peak demand in the summer months.

Round-the-clock irrigation is not always possible and irrigation is never completely efficient, so growers must make adjustments. If a grower plans to irrigate only 10 hours a day with a sprinkler system operating at 75% efficiency, then the water supply must be capable of delivering approximately 13 to 16 gpm per acre to meet the average or single daily peak use rate, respectively. Irrigation time and system efficiencies are important factors in making maximum use of the available water supply.

When pumping from continuous water supply sources, the peak flow rate or discharge of the irrigation system cannot exceed the available supply. If the supply source is only marginally adequate, then the number of sprinklers which can be operated at the same time and, therefore, the number of acres irrigated at that time may be affected. Flow rates from many wells are limited (less than 100 gpm) because of the nature of the underlying geologic material. Many existing farm wells are inadequate for irrigation because

their diameters are not suited to high-capacity pumps, nor are they developed to yield the full aquifer potential. If continuous water supply sources are not large enough for direct pumping, additional surface storage facilities, such as ponds, can be added.

**Water Quality** In most blueberry production areas, water quality is good enough for irrigation purposes. However, quality should be a concern when a water source is assessed, including its physical, chemical, and biological constituents.

**Physical Constituents** Physical constituents refer to sand, silt, or other suspended materials in water. While the physical constituents are usually not damaging to fruit crops, they can create wear on the irrigation system. High sand content, for example, damages pumps and sprinklers, and suspended materials can clog drip systems. Surface water sources, such as ponds and rivers, usually contain more particles and should be evaluated carefully, especially if drip irrigation is being considered.

**Chemical Constituents** Chemical constituents refer to pH, the amount of dissolved material, the proportions of dissolved ions, and any organic compounds such as oil that are present in water. Water with a high concentration of total dissolved solids (more than 0.1%) may cause leaf burn and general growth inhibition in salt-sensitive fruit crops such as blueberries. Chloride, sodium, and boron are some constituents to which blueberries are sensitive. Such salinity problems generally are not severe, except in dry climates where rainfall is insufficient to wash and leach these materials off the plants and out of the root zone. Although generally not a problem, organic solvents or lubricants in the water can also damage plants. If water pH is high, it can be lowered with sulfuric acid to prevent nutritional problems in the field (Appendix 2).

**Biological Constituents** Biological constituents, such as bacteria and algae, are more often present in surface water sources. These constituents are not harmful to fruit crops themselves and can be controlled under most circumstances, but they can affect irrigation system performance. While most water quality problems encountered affect the performance of drip irrigation systems, adverse effects on fruit crop production rarely occur.

## **Selecting an Irrigation System**

---

Sprinkler, surface, trickle (drip), microjet, and below-surface irrigation are the five methods of applying irrigation water. Selecting the appropriate method for a site is dependent on land slope, soil water intake rates and water-holding capacity, water tolerance of the crop, and wind effects. Blueberries, which are sensitive to standing water, are not well suited to surface flooding irrigation. Also, blueberries are susceptible to fungal diseases, so sprinkler systems which wet the foliage and promote fungus growth may cause adverse affects. If water is not pure, mineral deposits can form on fruit. The uniformity of the sprinkler method is affected by wind.

Physical features play an important role in identifying irrigation options. For example, if an adequate water supply is not available at reasonable cost, irrigation may be impractical, limited in its use, or confined to drip systems. Slopes greater than 10% may prevent the use of some sprinkler systems.

Soils which absorb water slowly, tend to crust and seal, or are erosional should not be irrigated with sprinkler systems. Selection and cost-effectiveness of irrigation systems are also affected by crop height, row spacing, plant sensitivity to spray, the need for frost or other environmental protection, and the permanency of the crop.

Drip irrigation is usually the method of choice among blueberry growers where late spring frosts are uncommon. The system uses less water than overhead systems, the foliage is not wetted, field operations are not interrupted, and nutrients and acidifying amendments can be applied through the irrigation system.

Sprinkler irrigation systems with tall risers are used in frost-prone areas. Blueberries flower early in spring, often before the last frost. Unlike strawberry flowers, which open toward the sky, blueberry flowers tend to protect the delicate internal reproductive organs from damage. The urn-shaped flowers hang upside down, so the flowers are less prone to frost damage. Still, frost protection is warranted on sites with frequent spring freezes.

An important factor to consider is irrigation system efficiency. With sprinklers, for example, not all of the water sprayed into the air reaches the ground. Up to 15% is lost directly to evaporation; the actual amount will vary with droplet size, temperature, humidity and wind speed. Thus, if 1 inch of water is needed to replenish soil moisture for the crop, and the sprinklers are rated and spaced to apply 1 inch per hour, more than one hour would actually be needed to apply 1 inch of water to the soil. Drip systems are more efficient because they are not affected by evaporation. Under most on-farm circumstances, drip systems are rated at 90% efficient and sprinkler systems around 75% efficient. Nonuniform application and water losses in the distribution line may also affect efficiency.

### **Irrigation System Components**

Sprinkler and drip systems are the most widely used irrigation methods for blueberries. These systems have some common components, such as the pumping unit, control head, mainline and submain pipes, and laterals. The water-distribution hardware for both systems is similar. The difference is the physical characteristics of these components and the equipment which ultimately applies the water—either sprinklers or emitters.

#### ***Pumping Unit***

The pumping unit, which consists of a pump coupled to a power source, draws water from the supply source and pressurizes it for delivery through the irrigation system. A centrifugal pump or a submersible or deep well turbine pump may be used.

A centrifugal pump normally cannot be placed more than 20 feet above the water line. Pumps are available in a wide range of flow capacities and delivery pressures. Selecting the correct style of pump and the proper size will depend on site characteristics and the final irrigation system layout.

Pump size depends on the discharge or amount of water to be delivered at a given time (i.e., the number of sprinklers being operated simultaneously) and the pressure required to lift water and to operate the sprinklers or drip emitters. Since sprinklers usually have higher discharge and pressure

requirements, pumps for sprinkler systems are generally larger than those for drip systems. This is one reason that drip systems are more efficient than sprinkler systems.

Pumps can be driven by an electric motor or an internal combustion (IC) engine. For the best efficiency, electric motors and IC engines are coupled directly to the pump. However, pulley arrangements, gear boxes, and PTO hookups are often used. The total power requirement of the electric motor or IC engine will depend on the pump discharge, pressure requirement, internal pump efficiency, and coupling method. Pumps coupled directly to electric motors are the most efficient and the easiest to automate, but most pumping units can be automated and equipped with safety shutdown controls.

Although the pumping units must meet certain hydraulic requirements, several options are usually available to meet site requirements and growers' preferences. When growers can tie into municipal or household systems where water is already pressurized, no pumping unit is necessary. The primary concern is that the source is large enough.

**Control Head** The control head is the combination of items which controls, measures, or treats the water. Control heads can range from simple, manually operated heads with a single valve to quite sophisticated heads with automatic controllers and sensors, water meters, pressure regulators, filters, and nutrient or chemical injection equipment. Control heads for drip systems are often more complex because of the need for water filtration equipment. Automated equipment can be adapted to some systems and can sense soil moisture, start the irrigation system, and send water to the appropriate areas. The more complex and automated the control head and irrigation system, the greater the initial capital investment.

**Mainline and Submain Pipes** The mainline and, if necessary, submain pipes deliver water from the pump and control head to the laterals or other water distribution equipment. These pipes are usually classified as permanent, rigid and portable, or flexible and portable.

Permanent piping is usually made of galvanized steel or plastic (either rigid PVC or polyethylene). This piping is installed below ground, except for steel pipe which can be installed above ground. For perennial crops such as blueberries, permanent buried mainlines with hydrants spaced throughout the field offer several advantages, but they require high initial investment.

Rigid and portable piping is lightweight aluminum equipped with quick coupler fittings. Although moving pipe is labor intensive, portable piping systems offer flexibility and provide irrigation at a lower initial cost.

Flexible and portable pipe refers to conduits made with lightweight, durable rubber or synthetic compounds. These pipes are generally used with the self-propelled sprinklers.

Although friction losses decrease per unit length from steel to aluminum to plastic pipe, proper pipe diameter is a more important factor. Pipe size is determined according to the discharge requirement, the allowable flow velocity within the pipe, and the trade-off between the tolerable friction loss

and the total time of system operation in which that loss must be overcome. Since the total discharge requirements for sprinkler systems are higher than those for drip, pipe sizes are often larger with sprinkler systems.

Piping type—its material and whether it is permanent or portable—is generally not a major factor in achieving desired flow characteristics. Therefore, equipment selection depends mainly on grower preference and a trade-off between equipment and labor costs.

**Lateral Pipes** Lateral pipes deliver water from the mainline or submain to the sprinklers or drip emitters. They are of the same three general types as the mainline pipes but are usually smaller. Lateral pipe sizes are designed to minimize pressure losses so that sprinkler or emitter discharge at the far end of the lateral stays within 10% of the sprinkler or emitter discharge near the mainline to provide a uniform water application. Pressure is usually lower in drip laterals. Some drip system laterals combine the functions of a lateral and an emitter—these include porous pipe, perforated pipe, and multichamber tubes.

**Drip Systems** Compared to sprinkler nozzle sizes, drip system emitters have very small openings, usually pinhole size. Different emitters have different internal flow characteristics which determine how sensitive they are to pressure changes and particles in the water. A 150-200 mesh screen is normally required for water filtration.

Some emitters have larger orifices, are self-cleaning, or can be taken apart and cleaned. Periodic chlorine injections keep the system free of algae and bacterial slime. Acid injections, along with periodic flushing of the system, remove mineral buildup in some systems.

Emitters normally operate at pressures of 5 to 40 psi, with flow rates of 0.5 to 15 gallons per hour. Emitter spacing depends on the discharge rate and soil type because most of the water distribution is through the soil. The low pressure requirements of emitters result in more sensitivity to pressure losses along a lateral line or an elevation gradient. Pressure-compensating emitters may be necessary to achieve uniform water application on rolling terrain. Since the pressure and discharge requirements of emitters are usually smaller, the annual operating costs of these systems tend to be lower. Drip irrigation systems should be sized for the mature planting, and pressure-compensating emitters are preferable on rolling landscapes.

**Sprinkler Systems** The basic types of sprinklers include rotating sprinklers, stationary spray-type nozzles, and perforated pipe. Rotating sprinklers, such as the slowly rotating impact-driven sprinkler, are most commonly used. Fixed spray nozzles are becoming more popular, although they are most widely used in landscape applications. Perforated pipe is the simplest of sprinklers, consisting of a pipe with numerous holes through which the water sprays.

Rotating impact sprinklers come in many sizes and variations to meet various design conditions. Some sprinklers operate at pressures as low as 5 psi, while the large gun types require pressures exceeding 80 psi. Sprinkler discharge ranges from a few gallons of water per minute (gpm) to 1,000

gpm for a big gun. Wetted diameters can range from only a few feet to several hundred feet. When irrigating new plantings, avoid big guns with high pressures.

When selecting an irrigation system solely to provide water to the plants, use a high discharge rate so that evaporative loss and the time that foliage is wetted will be minimized, yet not so high as to cause puddling in the field. A system for frost protection should have a low discharge rate; 0.1 inch per hour is sufficient.

Pressure, discharge, and wetting diameter are the most significant characteristics of a sprinkler, but nozzle size, jet angle, wind, sprinkler overlap, and sprinkler rotation speed are also important. These characteristics determine water application rates, sprinkler spacings, and water droplet sizes. For uniform water application, sprinklers are generally spaced so that 50 to 60% of their wetted areas overlap. Since annual operating costs of irrigation increase with increasing pressure and discharge requirements, the large gun type sprinkler will require up to twice as much fuel or electric energy as smaller sprinklers to apply equal amounts of water.

*Frost Protection* The principle of using ice formation to prevent temperatures from falling below freezing is well known to fruit growers. Sprinkler irrigation can be used to protect blueberries during late spring freezes (photos 156–157), but a knowledge of certain physical principles is important for determining when to irrigate. The temperature of the applied water is usually greater than the temperature of the plants, so it warms the flowers initially. As the air temperature drops during the night and the water freezes, heat released from the water can be used to protect blossoms or fruit. As each gallon of water freezes into ice, 1,172 BTUs of heat are released. As long as liquid water is continually applied to the plants, the temperature under the ice will not fall below 32°F. Blueberry flowers can tolerate temperatures several degrees below freezing. Once irrigation begins, it should not be shut off until the sun comes out in the morning or the ice begins to melt.

The ability of a flower to tolerate temperatures lower than 32°F depends on several factors. The first is stage of development; open flowers are more prone to injury than closed flowers. Other factors include the length of time that plants are exposed to cold temperatures, the concentration of sugars and salts in the cell sap, and variety differences.

Even if the exact temperature when blueberry flowers are injured were known, it would not significantly improve the ability to protect from frost injury because the flowers in a field are at different temperatures. Flowers under leaves may not be as cold as others, and those near the soil will be warmer than those higher on the plant. In fact, on a clear night, the temperature of a flower can be lower than that of the surrounding air. Radiant cooling allows heat to be lost from leaves and flowers faster than it accumulates through conduction from the surrounding air.

Soil also retains heat during the day and releases heat at night. It is possible that on a calm, cloudy night, the air temperature can be below freezing yet the flowers can be kept warm by the soil. Wet soil has better heat-



retaining properties than dry soil, and mulch prevents the soil from warming or releasing significant amounts of heat.

It is difficult to control frosts on windy nights. Mixing of air occurs at the boundary of the flower, and air and plant temperatures tend to equilibrate. The disadvantage of wind at below-freezing temperatures is not only that heat is removed from the plant and soil, but heat is also removed through evaporative cooling which occurs when water is applied to the plants. Evaporation is a function of wind velocity and relative humidity. Less evaporation (and cooling) will occur on a still, humid night. For every gallon of water that evaporates, 7,760 BTUs are lost. The consequence is a reduction in heat contained in the plant.

Weather forecasts should be monitored daily during flowering. Sprinkler irrigation should be ready to turn on if a hard frost is forecast. The evening dew point gives an indication of how cold the temperature might fall on a clear, calm night. Irrigation should be turned on just before freezing occurs.

More water may be required for frost protection than for normal irrigation because enough water has to be applied to provide the needed heat exchange. It must be applied continuously over the entire protected area as long as the freezing temperatures last. The amount of water required increases at lower temperatures, under windy conditions, and for taller growing bushes, and can vary from 0.1 to 0.9 inch per hour.

Frost protection by irrigation is most successful during radiation frosts (cold, calm, clear nights) and, for practical reasons, at temperatures no lower than 20°F. At lower temperatures and in windy conditions, the water requirement is so high that most soils will become quickly saturated and ice buildup will occur that could ruin the crop and break the canes. An application requirement of 0.10 to 0.15 inch per hour is the usual design limit for sizing the water supply for frost protection, resulting in a water supply of 45 to 68 gpm per acre. Storage ponds must be sized to provide an adequate water supply for the entire frost, which can last several consecutive nights in some locations.

### ***Economics and Purchasing***

To determine the cost of an irrigation system, contact a reliable irrigation equipment dealer. Such dealers can design a system based on the crops grown, grower preferences, and site factors. A risk analysis should be performed once the cost of the irrigation system has been determined. The irrigation benefit, labor costs, initial costs, and operational costs should be compared to select the most appropriate irrigation system and to determine whether a reasonable return on the investment can be earned.

## ***Scheduling Irrigation***

---

Once an irrigation system is acquired, the major operational decisions are when to irrigate, how much water to apply, and how to use and maintain the equipment. Peak water requirements are estimated during the irrigation design process to make sure that the water supply and the irrigation system meet the highest demand.

Crop rooting depth, canopy development, fruiting habits, and nutrition and water requirements in a given climate largely determine the irrigation schedule. Soil infiltration and water-holding characteristics determine the rate of water application and the soil's ability to make water available to plants. Actual water use will vary daily throughout the season, so growers must develop a method to make sure the crop has an appropriate amount of water available.

### **Timing Irrigation**

Several methods are used to determine whether or not to irrigate, some more reliable than others. When plants show visible signs of water deficit, such as wilting, plant growth has already been stressed. Irrigation at this point may save the crop, but production has already been limited.

#### ***"Feel" Method***

In this method, the soil's appearance after being squeezed by hand is used to estimate water content. After much experience, this method may be quite reliable, and charts are available to describe how different soils should look and feel at different moisture contents. However, a common mistake is to feel the surface soil layers rather than soil around the root tips where most moisture is taken up. Avoid this problem by using a soil probe to sample soil in the crop root zone.

#### ***"Checkbook" or Water Budget Method***

The "checkbook" or water budget method is an accounting process of daily water use and rainfall inputs. Plant water use is estimated daily, based on crop development and climate conditions, and is compared to the soil's water-holding capacity. Irrigation should begin when the stored soil moisture approaches 50% of the available capacity, when plants become stressed. Moisture content should be measured periodically to verify water use and moisture depletion estimates. With experience, the water budget method can be quite reliable and is useful in predicting when irrigation should begin. Computer software programs using this budget method are available and can be adapted to particular site conditions. They also can be used to automate irrigation practices.

#### ***Other Methods***

Another method for irrigating most crops in the North is to assume that 1 to 1.5 inches of water are required weekly (the pan evaporation amount). The irrigation schedule can account for average weekly precipitation and plan irrigation to apply the difference. However, rainfall is still unpredictable, so this method can lead to deficits or excesses which may hold back crop performance. For blueberry crops, growers may wish to raise the water demand to 2 inches per week during fruit development, especially on well-drained soils.

For drip irrigation systems, a rule of thumb for young blueberry plantings is to apply 20 gallons per day per 100 feet of row. For mature plantings, the rate is increased to 35 gallons.

### **Tools for Scheduling Irrigation**

Many instruments have been developed to help growers schedule irrigations. Evaporation pans, atmometers, infrared thermometers, pressure bombs, and porometers monitor evaporative demand, plant stress or leaf moisture status. Tensiometers, gypsum or ceramic electrical resistance blocks, conductivity probes, matric potential (heat-dissipating) sensors, neutron probes, and time domain reflectometry (TDR) probes are used to monitor soil moisture.

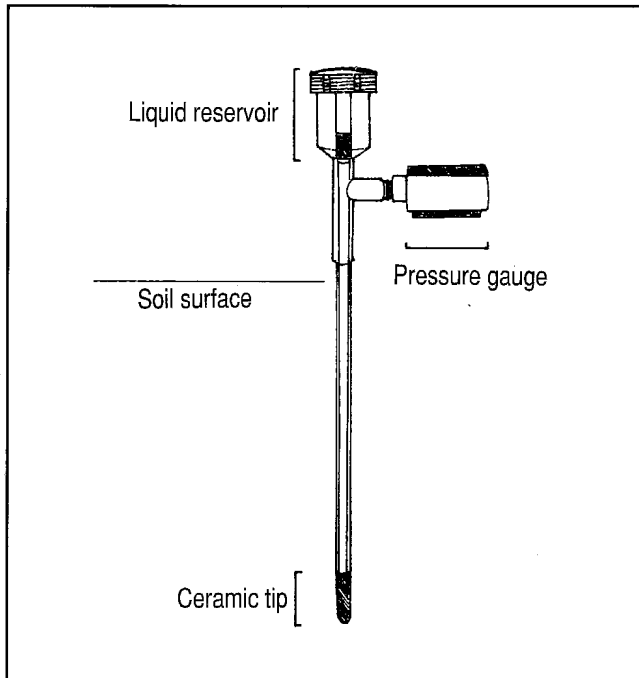
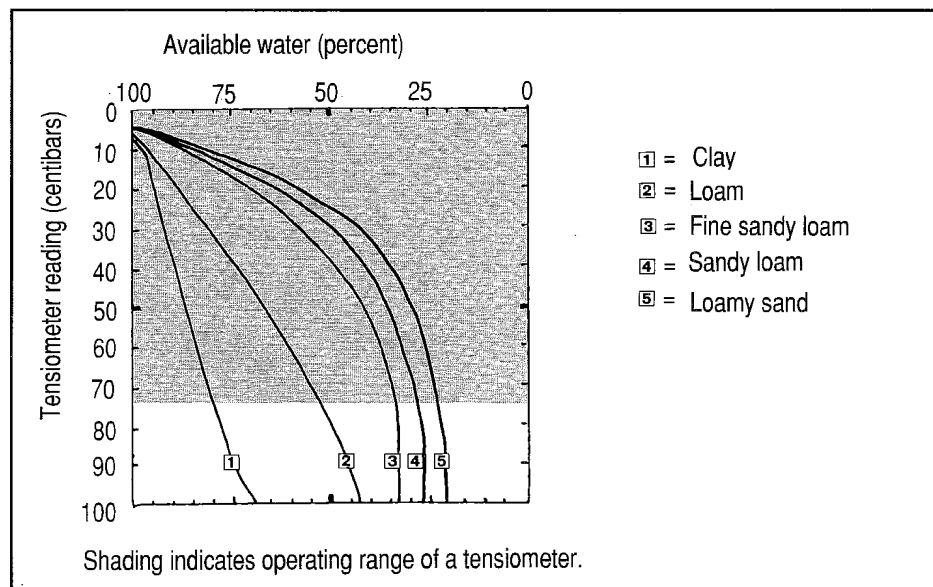

**Figure 11.** Tensiometer.

Some of these tools, such as the evaporation pan, atmometers, tensiometers, and gypsum blocks, are relatively inexpensive and easy to use. Others are more expensive and are used mainly for research. All of these tools require constant monitoring, maintenance, and calibration to be reliable for scheduling irrigation.

A tensiometer is a simple, inexpensive tool for measuring soil moisture status (figure 11). The ceramic tip of the tensiometer should be placed in the rooting zone of the blueberry plant, approximately 8 inches deep. When the reading reaches a critical level, irrigation is required. This critical level depends on soil type (figure 12). Soil moisture should not be depleted below 50% of its capacity; irrigation should be initiated when the tensiometer reading reaches this level. Tensiometers work well in the sandier soils but may require more service. The ceramic resistance blocks are also inexpensive and simple to use and provide a wider range of tension measurement.

Some instruments have been developed for automated monitoring of water requirements and, when integrated with the appropriate irrigation system, can automate the entire irrigation process. More information regarding these tools or scheduling methods mentioned above is available from your Cooperative Extension System or irrigation equipment dealer.



**Figure 12.** Relationship between soil type, saturation, and tensiometer reading.

## ***Equipment Use and Maintenance***

---

The appropriate use and maintenance of irrigation equipment, both in season and during storage, will increase its life and reduce operating and maintenance costs. An irrigation equipment dealer should provide an owner's manual and guidelines for operating and caring for the equipment.

The pumping unit and control head will require the most maintenance in terms of lubrication, cleaning, and protection from dirt, moisture, freezing, and animals. Leaking pump seals and pipe gaskets should be replaced as necessary. Sprinkler nozzles which have worn more than  $\frac{1}{16}$  inch larger than specified or emitters which are clogged should be replaced. Mains and laterals, particularly in drip systems, should be flushed periodically to remove buildup of precipitates and sediment. Equipment used in freezing weather must be properly lubricated and should be self-draining. The careful use and continued maintenance of irrigation equipment should assure many years of trouble-free performance and the satisfaction of producing a bountiful blueberry harvest year after year.

## ***For More Information***

---

Ross, D. S., R. A. Parsons, and H. E. Carpenter. *Trickle Irrigation in the Eastern United States*. Ithaca, New York: Northeast Regional Agricultural Engineering Service, 1985.

Available from NRAES, 152 Riley-Robb Hall, Cooperative Extension, Ithaca, NY 14853. (607) 255-7654.

## Chapter 13

# SPRAY APPLICATION TECHNOLOGY

Applying nutrients and crop protectants is an important part of blueberry production. During the last several years, there have been many changes in spray technology. New materials, management techniques, and application equipment have been developed. Some changes were the result of technical development; others were responses to new technology in pest control. Active research now in progress will introduce more changes in the future.

The basic purpose of a sprayer is to deliver a nutrient solution or a pesticide to targets such as crops, weeds, or soil. The sprayer must have a tank to carry the spray mix, which is the required chemical plus the water in which it is carried. The sprayer must maintain a uniform spray mix using an agitator, and control the flow of liquid with a pump and valves. The liquid is atomized into droplets by nozzles and carried to the target by an air stream and/or pressure.

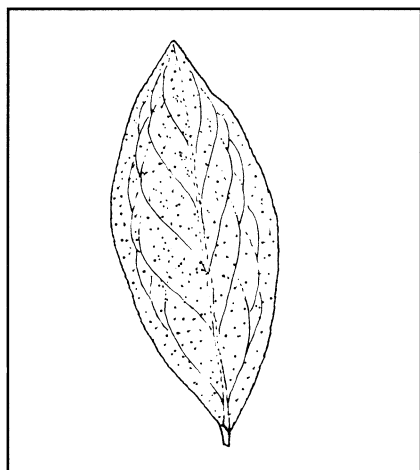

Coverage is the degree of spray treatment applied to all desired target surfaces (figure 13). For spraying blueberries, coverage includes treatment on soil, leaves, branches, and fruit. Good pest control requires uniform coverage, which is difficult because blueberry plants and rows may be of different sizes, densities, and shapes. Even if uniform plants could be developed, different parts of the plants are different distances and directions from the sprayer discharge. Often, a grower must overspray parts of the target to get adequate coverage (and control) on parts with minimal coverage. In general, 100 to 150 gallons of water are required to provide thorough coverage for an acre of mature blueberries. Growers must be careful, however, to avoid drift and overapplication for both economical and environmental reasons.

**Figure 13.** Uniform spray coverage on a blueberry leaf.

## Power Spraying Equipment

A variety of sprayer types are available (photos 158–161). A grower's "best" choice will depend on plant shape, size, and density; tractor size and power; and acreage to be sprayed. Equipment for spraying blueberry plants is very different from that used to spray for weed control. This discussion will focus on air-blast sprayers.

**Equipment Components** Blueberry sprayers used today are usually air-blast sprayers, except those used by very small commercial growers, homeowners, and hobbyists. Commercial growers normally use either powered or manual hydraulic sprayers.

Air-blast sprayers are either tractor-mounted or trailer units (figure 14). Tractor-mounted units are carried on the three-point hitch and are relatively compact and easy to maneuver. However, this arrangement transfers more

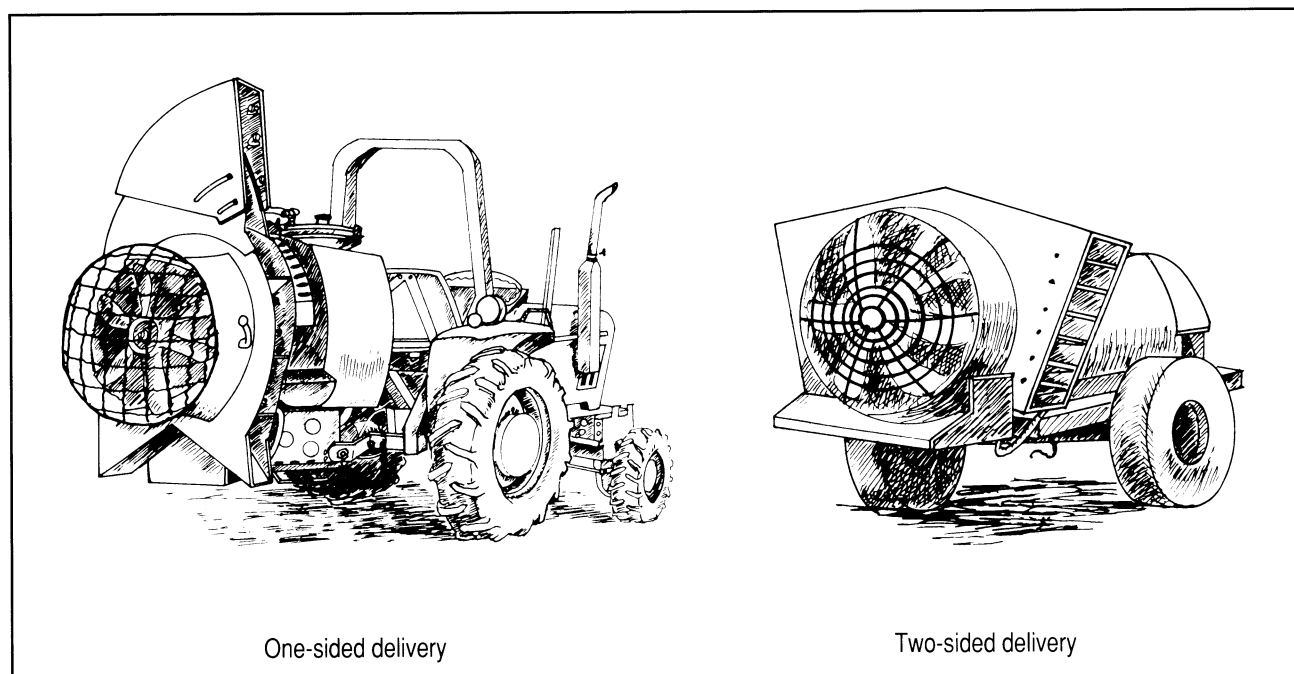

**Figure 14.** Tractor- and trailer-mounted air-blast sprayers.

weight from the front to the rear tractor tires. Ballast weights may be needed on the front end of the tractor to maintain stability and steering control, especially on hilly terrain. Mounted sprayers are powered from the tractor through the power take-off (PTO) shaft.

Trailer sprayers are heavier than tractor-mounted units. They have larger tanks and air capacities and may have a separate engine to power the pump, agitator, and fan. However, trailer sprayers, especially the smaller ones that can be used for spraying blueberries, often are powered by the tractor PTO.

**Sprayer Tanks** Tank size may range from 50 to 500 gallons. A tank should be made from a material that does not react with the chemicals it contains. It must be corrosion resistant and easy to clean. Tanks are typically made of fiberglass, plastic, or stainless steel, or of steel with a durable protective coating.

A tank should have a large hatch opening for easy inspecting and filling. The hatch should have a cover to prevent spray mix from splashing out of the tank. However, the hatch must let air into the tank as the liquid is removed to prevent the tank from collapsing. A tank drain makes washing, rinsing, and draining much easier.

**Sprayer Agitators** Agitation is very important to keep the spray mix uniform and to keep wetttable powders in uniform suspension. The sprayer tank should have an agitator—either a jet or mechanical type. A jet agitator uses part of the pump output to produce a jet stream in the bottom of the tank which provides a mixing action. Jet agitators are used on sprayers with centrifugal pumps, as their high flow rates support the jet. Mechanical agitators are used with piston or diaphragm pumps. Mechanical agitators are simply paddle wheels or propellers in the tank that mix the chemicals and water.

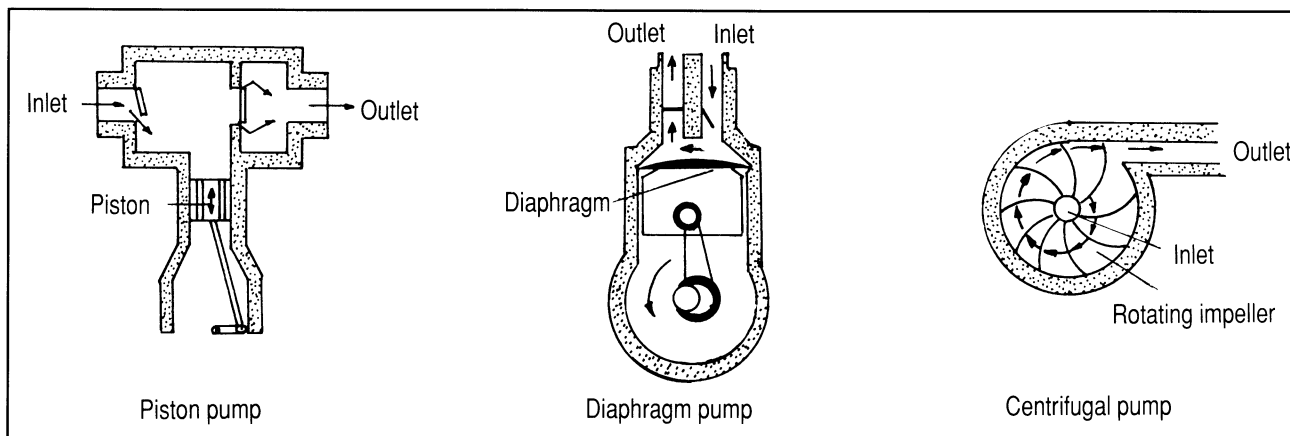

**Figure 15.** Pumps used on air-blast sprayers.

**Sprayer Pumps** Piston, diaphragm, and centrifugal pumps are all used on air-blast sprayers (figure 15). Piston and diaphragm pumps are positive displacement pumps; therefore, they are self-priming and can produce high pressures. Flow rate is directly proportional to operating speed. Centrifugal pumps are nonpositive displacement pumps; they are not self-priming and have a maximum working pressure of 200 pounds per square inch (psi) for multistage units.

Pumps should be selected to provide the required flow rate for the sprayer nozzles and jet agitator plus 20 to 25% extra capacity at the desired operating pressure. The extra capacity will provide a reserve to compensate for wear and other factors that may reduce flow over time. Power requirements of the pump are relatively low compared to those of the fan, but still need to be considered (table 16).

**Sprayer Nozzles** Nozzles are a very important part of any sprayer. Most nozzles have three functions: flow control, atomization, and droplet distribution. Some nozzles do not have a built-in flow control capability, so another type of flow control is built into the system. The nozzles on sprayers for blueberries are usually either hydraulic or air-shear types (figure 16).

**Table 16.** Characteristics of different pump types.

PUMP CHARACTERISTICS	PUMP TYPE		
	Centrifugal	Piston	Diaphragm
Materials Handled	Any spray solution	Any spray solution	Most spray solutions; some chemicals may damage diaphragm
Durability	Long life	Long life	Long life
Pressure Ranges (psi)	0–75 (Single stage) 0–200 (Multistage)	Up to 1,000	Up to 700
Flow Rates (gpm)	0–120	2–60	1–60
Operating Speeds (rpm)	2,000–4,000	600–1,800	200–1,200

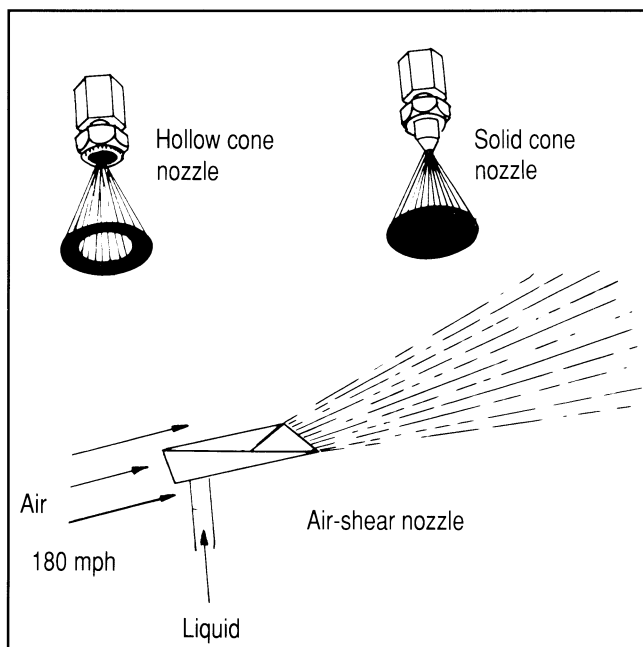

**Figure 16.** Sprayer nozzles.

Hydraulic nozzles regulate spray flow by the size of the orifice (opening) and the pressure at the nozzle. Hydraulic nozzles atomize liquid spray mix by using pressure to force the liquid through the orifice. With enough speed and energy, the liquid breaks up into droplets when discharged against the atmospheric pressure. High pressures and small orifices form small droplets, while low pressures and large orifices form large droplets. Droplet size is very important for coverage and drift control.

Droplets are discharged from the nozzle tip in some specific pattern, depending on the design of the nozzle. With air-blast sprayers, the droplets are injected into an air stream and carried to the target. With a handgun or boom sprayer, the speed built up at discharge must carry the spray droplets to the target.

Air-shear nozzles use a high-speed air stream to break up the liquid into droplets, so this nozzle is limited to sprayers with a high-velocity air discharge. Depending on nozzle configuration and injection angle, air speeds of 170 to 400 miles per hour are required. Discharging the spray directly into the air stream against the air flow produces the smallest droplets; at 90° to the air stream, intermediate droplets; and with the airflow, the largest droplets. Air-shear nozzles operate at low pressures, often in the 15 to 35 psi range. This results in slow wear rates for both the nozzles and the pump. Also, air-shear nozzles have large openings which minimize plugging.

As a nozzle wears, its performance deteriorates. The orifice enlarges, which increases the flow rate. As a result, atomization may change, producing different sized droplets as well as a different distribution of sizes. Wear also will cause droplet distribution patterns to become distorted.

For long-lasting nozzles, growers should select those made of materials that resist wear and corrosion. Sprayer tips may be made from brass, nylon, plastic, stainless steel, hardened stainless steel, tungsten carbide, or ceramic materials. Brass tips are the least expensive, but the metal is soft and the tips wear rapidly, especially with abrasive sprays such as wettable powders. Nylon tips cost about the same as brass, but wear better. Plastic tips wear inconsistently; they generally last longer than nylon but not as long as stainless steel. Stainless steel and hardened stainless steel tips cost more but wear much better—in the long run they can be bargains. Stainless steel tips resist abrasion and corrosion and are recommended for applying wettable powders. Tungsten carbide and ceramics last very long but may not be available for all agricultural sprayers.

Nozzle size, or actually the flow rate at the operating pressure, is very important. Nozzle sizes should be selected in relation to the travel speed of the sprayer so that the desired application rate is delivered. Enough liquid spray must be applied to provide coverage on all parts of the canes. On an air-blast sprayer, all nozzles may not be of the same size. Growers should follow the



manufacturer's recommendations for distribution of nozzle sizes within the manifold. Typically, the total application rate is about 100 gallons per acre on mature blueberry plants; lower application rates are adequate on immature plants. The total required flow through all the nozzles can be calculated with the following equation:

$$\text{FLOW (gal/min)} = \frac{\text{SPEED (mph)} \times \text{SWATH WIDTH (ft)} \times \text{DESIRED RATE (gal/A)}}{495}$$

If a grower wants to apply 100 gallons per acre and drive 2 miles per hour with a two-side delivery sprayer in rows spaced 10 feet apart, the required total flow through the nozzles is:

$$2 \text{ mph} \times 10 \text{ ft} \times 100 \text{ gal/A} \div 495 = 4.04 \text{ gal/min}$$

Swath width is the area effectively covered by the sprayer in one pass. Swath width equals the row spacing when two "half rows" are sprayed. The grower in the above example should select a set of nozzles that delivers close to 4 gallons per minute and run a calibration test. Driving speed or pressure can be adjusted to achieve the exact desired application rate.

**Sprayer Fans** Relatively large fans are required to produce the air stream used by air-blast sprayers to carry droplets to their target. The power required by a fan can be quite large, depending on its size and speed. Usually, either axial-flow or centrifugal fans are used.

The axial-flow fan (figure 17) has blades with airfoil cross sections, similar to airplane wings with a blunt leading edge and a thin trailing edge, attached to a hub. On some designs, the pitch (angle of attack) of the blades is adjustable to change the air flow or to match air flow to available input power. Typically, the fan is mounted inside a cylinder-shaped shroud for added efficiency. Air is drawn into the fan and accelerated along the axis of the fan, thus the name "axial-flow." Downstream from the fan, a deflector directs the air to the discharge where the spray mix is atomized and injected into the air stream.

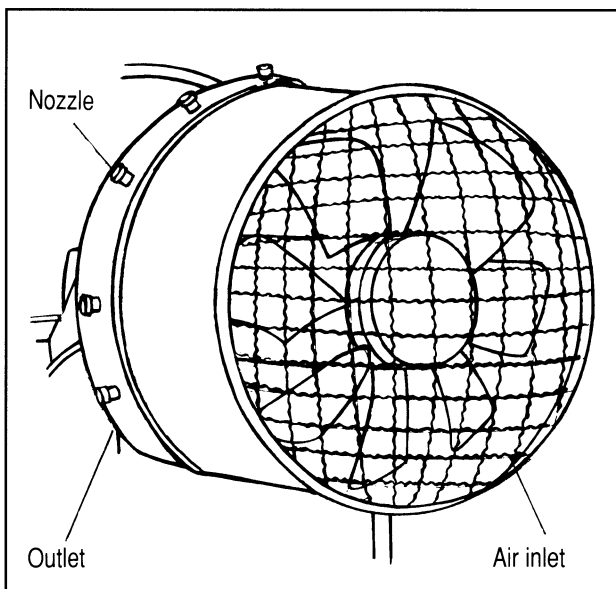

**Figure 17.** Axial-flow fan.

A centrifugal fan consists of a rotor or cage rotating in a surrounding housing. The rotor has radial blades that may be curved forward to scoop the air at relatively slow rotational speeds, straight, or curved backward to provide a smoother air flow. Because the forward-curved blade produces the highest air velocity at the same fan speed, it is the usual choice for sprayers. Air enters the end of the rotor and is forced outward at 90° to the input by centrifugal force produced by the rotating cage.

Fan performance is rated by the discharge characteristics of the air stream. Most sprayer manufacturers provide specifications on volume in cubic feet per minute and velocity in miles per hour. These

ratings are for standard operating conditions. For example, the standard operating condition for a PTO is 540 rpm. If the fan runs at a rate slower than standard, the air output will be reduced. If the fan is operated faster than the rated speed, the power requirement increases greatly. For example, a 10% increase in fan speed increases the power requirement by 33%.

### **Sprayer Calibration**

Calibrating a sprayer means making a “check” or trial run to determine the application rate. Sprayers should be calibrated before new nozzles are used for the first time and whenever pressure or speed is adjusted. Calibration requires only a few minutes and is time well spent. It is necessary to determine the actual application rate of the sprayer in the field because:

- 1) Chemicals must be applied at the proper rates to be effective and economical. A calibration test determines the application rate with the selected nozzles, pressure, and travel speed. Using more chemical than needed is wasteful and may violate the labeled rates; not using enough results in an ineffective operation and wasted expense for materials and labor.
- 2) Nozzle catalog values are based on pressure, travel speed, flow rate, and row or nozzle spacing. An inaccurate pressure gauge or speedometer, wheel slip, friction loss in the plumbing, or other factors may result in nozzle performance not matching catalog values.
- 3) A grower or operator must know the application rate so that the correct amount of chemical is added to the tank.

**Precalibration** The sprayer must be operating properly before calibration. The following precalibration checks are suggested:

- 1) Check and clean all nozzles and screens. Replace any that are damaged.
- 2) Observe nozzle patterns; they should be continuously smooth with no skips or heavy streams. Replace any nozzles that are suspect. If more than one or two need replacing, probably all need replacing.
- 3) Check the nozzles and their arrangement on the manifold. Follow manufacturer’s recommendations. Generally, nozzles in the bottom of the air stream have lower flow rates.
- 4) Check the pressure gauge. Pressure should be stable and at the desired level while spraying. If the gauge fluctuates due to pump pulsations, install a damper between the line and the gauge or use an oil-damped gauge. The gauge will be easier to read and will last longer.

**Calibration** Follow these steps for easy calibration:

- 1) Select a calibration plot between 0.1 to 1 acre. There are 43,560 square feet in an acre. If row spacing is 10 feet, then 4,356 feet of row represents 1 acre (43,560 square feet/10 feet). Therefore, 0.1 acre is approximately 436 feet of row. With a two-side delivery sprayer, two “half rows” (one row equivalent) are sprayed on each pass, but with a one-side delivery unit, only half of a row is sprayed, so the sprayer must travel twice as far to spray an acre.
- 2) During calibration, use only water in the spray tank. Results will be very close to actual spray conditions.
- 3) Make adjustments to obtain the desired pressure (while spraying) and travel speed.

- 4) Make a calibration test and determine the application rate. Two methods are suggested below:

#### **Tank Level Calibration Method**

After performing the precalibration check and steps 1–3 above, follow these steps:

- a) Fill the tank completely or to some known level with only water.
- b) Spray only the calibration plot selected and measured in step 1.
- c) Return to the filling site (exact location if possible) and accurately measure the amount of water required to refill the tank to the original level in (a) above. An alternative is to weigh the sprayer before and after the calibration test to determine the amount of water sprayed. Water weighs 8.34 pounds per gallon. CAUTION: Do not weigh the tractor since its weight will change with fuel consumption.
- d) Determine the application rate by dividing the amount of water used by the area sprayed. For example, if 24.5 gallons were applied to 0.25 acre, the application rate is  $24.5 \text{ gal} \div 0.25 \text{ acre} = 98 \text{ gallons/acre}$ .

#### **Time/Rate Calibration Method**

This method is similar to the above procedure, except that the sprayer is operated in place, without moving between filling and refilling.

- a) Determine the time needed to spray the plot selected and measured in step 1 by measuring the time required to drive over the calibration plot at the selected speed.
- b) Return to the filling site and fill the tank to some known level with water.
- c) Operate the sprayer, without moving, at the same pressure and pump speed for exactly the same amount of time measured in (a) above. It is not necessary to operate the fan.
- d) Accurately measure the amount of water needed to refill the tank to the previous level.
- e) Determine the application rate by dividing the amount of water used by the area sprayed. For example, if 30 gallons are required to refill the tank and 0.3 acre was sprayed (timed), the application rate is  $30 \text{ gal} \div 0.3 \text{ acre} = 100 \text{ gallons/acre}$ .
- 5) If the desired application rate is not obtained, adjust travel speed, adjust operating pressure or other flow rate control, or change nozzles. Rerun the test until the desired rate is achieved. Generally, only small changes are practical with pressure regulation. Larger changes are possible with speed control, but major changes usually require a different set of nozzles, except for air-shear nozzles where a separate flow control is used.
- 6) Once the desired application rate is obtained, record the number, sizes, and location of nozzles on the manifold; operating pressure or flow control setting; tractor speed or tachometer reading; and gear used. If the sprayer is later changed to a different rate but the grower wants to return to the original rate, this information will save time. Also, if an annual check is run at the same conditions and the results are recorded, growers will be able to monitor nozzle wear over several years.

**Sprayer Operation** Factors important in sprayer operation include tractor selection and operation, drift control, pump pressure, fan speed, and driving speed. Operators should practice with only water in the tank until they are completely familiar with all controls and procedures.

**Tractor Selection** Tractor selection for operating a sprayer is very important to good spraying. The tractor must have enough power to operate the sprayer at the desired speed, even on the steepest slopes, with a full tank of spray mix. If the sprayer is powered through the tractor PTO, enough power must be available to operate the fan and pump at the rated speed and to transport the sprayer at the desired speed.

Growers should check the sprayer manufacturer's specifications for the smallest tractor needed. Make sure the tractor is heavy enough and properly ballasted to safely handle the sprayer's weight on the steepest terrain to be sprayed, especially if the sprayer is a tractor-mounted unit.

Another factor is travel speed. The tractor should have a gear to provide the desired speed. Older tractors and some smaller ones have only a few gears, so the step between gears is relatively large. Growers must remember that, with PTO-powered sprayers, the fuel throttle cannot be used to regulate ground speed, since the engine must be operated to provide 540 rpm at the PTO shaft. In this case, one gear may be too fast and the next one too slow, unless the tractor has a hydrostatic transmission which provides stepless speed control.

**Drift Control** Drift is defined as spray that reaches nontarget areas. In simple terms, drift is the portion of the spray that misses the target or moves away from the target (plant, soil, or pest) afterward. Obviously, when spraying blueberries, some of the spray mix will not be deposited on the plants. The drift may be liquid droplets, vapor, or both.

Droplet drift is related to droplet size. Large, heavy spray droplets not intercepted by the plants will fall quickly to the ground, while smaller, lighter droplets will stay suspended longer in the air. These small droplets will be carried farther in the air stream of an air-blast sprayer and in any wind that is present. Drift within the field is inefficient but generally safe. Drift out of the field must be controlled.

Vapor drift from evaporating (volatile) chemicals can continue after the spraying operation is finished. Small amounts of highly volatile pesticides can collect and remain undiluted when air is stable, injuring susceptible plants well outside the treated area.

To minimize spray drift, growers should take the following precautions: use low spraying pressure, if practical, and large orifice nozzles (high application rates) to reduce the number of small spray droplets; direct hydraulic nozzles so that the discharge is parallel to and in the same direction as the air stream to minimize additional break up of the droplets by air shear; and use low-volatility chemicals that reduce vapor drift.

Other methods to reduce drift include using antidrift additives and spraying when climatic conditions do not increase drift. Antidrift additives increase the surface tension of the spray at the nozzle orifice so that fewer fine droplets are

produced. Climatic conditions such as wind and humidity affect drift. Growers should spray only when the wind speed is less than 5 miles per hour—early morning or evening is often a good time—and when the relative humidity is high, which reduces water evaporation and prevents droplet size from getting smaller after leaving the sprayer. If at all possible, growers should use chemicals that require large droplets.

Finally, growers should always keep a record of each spray application, including the date, time, material, rate, location, and weather conditions. Growers should contact their state's regulatory agency for more information on pesticide record keeping.

**Pump Pressure** Nozzle pressure, and therefore pump pressure, influences the droplet size produced by hydraulic nozzles. Increased pressure may improve coverage by producing more droplets, but the smaller droplets produced increase the drift potential. With air-shear nozzles, the pump creates only the flow, not the atomization, so a fairly low pressure will generate a smooth flow through the flow regulators. A pump should always be operated within its designed pressure range and according to the manufacturer's recommendations.

**Fan Speed** As noted earlier, the operating speed of the fan is important. Rated air volume and velocity is obtained only at a specified fan speed. Overspeed requires more power and underspeed results in lower air capacity. Fans should be operated at standard speed. One exception might be when spraying immature plants—growers may want to reduce the air velocity, but not if air-shear nozzles are used.

**Driving Speed** Travel speed may also affect spray coverage. As ground speed increases, the effective swath width of an air-blast sprayer will decrease. Although blueberries are easy to spray because of the plant size and row spacing, small sprayers with low air capacities may have to travel slowly to provide complete coverage. One theory is that all the air within the plant canopy must be displaced by the sprayer air stream, while another theory states that enough air must enter the plant canopy to produce turbulence throughout the entire plant. With either theory, ground speed must be matched to sprayer capacity to ensure that individual plants are exposed to the air stream long enough to receive good coverage. Spraying each row from both sides—driving each aisle once for two-side delivery sprayers and twice for one-side delivery—helps to minimize the problem.

## ***Spraying Equipment for Small Plantings***

Although air-blast sprayers make blueberry spraying easy and fast, they are relatively expensive and must be used on considerable acreage to be economically justified. This acreage may include blueberries or other crops, such as brambles, tree fruits, or vegetables, but the fixed (ownership) costs must be spread over many acres, even for the smaller air blast units to be feasible. Growers with smaller plantings will need to explore alternative, less expensive spraying equipment.

**Hand-held Sprayers** Hydraulic hand-held sprayers are “handgun” sprayers that may be equipped with single or multiple nozzles (figure 18). The multiple nozzle guns are

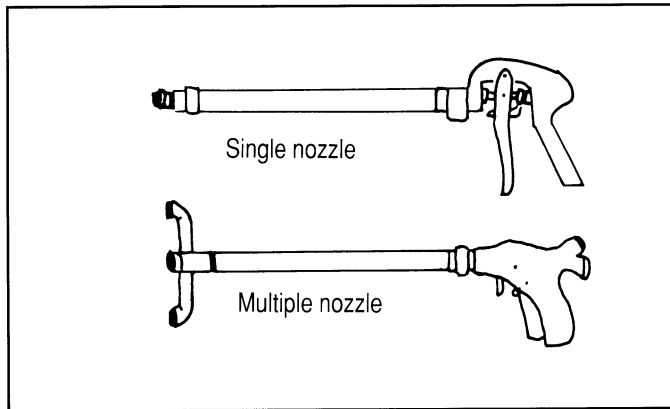

**Figure 18.** Hand-held sprayers.

actually miniature hand-held booms. Handguns are connected by a relatively long hose to a powered pump. Most handguns require high pressure, so either piston or diaphragm pumps are typically used.

The principle of handgun operation is that pressure is used to atomize the spray liquid into droplets, as with any hydraulic nozzle. The energy of the droplets' velocity at the nozzle discharge projects the spray to the target. The farther the target is from the handgun, the higher the pressure needed to provide enough velocity to carry droplets to the target.

Often, two people perform handgun spraying, one operating the handgun and one driving the tractor or other vehicle used to transport the sprayer through the field. This is convenient but increases labor needs. The quality of handgun spraying depends on the handgun operator. Much practice is needed to become skillful enough to obtain thorough coverage for adequate pest control without overspraying and to obtain uniformity in application rate. Working conditions such as temperature, fatigue, slope of terrain, walking surface, and length and weight of hose can increase the difficulty of handgun spraying.

### **Knapsack Sprayers**

Another sprayer suitable for small plantings up to about ¼ acre is the knapsack sprayer (figure 19). This sprayer is entirely manually operated and is carried on the operator's back by shoulder straps. Sprayer parts include the basic parts of most sprayers: a tank to hold the spray mix, a pump or pressurized gas canister to produce pressure and flow, controls to regulate flow, and an atomizer.



**Figure 19.** Knapsack sprayer.

Tanks are typically plastic or steel and in the 3- to 5-gallon size range. Some have a mechanical agitator that moves when the pump is used and provides some mixing; others may have jet agitation. Before spraying, however, the entire sprayer can be shaken to ensure good mixing.

Hand pump sprayers have a built-in piston or diaphragm pump. Some models can be adapted to either left- or right-handed pumping, with the free hand operating the flow control valve and the nozzle. The pumps are positive-displacement types and can produce relatively high pressures (80 to 180 psi). There is only a very small chamber where the liquid is under pressure, making the sprayer a "pump-as-you-go" system.

The distribution system includes an on/off valve, usually with a pistol-grip handle, and one or more nozzles. The nozzle is often mounted at an angle on a 16- to 20-inch wand to aid spray placement on the plants. Some designs provide for interchangeable nozzle tips so that nozzles can be better matched to the job.

Using a knapsack sprayer to spray blueberries is a time- and labor-intensive method. From the standpoint of equipment investment, the cost is low, but

the capacity is also very low. However, where labor is a minimal consideration, such as for many homeowners and hobbyists, the knapsack sprayer is effective if properly used. Since the operator controls the travel speed, variations in application rate similar to those caused by handgun systems can be expected. In addition, extra care should be given to coverage and uniformity because so little water is used as the spray mix carrier and diluent. It is not practical to apply any rate close to 100 gallons per acre with a hand sprayer.

### **Powered Knapsack Sprayer**

Another version of the knapsack sprayer has a very small engine and fan, creating a hand-carried air-blast sprayer (figure 20). This sprayer is also known as a motorized knapsack mist blower.

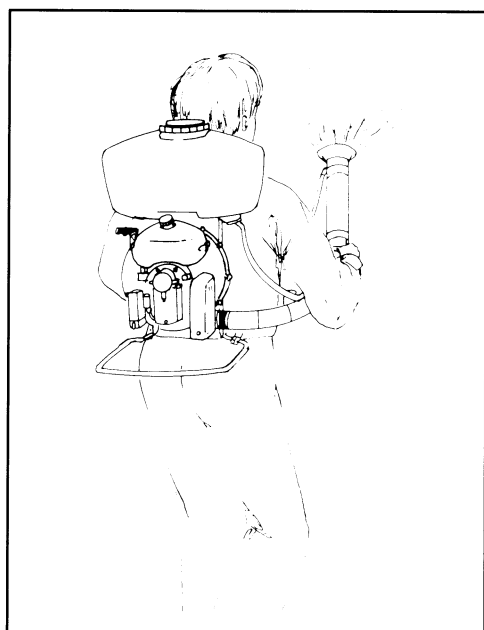

**Figure 20.** Powered knapsack sprayer.

Powered knapsack sprayers are equipped with 3- to 5-horsepower engines. Two-stroke cycle engines are used to minimize the weight; however, they require a gasoline/oil mixture for fuel. Operators should follow the manufacturer's recommendation on the oil-to-fuel ratio which may be given on the fuel tank or its cap. The engines operate at 5,800-8,000 rpm and are noisy—operators should wear ear protection. The sprayers are much heavier than manual models, weighing 17 to 25 pounds empty.

The engine operates a centrifugal fan which may deliver 200 to 450 cubic feet of air per minute. Discharge velocity is usually over 200 miles per hour. With this high velocity, air shear nozzles are practical and are often used. However, hydraulic orifice and rotary nozzles are also used to form and inject the droplets into the air stream. The air from the fan is fed through a flexible tube with an air nozzle on the end. The operator controls the direction of the air stream to place the spray material on the target. Because of the high discharge velocity, the air nozzle should be at least 6 feet away from plants. The air stream should be aimed downwind so that natural currents assist in dispersing droplets away from the operator. Spraying into even a slight wind may result in droplets being blown back onto the operator.

Motorized knapsack mist blowers can spray blueberries much faster than the manual sprayers. The air stream will assist in delivery and coverage, even at lower application rates. However, the area that can be sprayed is still limited because the sprayer tanks are about the same size or even smaller than those on manual sprayers, to limit the weight that operators must carry. Therefore, a tankful will cover only a relatively small area, and much time is required in refilling and measuring chemicals.

### **Hand Sprayer Calibration**

Hand sprayers need to be calibrated for the same reasons as power sprayers. The operator must first determine the percentage of an acre covered by one tankful of spray mix. By multiplying this percentage by the recommended application rate per acre, the operator easily calculates the amount of chemical required per tank. Before calibrating, the sprayer should be operated with only water to be sure all parts are properly working.

Handguns, manual knapsack sprayers, motorized knapsack sprayers, and other hand sprayers can be calibrated with the following method:

- 1) Select a calibration plot (row length) that represents  $\frac{1}{100}$  to  $\frac{1}{20}$  acre. A bigger plot will produce more accurate results. There are 43,560 square feet in an acre; therefore, row length per acre is 43,560 square feet per row spacing (feet). For example, if the blueberries are planted in rows 10 feet apart, there are 43,560 square feet  $\div$  10 feet = 4,356 feet of row per acre. There are approximately 44 feet (4,356  $\div$  100) of row in  $\frac{1}{100}$  of an acre, and 220 feet (4,356  $\div$  20) in  $\frac{1}{20}$  acre.
- 2) Fill the sprayer tank with only water and spray the calibration plot at a rate that achieves good plant coverage. This requires good judgment; an inexperienced operator should get help or training from an experienced or trained pesticide applicator. The goal is to provide coverage to the entire plant without reaching the point of runoff (spray mix dripping from plants), to avoid waste and potential pollution.
- 3) Measure the amount of water required to refill the sprayer tank to the previous level. Calculate the application rate by dividing the amount of water used by the area covered. For example, if  $1\frac{1}{2}$  quarts were applied to  $\frac{1}{100}$  of an acre, the application rate is 38 gallons per acre ( $1\frac{1}{2}$  quarts  $\div$  4 quarts/gallon  $\div$   $\frac{1}{100}$  acre).

A preferred alternate method for hydraulic handgun sprayers (not mist sprayers) is a modification of the above method.

- 1) Same as step 1 above.
- 2) Same as step 2 above but, in addition, determine the time required to spray the calibration plot as measured.
- 3) With the sprayer in place, spray into a container for the time measured in step 2. Be sure to collect all the water for the exact time period. The water in the container will be the same amount applied to the calibration plot. Calculate the application rate as described in step 3 above.

### **Hand Sprayer Operation**

Hand sprayers require much more labor to operate than the tractor-powered air blast units, so hand sprayers are limited to small plantings. High application rates similar to the powered air-blast sprayers are feasible with the powered handgun because the spray mix is carried by the tractor or a trailer and the pump is powered. However, with knapsack sprayers, it is not practical to use such high rates.

A major problem with hand sprayers is the inability of an operator to walk along a row at a uniform rate. Variation in walking speed will vary the application rate. However, an experienced applicator may be able to compensate for variations of plant density in the plant row. For example, if a plant is missing in a row, the operator can skip that space and move immediately to the next plant. Inexperienced operators should practice with water until they can apply a pesticide uniformly at the recommended rate.

Hand sprayers necessarily place the operator near the nozzles and discharge point of the sprayer. This makes operator protection very important. All operators should read the labels and follow directions for the specific material being applied. Basic protection includes a hat, long-sleeved shirt and trousers, or a spray suit. Depending on the toxicity of the chemicals, other protective gear such as a respirator, goggles, waterproof gloves, or waterproof



boots may be needed. The spray should be discharged with the wind so that droplets are carried away from the operator. If spray is directed into the wind, some will be blown back onto the operator.

Drift can be a problem with hand sprayers and may be even more important where lower application rates are used. The spray mix is more concentrated, so any loss means more active ingredient is lost. The best solution is to spray only when winds are calm or blowing at less than 5 mph—when there is very little air movement. Operators should use as low a pressure and as large an orifice as is practical to minimize the number of small droplets formed. A drift control additive placed in the spray mix may also be helpful.

## **Sprayer Maintenance**

---

Like all other equipment, sprayers must be kept in good working order to last a long time. Cleaning is especially important because of the chemicals used. A very thorough cleaning should be performed whenever chemicals are changed and at the end of each spraying season. Sprayers must be protected from corrosion and freezing in storage during the off season.

### **Cleaning**

Sprayers must be cleaned to prevent corrosion, cross contamination of pesticides, and crop injury. Trace amounts of one pesticide can react with another or carry over to the next spraying and cause damage. Long exposure to even small amounts of some pesticides can damage sprayer parts, even stainless steel tips and fiberglass tanks. If crops are sprayed that are sensitive to the herbicides used, maintain two sprayers—one for herbicides and one for all other spraying. No cleaning method is perfect, but careful cleaning will remove all but insignificant amounts of insecticides and fungicides.

Always try to end the day or a spraying job with an empty tank to avoid having leftover spray mix. Be careful when disposing of leftover mix or wash water; avoid contaminating water supplies and injuring plants or animals. Do not leave puddles that might be accessible to children, pets, farm animals, or wildlife. Two recommended methods of disposal are to collect the waste in a holding tank and recycle it during the next spraying or to spray waste on another area with similar plants and problems while being careful to avoid overapplication of pesticides.

When the sprayers are empty, triple rinse the tanks with clean water, preferably after each day's operation. Also, rinse the outside of the sprayer. Whenever pesticides are changed or before winter storage, clean sprayers thoroughly with a cleaning solution. Check the pesticide label for directions. Generally, a good detergent solution will remove most insecticides and fungicides. First, flush with water, then add the cleaning solution to the tank and thoroughly agitate it before flushing again. Always flush with clean water to remove the cleaning solution.

Remove nozzle tips and screens; clean them in a strong detergent solution or kerosene, using a soft brush such as an old toothbrush. Follow the same safety precautions during cleaning as for mixing and application. Use a respirator, waterproof gloves, or other protective gear as directed by pesticide label instructions.

**Lubrication** Lubrication may be required, depending on sprayer design. Some sprayers are built with sealed bearings that do not require additional lubrication. Wear points other than bearings may need to be greased or oiled. Some sprayer parts may need to be coated to prevent corrosion during nonuse periods. Check and follow the instructions in the owner's manual.

**Winterizing** Sprayers must be protected from corrosion and freezing during winter storage. If a sprayer has no rubber parts such as gaskets, diaphragms, hoses, etc., put new or used engine oil from a gasoline engine in the tank before the final flushing to prevent corrosion. As water is pumped from the sprayer, the oil will leave a protective coating inside the tank, pump, and plumbing. Remove nozzle tips and screens and store them in a can of light oil such as diesel fuel or kerosene to prevent corrosion. Close nozzle openings with duct tape to prevent dirt, insects, or mice from entering.

In all cases, protect the pump. If the pump has rubber parts, disconnect the lines and put automotive antifreeze or radiator rust inhibitor in the inlet and outlet ports. If the pump has no rubber parts, engine oil is satisfactory. Rotate or move the pump several times to completely coat interior surfaces.

During the final cleaning, completely check the sprayer. Inspect the hoses, clamps, connections, nozzle tips, and screens for needed replacements. Store the sprayer in a clean, dry building.

## Chapter 14

# HARVESTING AND HANDLING BLUEBERRIES

---

No area within the blueberry industry has undergone such dramatic changes as the harvesting and handling of blueberries. Increasing problems with the availability of the traditional labor force and the simultaneous desire to maintain or increase quality have been the impetus for the blueberry industry to adopt the latest mechanization technology.

## ***Preharvest Treatment***

---

A quality product is essential to maintaining a viable blueberry industry. Many factors affect the quality of harvested fruit.

***Varieties*** Shippers should avoid planting varieties that have quality problems. Dixi, for example, has a large wet stem scar which results in increased postharvest problems. Additionally, a PYO operation should avoid varieties such as Elliott which turn blue before developing sweetness. Variety selection should be governed by the grower's marketing strategy (see chapter 4).

***Pruning*** Proper pruning techniques result in earlier, more uniform, and larger berries that are easier to pick. Pruning often makes the difference between hand pickers who return to pick and those who leave the farm. Pruning enables the pickers to harvest more rapidly, thereby decreasing the likelihood of overripe fruit in the field and also decreasing the cost of harvest to the grower. Lastly, pruning is very important in the control of disease in the blueberry field (see chapter 6).

***Crop Protectants*** The use of labeled pesticides to control insects and diseases is often critical to obtain optimum quality; however, growers must adhere to the recommended postharvest interval for these chemicals. Judicious use of pesticides will lower the cost to the grower and satisfy customers who are concerned about chemical use.

***Fertilizer*** High levels of nitrogen fertilization have been associated with poorer keeping quality in many fruit crops. Overly vegetative plants result in slower ripening and poor quality in blueberries. The use of regular soil and leaf sampling will help the grower to customize fertilizer programs for field conditions (see chapter 11).

***Pollination*** Poor pollination can greatly reduce fruit quality. A decrease in fruit set may be due to cold, wet weather, competing weed flowers, or simply an inadequate number of bees in the field. Growers who at one time could rely on native bee populations may find their yields decreasing every year due to increasing urbanization in the area. Many varieties of blueberries have the ability to set berries without insect pollination; however, these berries will be much smaller, will ripen later and will be fewer in number (see chapters 2 and 6).

**Rain** After the grower has conscientiously provided the inputs necessary to achieve a quality product, nature will have the final word. Rain can adversely affect fruit quality if it comes at a critical time, such as bloom or harvest. Harvest may be delayed, fungicides may wash off, berries may soften, stem scars may become moist, berries may split, and disease organisms may increase in numbers. Berries that appear acceptable to the grower may quickly become unacceptable for the salesperson if they have been exposed to heavy rain for prolonged periods before harvest.

High temperatures combined with rain exacerbate the previous problems. Under these conditions, fruit should be harvested for the processing market.

## Harvest

To ensure the longest postharvest shelf life for both fresh and processed fruit, a detailed postharvest plan should be developed and posted so that all pickers, field supervisors, and packing shed personnel are aware of expectations. Be sure that copies are in appropriate languages for non-English-speaking workers.

Cultivated highbush blueberry plants generally reach full production within 6 to 10 years after planting; however, a partial crop may be harvested within 3 or 4 years. The harvest season of cultivated blueberries depends on a number of factors. The most important are the variety and the climate of a particular production area. The harvest season begins about May 10 in North Carolina, June 10 in New Jersey, July 5 in Oregon and Washington, and July 10 in Michigan (table 17).

**Table 17.** Typical blueberry harvest dates.

STATE/PROVINCE	HARVESTING BEGINS	HARVESTING PEAKS	HARVESTING ENDS
Florida	4/15	5/1–6/10	6/15
North Carolina	5/10	5/25–7/1	7/10
Arkansas	6/1	6/10–7/15	7/25
Georgia	6/1	6/8–7/10	7/18
New Jersey	6/10	7/1–8/15	8/30
Oregon	7/5	8/5–9/5	9/10
Pennsylvania, Massachusetts, Connecticut	7/5	7/20–9/5	9/25
Washington	7/5	8/5–9/5	10/5
Michigan, New York	7/10	7/25–9/10	10/5
British Columbia	7/15	8/1–8/25	9/10
Maine, Vermont	8/1	8/10–8/25	9/5
New Brunswick	8/10	8/15–8/25	9/10
Quebec	8/10	8/20–9/5	9/15
Nova Scotia, Prince Edward Island	8/15	8/20–8/30	9/10
Newfoundland	9/5	9/10–9/20	9/25

Yields on a typical blueberry site will run from the second to the sixth year, respectively, 50, 200, 2,000, 4,000, and 6,000 pints per acre (40 to 4,500 pounds per acre). A mature plant will bear an average of 6 to 8 pints (4.5 to 6 pounds), but with proper soil management and pruning, it may produce 20 pints or more per year. Variations in yield are due largely to winter damage to buds and canes as a result of extreme winter temperatures and to spring frosts during bloom.

Cultivated highbush blueberries do not ripen simultaneously throughout the cluster. Jersey has more mature fruit in the middle of the cluster at first, but later in the season, ripe berries are more evenly distributed. Berries continue to enlarge for some time after they appear ripe (blue). Harvesting too early results in a reduced yield. Allowing berries to become more fully ripe (3 to 5 days after turning blue) improves flavor and increases size. Although unripe berries will turn blue after harvesting, they are smaller and have a lower sugar content than berries allowed to ripen completely on the bush. The size of blueberries at harvest seems to be governed mainly by moisture conditions if nutrition and pollination are adequate.

Cultivated blueberries must be picked several times during the harvest period. The harvest interval, usually 7 to 10 days, has the greatest effect on berry quality. If temperatures have been above average, quality is not likely to be acceptable after 7 days. As the picking season progresses, the harvest interval should decrease. The fruit in late-maturing varieties tends to require fewer pickings.

### **Mechanical Harvesting**

The practice of machine harvesting fruit is increasing. Three types of machines are in use. One type is a hand-held vibrator with a catching frame that is powered by electricity (photo 162). The second is pulled by a tractor and shakes the fruit off (photo 163). The third is a self-propelled over-the-row machine that also shakes the fruit off (photo 164). Fruit harvested by machine usually must be cleaned and sorted before it can be sold. Most machine-harvested fruit is processed, not marketed fresh.

Most growers prefer hand harvest for the first two pickings since the mechanical unit tends to remove green berries that can ripen into marketable fruit. The mechanical picker is much more efficient for later harvests.

Over-the-row, self-propelled machines with collecting pans and conveyer belts are capable of picking  $\frac{1}{2}$  acre per hour, thus replacing about 160 hand pickers. Recent estimates put the cost of machine harvesting and sorting fruit for processed markets at 18 cents per pound. In comparison, the cost for hand-harvested fruit packed for the fresh market amounts to 41 cents per pound, including packing supplies and labor costs.

The increase in mechanical harvesting of blueberries is largely due to the rapid expansion of blueberry acreage and production, the loss of a reliable work force for hand harvesting, and the development of a market for processed highbush blueberry fruit. Not all fields can be mechanically harvested, however. Self-propelled harvesters require 10 feet between rows and 25-foot headlands for turning. Ground slopes greater than 10% are difficult to harvest. Plants must be pruned annually to keep crowns narrow.

Mechanical harvesters detach berries by vibrating the bush. The vibration principle of harvesting is generally successful because green berries are attached to the bush more securely than ripe berries. Careful machine adjustment makes possible the removal of a high percentage of the ripe fruit, while most of the green fruit remains on the bush to ripen for a later harvest.

Many harvesters use a slapper-type mechanism to dislodge the fruit, but this method can cause considerable bush damage and berry loss. Sway-type picking mechanisms also exist that reduce bush damage, but these can excessively compress bushes during harvest. The most recent harvester technology uses a rotary head principle. On either side of the picking tunnel, a revolving drum with multiple nylon wands turns with the forward motion of the harvester. Drums travel vertically to shake the fruit off the bushes where it falls onto a fishplate conveyor.

Once fruit is mechanically harvested, it must be sorted. Lugs are emptied onto a belt that passes through a blower system to remove stems and leaves. The fruit then travels through a water dump tank where underripe fruit is separated and used for juice. The conveyor belt next passes through another blower which dries the fruit before hand sorting. If the fruit is destined for bulk freezing, it goes directly into a shipping container. Standard containers are 6½- or 30-pound plastic pails, or 400-pound metal drums lined with plastic. Block frozen berries are packed either without sugar, or with a 4 to 1 ratio of berries to sugar.

Machines do harvest overripe, shriveled, soft, diseased, insect- and bird-damaged, green, or other fruit that a good picker would not. Thus, much more handling of this fruit is necessary in comparison to hand-harvested fruit. Bruising occurs each time a berry is dropped, squeezed, or rubbed; severe bruising reduces the keeping quality of the fruit. The following measures will reduce bruising:

- Harvest during cool periods of the day.
- Avoid excessive bush impacts and vibration by adjusting machine vibration to the minimum level required to remove ripe fruit.
- Minimize distance of drop from harvester to field containers.
- Do not fill field containers to a depth of more than 5 inches and do not level the berries in the containers with the hands.
- Use softly suspended trailers or trucks to reduce bruising on the way to the packing house and make access roads as smooth as possible.
- Handle and dump field containers gently.
- Limit fruit depth to 2 inches at any point along the route.
- Adjust the air volume of the forced-air cleaner to avoid lifting and dropping ripe fruit more than 1 inch.
- Do not allow individuals operating the inspection belt to rub or squeeze the fruit.
- Minimize the drop from the inspection belt to the shipping container.

Mechanical harvesting can result in fruit loss of between 15 and 50% when compared to hand picking. Fruit loss is in the form of ripe and green berries dropped, green berries picked, and soft berries that must be discarded. Mechanical harvesting can damage the blueberry bush by removing the bark down to the xylem conducting tissue; the lesion that forms is associated with winter injury. The severity of this injury can be lessened by decreasing the amplitude of the machine's vibrating bars.

**Hand Harvesting** The picking method chosen should result in as little handling of the berries as possible to minimize bruising and the spread of organisms that cause fruit decay. With hand harvesting, ripe berries should be rolled from the cluster into the palm of the hand with the thumb and not plucked off as is done with most fruit crops. This method prevents immature berries from becoming detached and also does less damage to the bloom or light blue color of the fruit. Berries should never be picked when wet.

Hand picking is often done mainly by migratory workers and locally hired pickers. The quality of berries harvested by a picker depends on both skill and the crop load on the bush. The average picker can harvest 5 to 6 twelve-pint flats (9 pounds per flat) per eight-hour day; however, highly skilled pickers working on well-loaded bushes can pick as much as 20 twelve-pint flats per day. Two to four pickers per acre are needed at the beginning and end of the season, eight to ten at the harvest peak. Pickers are usually paid based on the number of berries picked, which requires record-keeping to protect the employer and the pickers. In most areas, pickers are given numbered tickets that represent their assigned number. The picker places one ticket in each flat when it is brought to the collecting center in the field. The tickets are turned in daily or weekly, then counted and recorded. Progressive growers have begun to use bar code scanners to record pickers' names, pounds picked, and hours worked.

One method of harvesting involves picking directly into the market containers. This has the advantage of minimum handling and better preservation of the surface bloom. The picker may carry the market box, usually a pressed-paper pint container, inside a small container that can be strapped to the waist. This method also enables a picker to use both hands. Filled pints are placed into a field box which holds 12 pints. These field boxes may be taken to the central pickup area by the picker, or they may be picked up by workers assigned to this task, allowing the pickers to continue working. Field boxes are then loaded onto trucks containing pallets for easy unloading at the packing shed.

Pickers should be instructed not to overfill flats; compression results in poor cooling and bruising. Harvested berries should not be allowed to sit in the sun. If no shade is available, a light-colored tarpaulin should be placed over the flats and wetted periodically. Flats should be loaded and transported carefully, and all handling equipment should have functional suspension systems.

For fresh operations where fruit is picked into buckets, a sorting belt will need to be installed so that underripe, overripe, and rotten fruit, as well as twigs and leaves, can be removed (photo 165). Provide for the comfort of

workers in the sorting line by having available stools or platforms, good lighting, and temperature control. Sorters should clip fingernails, remove rings, and wear hairnets. Berries should be only one layer deep when flowing along the belt. At the end of the sorting line, berries drop into standard pint containers. A standard shipping flat contains 12 pints (photo 166), and a standard pallet contains 96 flats. Fresh blueberries are not washed during the sorting process, but the line itself is washed daily with soap and water to remove accumulated dirt.

Large growers and cooperatives have recently been replacing manual packing lines with mechanical sorters and packers due to the scarcity of labor. An average worker can pack 200 crates of berries per day, whereas the machines pack 5 crates per minute. Thus, one machine can do a day's worth of manual work in just 40 minutes. The machine can pack as many as 300 flats per hour manned by just 7 workers.

Most methods of sorting blueberries involve separation by berry firmness, optical density, or mass density. One of the most technically demanding approaches is an optical-density sorting system which is run in conjunction with an instant quick freeze line (IQF). In this system, machine-harvested berries are immersed in a chlorination tank to control postharvest decay, then put onto a belt moving at 500 feet per minute. Here, the berries enter a high-speed sorting system: during this process, a video camera looks at each berry, distinguishing the bad from the good as they pass under a 4-foot by 18-inch screen. As the camera views the green or discolored berries, an electronic controller triggers the 128 computer-regulated air jets, which force inferior berries off the track into a discard bin. Good berries continue along a conveyor belt until they are dumped into a vat of liquid nitrogen kept at  $-320^{\circ}\text{F}$ . The quick bath freezes the berries so the fruit can be rolled more easily to detach the stems. Berries are then brought back up to about  $30^{\circ}\text{F}$  and poured into shipping boxes. IQF fruit is commonly packed into corrugated boxes lined with plastic bags. The industry standard is a 30-pound box.

Many fresh-market growers cover their pints with sheets of cellophane bearing the farm's name, held in place by a rubber band. The covering reduces water loss, keeps out dust, and improves appearance.

Recommendations have long been directing growers to refrigerate berries as quickly as possible after packing. Research has shown that berries kept at  $32^{\circ}\text{F}$  and 85% relative humidity will have a shelf life of 2 weeks, at  $40^{\circ}\text{F}$  a shelf life of 1 week, but at  $72^{\circ}\text{F}$  only 2 days. Most growers are aware of this information, but in reality, most berries are not cooled below  $60^{\circ}$  because berries tend to sweat if exposed to ambient air because of mishandling somewhere along the distribution line. Wet fruit and moisture on the cellophane wrapping of fruit containers are considered undesirable and suspect by buyers and marketers; fruit in this condition is often rejected even though the grower is not at fault. Thus, some growers place the palletized flats of berries in coolers kept at  $60^{\circ}\text{F}$  to remove the field heat. This is done as quickly as possible after harvest; no more than 1 hour should elapse between harvest and cooling. Berries at  $60^{\circ}\text{F}$  are then packed and shipped out. Small growers who are not using distribution systems should cool their berries to  $33^{\circ}\text{F}$ . It should be realized, however, that when flats so treated are placed in ambient



air, condensation may occur on them. Placing flats in plastic bags when entering the cooler or soon afterward will prevent problems: when the flats are removed from the cooler, condensation forms on the plastic, which is removed once the berries reach ambient temperatures. Berries cooled properly to 33°F should have a shelf life of 14 days.

Smaller, efficient operations combine a precooling setup with a refrigerated cold room.

## Transportation

Most fresh blueberries are shipped by refrigerated trucks. A diesel motor powers a refrigeration unit that sends cold air from the front of the trailer to the rear, where it is deflected down and back toward the front under the flats of berries. Flats should be loaded on wooden pallets and along a centerline

pattern to ensure good airflow (figure 21). The berries should be cool before loading the berries because the refrigeration unit is not capable of cooling a warm load of respiring fruit.

Fresh blueberries are also shipped by air to distant market locations. Insulated LD3 containers are commonly used; each has a cargo weight capacity of 3,100 pounds, with 125 pounds of dry ice to keep the temperature low during shipping. (Fruit seldom arrives below 40°F.) Growers either rent these containers from the airlines or purchase their own.

Smaller Series E containers are used for 482-pound shipments. When gel ice is added to the flats of berries and the box is sealed, fruit temperatures stay below 40°F during transit.

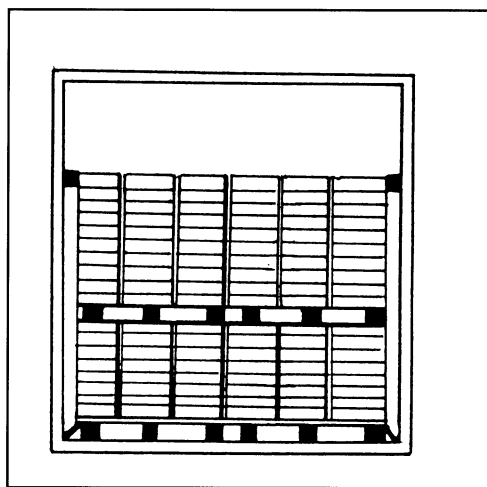

**Figure 21.** Proper loading of a refrigerated trailer.

## For More Information

Bartsch, J. A. *Walk-In Cooler Construction*. Extension Bulletin 453. Ithaca, New York: Department of Agricultural Engineering, Cornell University, 1986. Available from Cooperative Extension, 304 Riley-Robb Hall, Ithaca, NY 14853. (607) 255-2080.

Bartsch, J. A., and R. Kline. *Produce Handling for Direct Marketing*. NRAES-51. Ithaca, New York: Northeast Regional Agricultural Engineering Service, 1992. Available from NRAES, 152 Riley-Robb Hall, Cooperative Extension, Ithaca, NY 14853. (607) 255-7654.

Kader, A. A., Technical Editor. *Postharvest Technology of Horticultural Crops*. Special Publication 3311, Second Edition. Davis, California: Cooperative Extension Service, University of California, 1992. Available from ANR Publications, 6701 San Pablo Avenue, Oakland, CA 94608. (415) 642-2431.

## Chapter 15

# MARKETING BLUEBERRIES

Blueberry markets and production trends are changing rapidly. Acreage has steadily increased in nearly all traditional blueberry production regions, and blueberry plantings have been initiated in several nontraditional areas as well. Although no one can predict the future with certainty, it is clear that blueberry production in North America will continue to increase. Since blueberry plantings require 6 to 8 years to reach maturity and remain productive for many years, a planting is a very long term investment. Planting decisions must be based on what prices and markets are likely to be when new plantings come into production (see chapter 16).

A second trend seen recently is the change in traditional marketing windows. Fresh blueberries are available to consumers over an ever-lengthening period — the combined result of the development of new varieties, new growing areas, and improved technology for the storage, packaging, and handling of blueberries. These changes may influence the relative market advantages of growers in some regions. Planting decisions must be based on both local acreage trends and trends in regions with similar market windows.

Blueberry producers marketing fresh berries locally (PYO or picked) compete directly with other growers in the immediate area. However, producers outside the local area often compete either directly or indirectly with all other growers, since berries from major production states are shipped throughout most of the United States. In reality, growers compete most heavily with other commodities for the consumer's food dollar.

## Production and Price Trends

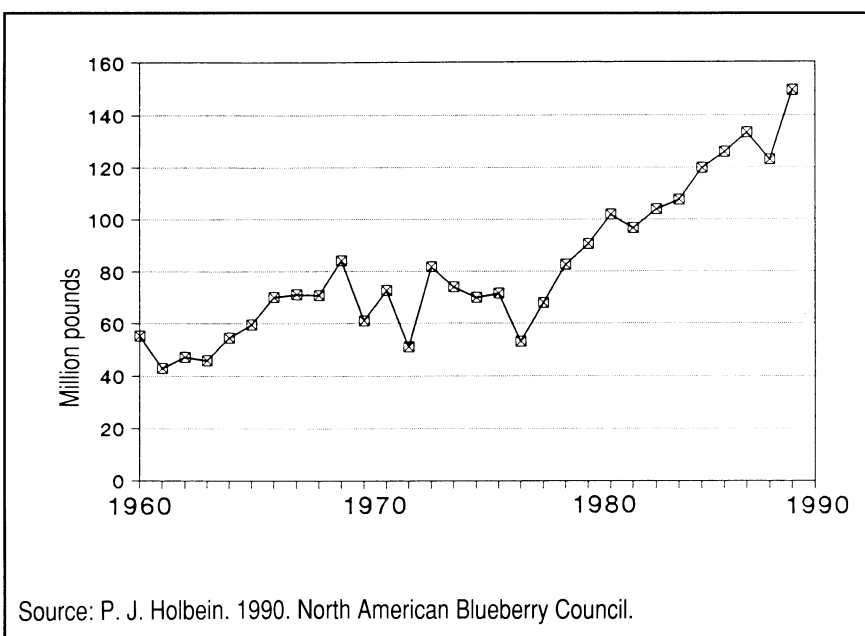

**Figure 22.** Trends in North American blueberry production.

Total North American blueberry production has expanded substantially in recent years (figure 22). Production has increased in all major producing states and Canadian provinces as well. Recent planting trends suggest that production will increase at similar or greater rates during the 1990s.

Increased production of blueberries has been encouraged by an upward trend in raw-product prices (figure 23, next page). However, growers are concerned about how long the upward trend in prices can continue in light of the dramatic increases in blueberry production.

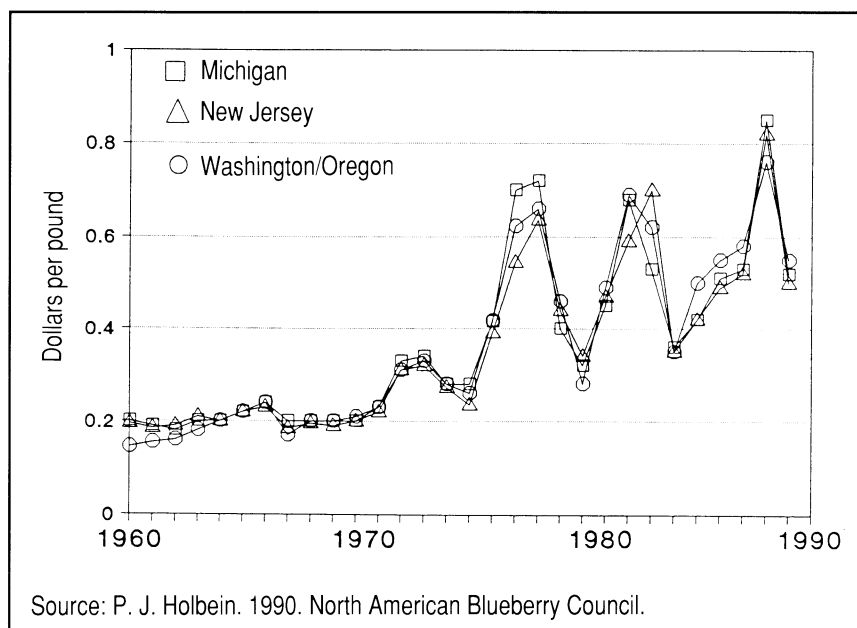

**Figure 23.** Trends in raw-product blueberry prices.

## Marketing Options

Blueberries are versatile and well suited to a variety of marketing techniques (figure 24). Numerous factors need to be considered in developing a marketing plan for a specific operation. Blueberries may be marketed wholesale as fresh or processed products. Marketing cooperatives have been established to sell the large volumes of fruit in most major production regions. Sale of berries for processing might be the easiest market to provide for, since some fruit quality requirements are less stringent and processed products are less perishable than fresh fruit.

Processed berries can also be harvested mechanically, reducing picking costs and the need for seasonal labor. However, processed blueberry prices are typically lower than fresh prices, so profit margins are often narrower.

Producers near large populations may find marketing directly to the consumer most rewarding. Direct sales include farm or roadside marketing and PYO. The primary advantage of direct marketing is that retail prices are higher than wholesale. However, direct marketers must assume liability for customers, provide parking and sales facilities, and have a flair for promotion and an ability to work with people.

### Wholesale Markets

Most highbush blueberries produced in North America are sold to retailers, food manufacturers, or institutions. The primary market areas have traditionally been in Boston, New York, Philadelphia, Detroit, Chicago, and cities in California. Because these outlets require a large volume of product, they are most effectively served by larger producers or marketing cooperatives.

Compared to growers of other fruits, relatively few blueberry growers deliver fruit to a processor who then assumes ownership and distributes the product. Many large independent blueberry growers perform all of these functions themselves, while smaller growers may join marketing cooperatives that

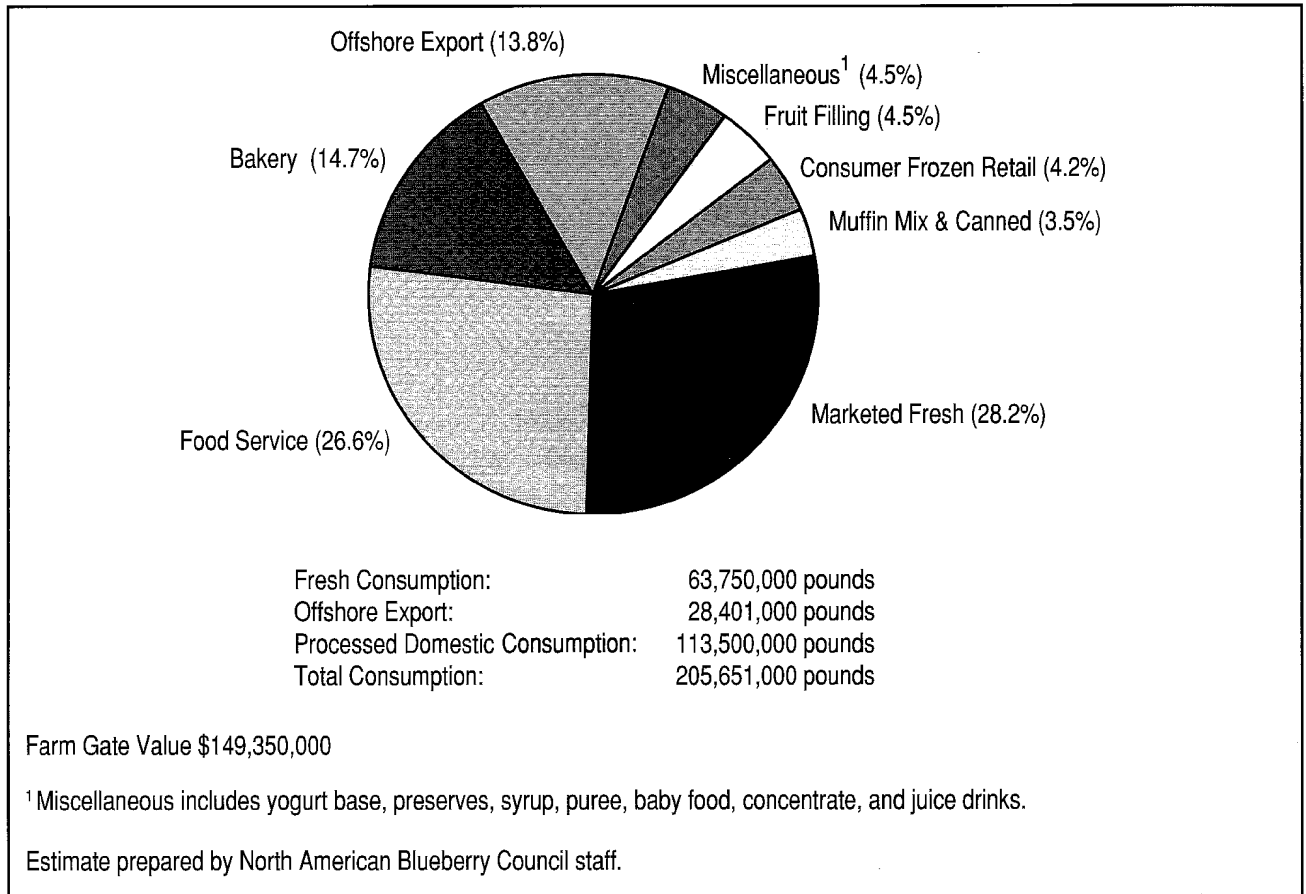

**Figure 24.** Utilization of 1989 North American blueberry production.

carry out these functions. Individual growers may also contract with shippers for a fixed charge. Shippers may then identify buyers and transport berries, or provide shipping only.

Cooperatives have been extremely effective in some regions because they allow growers to pool their production and meet the needs of larger buyers. Cooperatives also make more efficient use of promotion and advertising dollars, and allow growers to employ individuals with expertise in these fields. Cooperatives may be quite small with only a few members or large with many grower-members.

### **Direct Markets**

Blueberries can be marketed directly to consumers through PYO (photo 167), roadside, or on-farm sales. Many states have direct marketing or farm marketing associations that are valuable resources for those new to direct marketing. Effective direct marketing requires considerable planning, an appropriate location, and a sufficient customer base. Successful direct marketers have the ability to deal directly with customers daily.

Before deciding on direct marketing, assess your personality, farm resources, and location. Direct marketing requires long hours, particularly on week-ends. Successful marketers have good “people skills.” They are courteous and informed, and enjoy interacting with the public. Required farm facilities include parking, a market building or checkout area, and bathroom/wash facilities. An appropriate location is essential. The facility should be on an improved road either near an adequate population base or on a heavily

traveled route. Studies on PYO strawberries indicate that a population of 1,000 is needed within 30 miles to market the berries from an acre. Similar studies indicate that individuals are unlikely to drive more than 25 to 30 miles to visit a farm. However, markets may attract customers from greater distances in areas where few blueberries are grown. Tourism may provide additional customers in popular resort areas.

Start small. Begin direct marketing slowly and gradually increase the volume as you become familiar with the demand in the area. Successful marketers often develop their clientele over many years. Sales from a small shed or garage may provide a low-risk initial approach to direct marketing.

PYO has been a successful blueberry marketing technique for many people. Successful PYO farms share these common characteristics:

- Operators like people. They are friendly, honest and courteous. They give customers prompt and individual attention and instruct them in how to harvest, handle, and use berries.
- Farms are easy to find, neat and well kept. Parking is adequate for even the largest crowds.
- Plantings are well managed and fruit quality is high.

Several aspects of blueberry culture need to be modified to accommodate the needs and wishes of PYO customers. Often these requirements cost more and are inconvenient to the farmer. However, consumers in most areas of the country can obtain fresh blueberries in stores during the local harvest period, so PYO operators must provide customers a pleasant experience and high-quality berries at a reasonable price to compete with local stores (photo 168).

Variety selection is critical. Customers want large berries that look and taste good and are easy to pick. Varieties must also be chosen which extend the harvest season as much as possible (early, mid-, late season). Extremely late varieties may not be preferred in some regions since they ripen after the school year starts and customer numbers decline. Varieties that are reliable producers may be preferred over less consistent varieties with higher yield potentials. Consistent crops are needed to build a reliable customer base.

Pruning practices require close attention when customers pick their own fruit. Annual detailed pruning is needed to maintain berry size and ease of picking. Customers typically make larger purchases when picking is fast and easy. Prune to keep the bush open and the berries visible and accessible. Limit the height of bushes so customers can reach the berries. Keeping bushes short allows for air movement and makes picking conditions more comfortable during hot summer days. Regular pruning also improves the uniformity of ripening. Customers can be less discriminating and pick more quickly.

Keep plantings free of weeds. Berries on lower branches are hidden by weeds and usually lost. Air movement is reduced by weeds and plantings remain wet longer following heavy dew or rain. Row middles in PYO plantings are best maintained in a permanent sod cover. Closely mowed sod provides a pleasant picking environment and improves access following heavy rains.

## USDA Standards for Blueberry Grades

Standards have been developed by the United States Department of Agriculture for cultivated highbush blueberries. These do not apply to other types of blueberries, such as lowbush. Separate standards are used for fresh and frozen blueberries. This information was taken from the Federal Register of May 7, 1955 (20 F.R. 3096).

**Fresh Berries** Fresh berries are classified as “U.S. No. 1” if they meet the following requirements, or “unclassified” if they do not. For U.S. No. 1, berries must be of similar varietal characteristics (similar in color and shape) and practically clean of dirt, frass, and other foreign material. U.S. No. 1 berries must also be well colored (more than half of the berry surface blue, bluish-purple, purple, or bluish-black) and not overripe (soft, past commercial utility) or wet from juice from crushed, leaking, or decayed berries.

The following classifications are used to specify blueberry size. Not more than 10% of samples from a given lot may fail to meet the counts specified below for size classifications. For “U.S. No. 1,” counts cannot exceed 250 berries per cup.

Extra Large	fewer than 90 berries per cup
Large	90–129 berries per cup
Medium	130–189 berries per cup
Small	190–250 berries per cup

Limitations have been set for the number of “defects” in an individual 100-berry sample and per lot (total for several 100-berry samples). Defects include “injury” and “damage.” Specific defects considered “injury” include unclean berries; clusters of three or more joined cap stems with one or more attached berries; berries with attached stems; readily noticeable russeting on the skin of berries; readily noticeable scales; readily noticeable scars; berries

**Table 18.** Defect tolerances for fresh blueberries at shipping point.

NUMBER OF 100-BERRY SAMPLES	TOTAL NUMBER OF BERRIES IN COMPOSITE SAMPLE	TOTAL DEFECTS <sup>1</sup> Serious Damage, Damage, and Injury	DAMAGE <sup>1</sup> Including Serious Damage	SERIOUS DAMAGE <sup>1</sup> Including Decay
6	600	55	25	3
8	800	73	32	4
10	1,000	90	39	5
12	1,200	106	46	6
15	1,500	130	57	7
18	1,800	154	66	8
<b>Maximum Permitted in a 100-Berry Sample</b>		<b>13</b>	<b>7</b>	<b>1</b>

<sup>1</sup> Numbers indicate the maximum permitted in a composite sample.

**Table 19.** Defect tolerances for fresh berries en route or at destination.

NUMBER OF 100-BERRY SAMPLES	TOTAL NUMBER OF BERRIES IN COMPOSITE SAMPLE	TOTAL DEFECTS <sup>1</sup> Decay, Serious Damage, Damage, and Injury	DAMAGE <sup>1</sup> Serious Damage and Decay	SERIOUS DAMAGE <sup>1</sup>	DECAY <sup>1</sup>
6	600	59	28	3	3
8	800	76	35	4	3
10	1,000	94	43	5	4
12	1,200	110	50	6	4
15	1,500	135	61	7	5
18	1,800	160	72	8	6
<b>Maximum Permitted in a 100-Berry Sample</b>		<b>13</b>	<b>7</b>	<b>2</b>	<b>2</b>

<sup>1</sup> Numbers indicate the maximum permitted in a composite sample.

which are not well colored. Specific defects listed as “damage” include broken skins caused by stem cracks, bird tears, water splits, punctures, or mechanical means; berries which are over half green; wet berries; shriveling, when skin is wrinkled and berry shape is distorted; overripe berries (tables 18–19). “Serious damage” includes crushed, decayed, or moldy berries. The number of 100-berry samples examined is determined by the inspector and depends on the number of containers in a lot.

**Frozen Berries**

Frozen blueberries are assigned grades based on a numerical rating of color, absence of defects (table 20, next page), and character. The most points possible for each factor and the maximum total score are as follows.

Factor	Points
Color	20
Absence of defects	40
Character	40
Total score	100

Frozen Grade	Description
Grade A (U.S. Fancy)	Scores not less than 90 points. Has similar varietal characteristics, good character, and normal flavor and odor. Practically free from defects.
Grade B (U.S. Choice)	Scores not less than 80 points. Has similar varietal characteristics, reasonably good character, and normal flavor and odor. Reasonably free from defects.
Grade C (U.S. Standard)	Scores not less than 70 points. Has similar varietal characteristics, fairly good character, and normal flavor and odor. Fairly free from defects.
Grade D (Substandard)	Frozen blueberries which fail to meet requirements for Grade C.

Berries with very good color receive a score of 18 to 20 points and an A classification. These berries possess a practically uniform, bright, dark blue-purple color, and contain no more than 5% red-purple berries.

Berries with good color receive a score of 16 or 17 points and a B classification. “Good color” means berries have a reasonably uniform dark blue-purple color with not more than 10% of the berries red-purple in color.

Berries with fairly good color receive a score of 14 or 15 and a C classification. These berries are moderately variable in color, and contain not more than 20% red-purple berries. Berries which fail to meet the C classification receive a score below 14 and a SStd classification. Berries which are green or have a green cast are considered defects.

The degree of freedom from defects is rated on a scale of 0 to 40. Defects include leaves, large stems, foreign edible berries, green berries (those with a green cast or green color), cap stems (single or double stems with or without berries attached), cluster stems (3 or more joined stems), and undeveloped berries (mummified or pathologically defective). Berries which are practically free from defects score between 32 and 35 points (B classification). Lots which are fairly free of defects score between 28 and 31 points (C classification), and those which do not meet these requirements receive a SStd classification.

“Leaves” includes whole leaves and leafy material less than 0.5 square inch in size. “Defective berries” includes green berries, edible berries other than blueberries, and undeveloped or damaged berries. “Clusters” are several berries attached by their stems.

**Table 20.** Frozen blueberry scoring for absence of defects.

CLASSIFICATION	SCORE	MAXIMUM DEFECTS PERMITTED PER 16-OUNCE SAMPLE		
		LEAVES & STEMS	DEFECTIVE BERRIES	CLUSTERS
A	36–40	2	10	4
B	32–35	4	16	8
C	28–31	6	20	12
SStd	0–30	more than 6	more than 20	more than 12

Character of frozen berries is ranked on a scale of 0 to 40. Berries with good character receive an A classification and a score of 36 to 40. These berries are reasonably firm and fleshy, and whole, with no more than 6% by weight of berries crushed, mushy, or broken. Berries with reasonably good character score 32 to 35 points (B classification). These berries may be lacking in firmness and fleshy texture, but are reasonably whole (not more than 10% of berries can be crushed, mushy, or broken). Frozen berries with fairly good character score 28 to 31 points (C classification). Fairly good character is defined as fairly whole and intact, with not more than 20% by weight of berries crushed, mushy, or broken. Berries classified as B, C, or SStd for character shall not be graded above U.S. Grade B, C or SStd, regardless of the total score for the product.



## Chapter 16

# BLUEBERRY CROP BUDGETING

---

Money management is crucial to the survival of any business. Good accounting skills generally determine the survival of an operation. For growers who are considering blueberry production for the first time, estimates of establishment cost, cash flow, and payback period are essential for making a wise investment decision.

Budgeting is a means of reviewing receipts and expenses from current or anticipated production practices to judge the economic feasibility of the operation. In the simplest terms, a budget is a written plan which estimates future outcome in dollars. Growers should use this information to determine how available resources should be allocated to maximize net income.

The three basic types of budgets used in planning are whole-farm budgets, enterprise budgets, and partial budgets. Each type is used to solve a specific planning problem.

The whole-farm budget is a future plan for the entire farm, taking into account receipts and expenses from all enterprises. Whole-farm budgets are useful in determining the appropriate mix of enterprises needed to maximize returns. This type of budget is needed if a grower is interested in completely modifying a farm operation.

An enterprise budget is a plan for one specific enterprise. It accounts only for associated receipts and expenses of producing a certain product or performing a specific operation. Enterprise budgets provide the starting point for most farm planning and analysis problems. They are appropriate for growers who wish to add a new enterprise to an existing operation, such as beginning blueberry production on an existing farm site.

A partial budget determines the effect on net income of minor changes to an existing farm enterprise. If a grower wishes to change from processing to fresh market, a partial budget would be beneficial.

Budgets may be organized and presented in various formats. Separate tables or worksheets are typically used for each year of operation. Field operations occurring in a particular year, the month in which they occur, the type of equipment and labor used, the hours of equipment and labor used, and all associated costs should be known when developing a budget. Many software packages are available for those seeking budgeting assistance.

## Types of Costs

---

Costs of operations are divided into two types: fixed costs and variable costs.

**Fixed Costs** Fixed costs do not vary with the level of production or the amount of equipment use and include the cost of land, equipment, insurance, and interest. Other types of fixed costs, the so-called opportunity costs, are those incurred

by tying up money in land or equipment. Since a planting requires 8 years to reach full production, the cost of establishing the planting as well as the income this investment could have generated must be recovered during the productive life of the planting. These numbers give a grower a realistic idea of the actual costs of doing business and will help identify ways to improve efficiency of farm operations and increase net returns.

Fixed costs include depreciation of equipment, interest on investment, insurance, and housing. Often fixed costs for equipment are determined on an hourly basis by dividing the total annual fixed cost per machine by the number of hours of use per year for all farm enterprises combined. As a result, total fixed costs of a piece of machinery per hour will vary with the amount of use. Growers can then determine the cost of a particular field operation by multiplying the equipment hours per acre by the equipment per hour fixed costs (table 21, next page).

Machinery insurance, tax, and housing expenses are a function of the machine's new cost. Insurance charges should be budgeted whether the owner or an insurance company carries the risk. A tax rate should be included in the budget only if machinery is subject to personal property tax imposed by a state or local government. The housing expense represents the cost of sheltering machinery or the additional repairs required as a result of not sheltering machinery.

Although the calculation of equipment fixed costs is difficult, it is the only method that reliably determines the actual cost of ownership. This is useful for growers deciding whether to rent or buy equipment, since many growers do not have a good idea of the cost of ownership.

Land costs are a noncash expense and represent a type of fixed opportunity cost that an individual grower incurs by keeping land tied up in its current use. This opportunity cost represents a rental return that is lost as a result of the owner-operator farming the land instead of renting the land to a tenant. The amount of this opportunity cost is based upon typical rental agreements in the grower's area.

Machinery capital recovery and interest expenses represent yet another opportunity cost and are incurred when money is tied up in machinery. These expenses are based on the machine's cost, expected useful life, and salvage value, as well as the intermediate term interest rate, which is used to determine this opportunity cost.

Amortized establishment costs are also noncash expenses. They represent net costs incurred during the establishment years that must be recaptured during the productive years. This cost is calculated by amortizing the net establishment costs over the productive life of the investment at a specified interest rate. Summary tables are useful for categorizing all of these different costs for an individual year.

**Variable Costs** Variable costs vary directly with the level of production and machinery use, and consist of such items as fuel, oil, lubrication and repairs, hired labor, fertilizer, and spray materials. Also included are all rented or leased machinery and equipment, and all custom-hired operations.

**Table 21.** Summary of machinery ownership and operating costs.

MACHINERY	Purchase Price	Years to Trade	Annual Total Hours	\$/Hour										TOTAL OVERALL COST
				FIXED COSTS				VARIABLE COSTS						
				Depreciation <sup>1</sup>	Interest <sup>2</sup>	Insurance	Taxes	Housing	TOTAL	Repair	Fuel & Lube	TOTAL		
60 HP Tractor	\$20,000	15	400	3.33	3.01	0.21	0.00	0.45	7.00	5.03	3.20	8.23	15.23	
30 HP Tractor	15,000	15	250	4.00	3.28	0.23	0.00	0.49	8.00	4.38	1.60	5.98	13.98	
Boom Sprayer	4,000	15	100	2.67	2.19	0.15	0.00	0.33	5.34	1.31	0.00	1.31	6.65	
PTO Blast Spr.	5,000	15	150	2.22	1.83	0.13	0.00	0.27	4.45	1.92	0.00	1.92	6.37	
7' Rotary Mower	3,500	10	100	3.50	2.06	0.14	0.00	0.31	5.70	2.04	0.00	2.04	7.74	
Spreader	1,500	15	40	5.00	2.05	0.14	0.00	0.31	7.50	0.70	0.00	0.70	8.20	
7' Plow	2,000	10	60	3.33	1.96	0.14	0.00	0.00	5.43	2.47	0.00	2.47	7.90	
8' Harrow	800	10	20	4.00	2.35	0.16	0.00	0.00	6.51	0.42	0.00	0.42	6.93	
9' Disc	2,500	10	20	12.50	7.36	0.51	0.00	0.00	20.37	1.66	0.00	1.66	22.03	
Transplanter	4,000	15	50	5.33	4.38	0.31	0.00	0.00	10.02	2.03	0.00	2.03	12.05	
PTO Rototiller	6,500	10	50	13.00	7.65	0.54	0.00	0.00	21.19	5.99	0.00	5.99	27.18	
Mulcher	12,000	12	100	10.00	6.77	0.47	0.00	1.02	18.26	4.91	1.60	6.51	31.28	
Utility Trailer	2,500	15	100	1.67	1.38	0.10	0.00	0.00	3.15	0.63	0.00	0.63	3.78	
Hay Rake	2,200	15	70	2.10	1.72	0.12	0.00	0.00	3.94	1.74	0.00	1.74	5.68	
Cultivator	1,500	15	160	0.63	0.51	0.04	0.00	0.00	1.18	0.90	0.00	0.90	2.08	
Side Dresser	500	15	80	0.42	0.34	0.02	0.00	0.00	0.78	0.31	0.00	0.31	1.09	
Fumigator	3,500	15	20	11.67	9.54	0.67	0.00	1.43	23.31	2.17	0.00	2.17	25.48	
PTO Multivator	5,000	15	100	3.33	2.74	0.19	0.00	0.41	6.67	2.60	0.00	2.60	9.27	
½ Ton Pickup	12,000	6	350	5.71	2.42	0.17	0.00	0.36	8.66	1.63	0.00	1.63	10.29	
Misc. Tools	2,500	10	100	2.50	1.62	0.11	0.00	0.24	4.47	0.91	0.00	0.91	5.38	

<sup>1</sup> Depreciation assumes no salvage value or trade value after 15 years. Depreciation is calculated, in dollars per hour, as  $\frac{\text{purchase price}}{\text{years to trade} \times \text{annual total hours}}$

<sup>2</sup> Interest is the cost of having capital tied up in buildings and equipment instead of invested in an interest-bearing account at 10%.

Original data collected by M. Pritts and M. Castaldi.

Variable costs include most harvest-related activities such as picking labor, picker transportation, and supervision. When developing a budget worksheet, it is helpful to present all variable costs on a cost per hour basis. Multiply these hourly costs by the number of hours each machine is used per year or per acre to find the total annual variable costs and costs per acre.

## ***Blueberry Enterprise Budget***

---

Blueberries are grown throughout the world under a wide range of conditions. They can be mechanically harvested for processing, hand harvested for the fresh market, or sold in pick-your-own operations. Some growers rely solely on blueberries for their income, while others manage a fruit and vegetable operation that includes blueberries. The variations in blueberry businesses make it impossible to develop a general enterprise budget for blueberries. Growers should work with economists to develop budgets that suit their needs.

Regardless of the type of operation, the economics of blueberry production has 3 characteristics.

- Establishment costs are very high. First-year cost estimates range from approximately \$4,000 to \$6,000 per acre. This includes the cost of land preparation (\$1,200), plants (\$1,800), and associated labor costs. Additional costs are incurred for irrigation. In some regions, irrigation water is inexpensive. If drip irrigation is used in these regions, then per-acre irrigation costs can be less than \$1,000. At the other extreme, if sprinkler irrigation is used where water is more expensive, irrigation costs can range up to \$3,000. If deer browsing or bird depredation are intolerable without fencing or netting, then additional costs of approximately \$1,200 will be incurred for each.
- The payback period is very long. Blueberries are slow to produce a commercially harvestable crop, and about 8 years are required for a planting to reach full production. During this time, maintenance costs are accumulating. Each year between \$2,000 and \$3,000 per acre is spent for crop protectants, weed control, fertilization, irrigation, mulching, and other maintenance items. The greatest part of total annual operating costs represents harvesting, packaging, and marketing. For hand-harvested fruit, as much as \$4,000 per acre can be spent for labor and packaging in a mature planting. For PYO harvest, as little as \$900 per acre is required. Harvesting fruit mechanically costs about \$2,000 per acre. From an economist's viewpoint, costs are also incurred from previously invested money that is not earning a return. This ranges from \$300 to \$600 annually, or about 10% of the initial investment. When all of these costs are taken into account, at least 5 years of production are required to recover basic establishment costs. As many as 13 years of production are required to recover irrigation, fencing, and netting costs as well.
- The investment is generally profitable. Despite the lengthy payback period that can make blueberries an unattractive investment, their long productive life, low maintenance costs (relative to establishment costs), and favorable market generally make blueberries a profitable

investment over the long term. Net returns of nearly \$1,200 per acre have been reported in North Carolina, \$4,000 per acre in New Jersey, and \$8,000 per acre in Washington. These numbers fluctuate annually with price, weather, and location.

## ***Developing Your Own Budget***

---

To develop your own budget, you should have estimates of both the fixed and variable costs associated with the blueberry operation for each year of production (tables 22–27). With the help of computer software or an economist, cash flow projections, net returns and net present value can be calculated. An investment in blueberries can then be compared with other types of investments.

For an operation to survive in the short run (up to 8 years), total revenues from other farm operations must be high enough to cover the total variable costs of blueberry growing, unless the planting is financed with debt or equity capital is used to offset losses during the establishment years. If total revenues never exceed total variable costs, blueberry production should be stopped. Variable costs will then be eliminated and losses will be minimized.

For long-term survival, total revenues from farm operations must be high enough to cover total variable costs, plus total fixed costs such as depreciation, interest on investment, net land rent, and amortized establishment costs. Noncash fixed expenses such as depreciation represent the costs associated with gradual deterioration of machinery and equipment. Other noncash costs, such as interest on investment, net land rent, and interest on establishment cost, represent the opportunity cost to the owner-operator of having funds tied up in their current uses. For long-run profitability, total farm revenues must cover these costs to provide a return to equity capital invested in land, plants, machinery, equipment, and buildings.

Tables 21 through 27 account for most costs that might be incurred by a grower purchasing or renting land, equipment, and plants for the first time. Therefore, the costs are at the high end of the range. Costs for a typical blueberry grower will be lower. Tables are most useful for identifying all the costs that are involved in blueberry production.

## ***Case Study***

---

Data provided on tables 22–27 were obtained from fruit growers in eastern New York State in 1988. The average farm size was 200 acres, with 5 acres of blueberries. The life expectancy for the blueberry planting was 30 years, with full production occurring in the ninth year after site preparation. Equipment operators were paid \$6.50 per hour and other labor was paid \$5.50 per hour. Blueberry fruit was hand harvested, either through PYO or custom harvest. A cost of \$0.15 per pound was assessed for PYO operations to account for advertising, field supervision, and check-out. Custom harvesting costs were \$0.60 per pound. A solid-set irrigation system was factored into the analysis. Equipment was assumed to be purchased new in the year when it was needed. Yields were assumed to be 6,000 pounds per acre in years 9 through 30. Yields in years 4 through 8 were assumed to be 500, 1,000, 2,000, 3,000, and 4,500 pounds per acre, respectively.

Production costs in the Hudson Valley are very high, and the price of blueberries tends to be depressed because of the close proximity to New Jersey. For these reasons, net returns were estimated conservatively. Profits should be higher in most locations.

Total costs for bringing the planting into full production by Year 9 were \$27,212, and net establishment costs were \$13,613. In this study, a positive cash flow was realized after Year 10 with commercial harvesting, and Year 13 with PYO. The break-even price was \$0.68 per pound PYO and \$1.12 per pound for custom harvesting. Actual prices in 1988 averaged \$0.80 per pound for PYO and \$1.40 per pound for custom harvest. Net returns were estimated to be \$720 for PYO and \$1,680 for custom harvest.

Growers should use this study for comparative purposes only, and are advised to do their own analysis using the prices, yields, costs, and situations faced on their own farms. Chemicals listed in the tables are those used by growers in 1988 and may not be currently labeled for use with blueberries. They are not recommendations.

**Table 22.** Schedule of operations and cost per acre from the Hudson Valley study (Year 1—Site Preparation).

OPERATION	TOOLING	MONTH	Machinery Hours <sup>1</sup>	Labor Hours <sup>2</sup>	TOTAL FIXED COSTS	VARIABLE COSTS						TOTAL COST	
						Fuel, Oil		Machinery		Service <sup>5</sup>	Materials <sup>6</sup>		TOTAL
						Lube, & Repairs <sup>3</sup>	Labor <sup>4</sup>						
Sample Soil	Hand Labor & Soil Auger	May	—	—	—	—	—	25.50	—	—	25.50	25.50	
Apply Herbicide	30 HP-WT & Boom Sprayer	June	0.40	0.48	5.39	3.18	3.12	—	45.00	—	51.30	56.69	
Plow Field	60 HP-WT & 7' Plow	June	1.10	1.33	13.79	12.67	8.65	—	—	—	21.32	35.11	
Apply Nutrients	60 HP-WT & Spreader	June	0.35	0.42	4.36	3.43	2.73	—	583.50	—	589.66	594.02	
Disc Field	60 HP-WT & Disc	July	0.55	0.67	14.20	5.89	4.36	—	—	—	10.25	24.45	
Harrow Field	60 HP-WT & 8' Harrow	July	0.45	0.54	6.08	4.26	3.51	—	—	—	7.77	13.85	
Seed Grnd Cover	30 HP-WT & Spreader	July	0.25	0.30	3.29	1.82	1.95	—	12.50	—	16.27	19.56	
Mow Grnd Cover	30 HP-WT & 7' Rotary Mower	Sept	0.50	0.61	6.89	4.33	3.97	—	—	—	8.30	15.19	
Taxes	Real Estate Taxes	Annual	—	—	14.00	—	—	—	—	—	—	14.00	
Management	Management Fee	Annual	—	—	—	—	—	100.00	—	—	100.00	100.00	
Land Cost	Net Land Rent	Annual	—	—	200.00	—	—	—	—	—	—	200.00	
Miscellaneous	Miscellaneous Costs	Annual	—	—	—	—	—	20.00	—	—	20.00	20.00	
Overhead	Utilities, Legal, Acct., Etc.	Annual	—	—	—	—	—	15.00	—	—	15.00	15.00	
Pickup	½ Ton Pickup	Season	2.00	2.20	12.63	3.25	14.30	—	—	—	17.55	30.18	
Misc. Tools	Misc. Hand Tools	Season	2.00	2.20	7.47	1.82	14.30	—	—	—	16.12	23.59	
Interest	Operating Capital	Season	—	—	—	—	—	15.07	—	—	15.07	15.07	
<b>Total Per Acre</b>			<b>7.60</b>	<b>8.75</b>	<b>288.10</b>	<b>40.65</b>	<b>56.89</b>	<b>175.57</b>	<b>641.00</b>	<b>914.11</b>	<b>1,202.21</b>		

<sup>1</sup> Hours to operate the required machinery per acre for the specific farming operation.

<sup>2</sup> Hours of labor required to operate the required machinery per acre.

<sup>3</sup> Cost per acre of operating equipment, excluding labor costs.

<sup>4</sup> Cost per acre of labor to operate machinery at \$6.50 per hour.

<sup>5</sup> Cost per acre of contracted service.

<sup>6</sup> Cost per acre of materials associated with the specific farming operation.

Original data collected by M. Pritts and M. Castaldi.

**Table 23.** Summary of production costs per acre from the Hudson Valley study (Year 1—Site Preparation).

COSTS	UNIT	PRICE or COST/UNIT	QUANTITY	VALUE or COST	YOUR FARM
<b>Variable Costs</b>					
Labor Collect Soil Samples	Hour	5.50	1.00	5.50	_____
Soil Analysis	Sample	20.00	1.00	20.00	_____
Roundup	Gallon	90.00	0.50	45.00	_____
Sulfur	Pound	0.35	1,000.00	350.00	_____
Sul-Po-Mag	Pound	0.13	750.00	97.50	_____
Superphosphate	Pound	0.68	200.00	136.00	_____
Grass Seed	Pound	1.25	10.00	12.50	_____
Management	Acre	100.00	1.00	100.00	_____
Miscellaneous	Acre	40.00	0.50	20.00	_____
Overhead	Acre	30.00	0.50	15.00	_____
Interest on Op.Cap.	Dollar	0.10	150.65	15.07	_____
Tractors Repair	Acre	19.09	1.00	19.09	_____
Tractors Fuel/Lube	Acre	10.66	1.00	10.66	_____
Machinery Repairs	Acre	10.85	1.00	10.85	_____
Labor (Tractor/Machinery)	Hour	6.50	8.76	56.94	_____
<b>Total Variable Cost</b>				<b>\$914.11</b>	_____
<b>Fixed Costs</b>					
Tractors Depreciation	Acre	13.52	1.00	13.52	_____
Tractors Interest	Acre	12.27	1.00	12.27	_____
Tractors Insurance	Acre	0.86	1.00	0.86	_____
Tractors Taxes	Acre	0.00	1.00	0.00	_____
Tractors Housing	Acre	1.84	1.00	1.84	_____
Machinery Depreciation	Acre	24.16	1.00	24.16	_____
Machinery Interest	Acre	18.48	1.00	18.48	_____
Machinery Insurance	Acre	1.29	1.00	1.29	_____
Machinery Taxes	Acre	0.00	1.00	0.00	_____
Machinery Housing	Acre	1.68	1.00	1.68	_____
Real Estate Taxes	Acre	14.00	1.00	14.00	_____
Net Land Rent	Acre	200.00	1.00	200.00	_____
<b>Total Fixed Cost</b>				<b>\$ 288.10</b>	_____
<b>TOTAL COST</b>				<b>\$1,202.21</b>	_____

Original data collected by M. Pritts and M. Castaldi.



**Table 24.** Schedule of operations and costs per acre, from the Hudson Valley study (Year 2—Planting).

OPERATION	TOOLING	MONTH	VARIABLE COSTS						TOTAL COST			
			Machinery Hours <sup>1</sup>	Labor Hours <sup>2</sup>	TOTAL FIXED COSTS	Fuel, Oil Lube, & Repairs <sup>3</sup>	Machinery Labor <sup>4</sup>	Service <sup>5</sup>		Materials <sup>6</sup>	TOTAL	
Rototill Strips	60 HP-WT & PTO Rototiller	Mar	1.00	1.21	26.59	15.04	7.87	—	—	—	22.91	49.50
Layout & Stake	Hand Labor & Misc. Tools	Mar	—	—	—	—	—	22.00	180.00	—	202.00	202.00
Haul Plants	½ Ton Pickup & Trailer	Apr	1.00	1.10	9.28	2.26	7.15	—	—	—	9.41	18.69
Plant Berries	Hand Labor & Misc. Tools	Apr	—	—	—	—	—	165.00	1,920.00	—	2,085.00	2,085.00
Irrig. Startup	Set-up Irrig. Equipment	Apr	1.00	1.10	9.28	2.26	7.15	5.50	—	—	14.91	24.19
Apply Mulch	60 HP-WT, Trailer & Hand Labor	Apr	1.50	1.82	15.99	14.53	11.83	11.00	250.00	—	287.36	303.35
Remove Flowers	Hand Labor	May	—	—	—	—	—	11.00	—	—	11.00	11.00
Irrigate	Solid Set Irrig. System	May–Sep	—	—	250.00	—	—	—	25.00	—	25.00	275.00
Hand Hoe	Hand Labor & Misc. Tools	June	—	—	—	—	—	16.50	—	—	16.50	16.50
Mow Grnd Cover	30 HP-WT & 7' Rotary Mower	June	0.50	0.61	6.89	4.28	3.97	—	—	—	8.28	15.17
Hand Hoe	Hand Labor & Misc. Tools	Aug	—	—	—	—	—	27.50	—	—	27.50	27.50
Mow Grnd Cover	30 HP-WT & 7' Rotary Mower	Aug	0.50	0.61	6.89	4.28	3.97	—	—	—	8.28	15.17
Irrig. Shut down	Take Down Irrig., Equip.	Sept	1.00	1.10	9.28	2.26	7.15	5.50	—	—	14.91	24.19
Taxes	Real Estate Taxes	Annual	—	—	16.00	—	—	—	—	—	—	16.00
Management	Management Fee	Annual	—	—	—	—	—	100.00	—	—	100.00	100.00
Land Cost	Net Land Rent	Annual	—	—	200.00	—	—	—	—	—	—	200.00
Miscellaneous	Miscellaneous Costs	Annual	—	—	—	—	—	30.00	—	—	30.00	30.00
Overhead	Utilities, Legal, Acct., Etc.	Annual	—	—	—	—	—	22.50	—	—	22.50	22.50
Investment	Interest on Accum. Invest.	Annual	—	—	120.22	—	—	—	—	—	—	120.22
Pickup	½ Ton Pickup	Season	4.00	4.40	25.25	6.51	28.60	—	—	—	35.11	60.36
Misc. Tools	Misc. Hand Tools	Season	3.00	3.30	11.21	2.71	21.45	—	—	—	24.18	35.39
Interest	Operating Capital	Season	—	—	—	—	—	83.31	—	—	83.31	83.31
<b>Total Per Acre</b>			<b>13.50</b>	<b>15.25</b>	<b>706.88</b>	<b>54.13</b>	<b>99.14</b>	<b>499.81</b>	<b>2,375.00</b>	<b>—</b>	<b>3,028.08</b>	<b>3,734.96</b>

<sup>1</sup> Hours to operate the required machinery per acre for the specific farming operation.

<sup>2</sup> Hours of labor required to operate the required machinery per acre.

<sup>3</sup> Cost per acre of operating equipment, excluding labor costs.

<sup>4</sup> Cost per acre of labor to operate machinery at \$6.50 per hour.

<sup>5</sup> Cost per acre of contracted service.

<sup>6</sup> Cost per acre of materials associated with the specific farming operation.

Original data collected by M. Pritts and M. Castaldi.

**Table 25.** Summary of production costs per acre from the Hudson Valley study (Year 2—Planting).

COSTS	UNIT	PRICE or COST/UNIT	QUANTITY	VALUE or COST	YOUR FARM
<b>Variable Costs</b>					
Labor Lay Out Field	Hour	5.50	4.00	22.00	_____
Stakes	Stake	0.15	1,200.00	180.00	_____
Labor Plant Berries	Hour	5.50	30.00	165.00	_____
Blueberry Plants	Plant	1.60	1,200.00	1,920.00	_____
Labor Set Up Irrigation	Hour	5.50	1.00	5.50	_____
Wood Chips	Pound	0.05	5,000.00	250.00	_____
Labor Apply Mulch	Hour	5.50	2.00	11.00	_____
Labor Remove Flowers	Hour	5.50	2.00	11.00	_____
Irrig. Operating Costs	Acre	25.00	1.00	25.00	_____
Labor Hand Hoe	Hour	5.50	3.00	16.50	_____
Labor Hand Hoe	Hour	5.50	5.00	27.50	_____
Labor Take Down Irrig.	Hour	5.50	1.00	5.50	_____
Management	Acre	100.00	1.00	100.00	_____
Miscellaneous	Acre	40.00	0.75	30.00	_____
Overhead	Acre	30.00	0.75	22.50	_____
Interest on Op.Cap.	Dollar	0.10	833.06	83.31	_____
Tractors Repair	Acre	18.64	1.00	18.64	_____
Tractors Fuel & Lube	Acre	10.57	1.00	10.57	_____
Machinery Repairs	Acre	25.00	1.00	25.00	_____
Labor (Tractor/Mach.)	Hour	6.50	15.24	99.06	_____
<b>Total Variable Cost</b>				<b>\$3,028.08</b>	_____
<b>Fixed Costs</b>					
Tractors Depreciation	Acre	13.11	1.00	13.11	_____
Tractors Interest	Acre	11.89	1.00	11.89	_____
Tractors Insurance	Acre	0.83	1.00	0.83	_____
Tractors Taxes	Acre	0.00	1.00	0.00	_____
Tractors Housing	Acre	1.78	1.00	1.78	_____
Machinery Depreciation	Acre	49.12	1.00	49.12	_____
Machinery Interest	Acre	37.71	1.00	37.71	_____
Machinery Insurance	Acre	2.64	1.00	2.64	_____
Machinery Taxes	Acre	0.00	1.00	0.00	_____
Machinery Housing	Acre	3.58	1.00	3.58	_____
Irrigation Equipment	Acre	250.00	1.00	250.00	_____
Real Estate Taxes	Acre	16.00	1.00	16.00	_____
Net Land Rent	Acre	200.00	1.00	200.00	_____
Interest on Investment	Dollar	0.10	1,202.19	120.22	_____
<b>Total Fixed Cost</b>				<b>\$706.88</b>	_____
<b>Total Cost</b>				<b>\$3,734.96</b>	_____

**Table 26.** Schedule of operations and costs per acre from the Hudson Valley study (Year 9—Full Production).

OPERATION	TOOLING	MONTH	VARIABLE COSTS							TOTAL FIXED COSTS	Fuel, Oil Lube,& Repairs	Machinery Labor	Service	Materials	TOTAL	TOTAL COST
			Machinery Hours	Labor Hours	Machinery Labor	Service	Materials	TOTAL								
Hand Prune	Hand Labor & Shears	Mar	—	—	—	—	—	—	—	—	—	52.00	—	—	52.00	52.00
Fertilize	30 HP-WT & Spreader	Mar	0.25	0.30	—	1.82	3.29	—	1.82	1.97	—	—	36.00	—	39.79	43.08
Apply Mulch	60 HP-WT, Trailer & Hand Labor	Apr	1.50	1.82	—	14.51	15.99	—	14.51	11.80	11.00	—	150.00	—	187.31	203.30
Dormant Spray	30 HP-WT & PTO Blast Sprayer	Apr	0.40	0.48	—	3.40	5.05	—	3.40	3.15	—	—	16.50	—	23.05	28.10
Irrig. Start-Up	Set Up Irrig. System	Apr	1.00	1.10	—	2.26	9.28	—	2.26	7.15	5.50	—	—	—	14.91	24.19
Mow Grnd Cover	30 HP-WT & 7' Rotary Mower	May	0.50	0.61	—	4.31	6.89	—	4.31	3.93	—	—	—	—	8.24	15.13
Bee Rental	Beehive Rental	May	—	—	—	—	—	—	—	—	—	—	25.00	—	25.00	25.00
Bloom Spray	30-HP WT & PTO Blast Sprayer	May	0.40	0.48	—	3.40	5.05	—	3.40	3.15	—	—	20.23	—	26.78	31.83
Irrigate	Hand Labor & Drip Irrig. System	May-Sep	—	—	—	—	250.00	—	—	—	—	—	25.00	—	25.00	275.00
1st Cover Spray	30 HP-WT & PTO Blast Sprayer	June	0.40	0.48	—	3.40	5.05	—	3.40	3.15	—	—	14.75	—	21.30	26.35
Harvest Prep	PYO Harvest Preparation	June	1.00	1.10	—	1.63	6.31	—	1.63	7.15	13.75	—	—	—	22.53	28.84
Misc. Harvest	Superv., Checkout, Advert., Etc.	June	—	—	—	—	—	—	—	—	900.00	—	—	—	900.00	900.00
Hand Hoe	Hand Labor & Misc. Tools	June	—	—	—	—	—	—	—	—	33.00	—	—	—	33.00	33.00
Mow Grnd Cover	30 HP-WT & 7' Rotary Mower	June	0.50	0.61	—	4.31	6.89	—	4.31	3.93	—	—	—	—	8.24	15.13
2nd Cover Spray	30 HP-WT & PTO Blast sprayer	July	0.40	0.48	—	3.40	5.05	—	3.40	3.15	—	—	8.00	—	14.55	19.60
Mow Grnd Cover	30 HP-WT & 7' Rotary Mower	July	0.50	0.61	—	4.31	6.89	—	4.31	3.93	—	—	—	—	8.24	15.13
Harvest Cleanup	PYO Harvest Cleanup	July	1.00	1.10	—	1.63	6.31	—	1.63	7.15	8.25	—	—	—	17.03	23.34
Leaf Analysis	Hand Labor	Aug	—	—	—	—	—	—	—	—	25.50	—	—	—	25.50	25.50
Hand Hoe	Hand Labor & Misc. Tools	Aug	—	—	—	—	—	—	—	—	33.00	—	—	—	33.00	33.00
Mow Grnd Cover	30 HP-WT & 7' Rotary Mower	Aug	0.50	0.61	—	4.31	6.89	—	4.31	3.93	—	—	—	—	8.24	15.13
Irrig. Shutdown	Take Down Irrig. Equip.	Sept	—	1.00	—	1.63	6.31	—	1.63	7.15	5.50	—	—	—	14.28	20.59
Apply Herbicide	30 HP-WT & Boom Sprayer	Oct	—	0.48	—	3.15	5.39	—	3.15	3.15	—	—	101.95	—	108.25	113.64
Taxes	Real Estate Taxes	Annual	—	—	—	—	20.00	—	—	—	—	—	—	—	—	20.00
Management	Management Fee	Annual	—	—	—	—	—	—	—	—	100.00	—	—	—	100.00	100.00
Land Cost	Net Land Rent	Annual	—	—	—	—	200.00	—	—	—	—	—	—	—	—	200.00
Miscellaneous	Miscellaneous Costs	Annual	—	—	—	—	—	—	—	—	40.00	—	—	—	40.00	40.00
Overhead	Utilities Legal Acct. Etc.	Annual	—	—	—	—	—	—	—	—	30.00	—	—	—	30.00	30.00
Investment	Interest on Accum. Invest.	Annual	—	—	—	—	1,599.50	—	—	—	—	—	—	—	—	1,599.50
Pickup	1/2 Ton Pickup	Season	10.00	11.00	—	16.27	63.13	—	16.27	71.50	—	—	—	—	87.77	150.90
Misc. Tools	Misc. Hand Tools	Season	8.00	8.80	—	7.27	29.90	—	7.27	57.20	—	—	—	—	64.47	94.37
Interest	Operating Capital	Season	—	—	—	—	—	—	—	—	43.94	—	—	—	43.94	43.94
<b>Total Per Acre</b>			<b>26.35</b>	<b>31.06</b>	<b>81.04</b>	<b>2,263.17</b>	<b>1,301.44</b>	<b>397.43</b>	<b>1,982.45</b>	<b>4,245.59</b>						

**Table 27.** Summary of production costs per acre from the Hudson Valley study (Year 9—Full Production, PYO).

COSTS	UNIT	PRICE or COST/UNIT	QUANTITY	VALUE or COST	YOUR FARM
<b>Variable Costs</b>					
PREHARVEST					
Labor Hand Pruning	Hour	6.50	8.00	52.00	_____
Ammonium Sulfate	Pound	0.12	300.00	36.00	_____
Wood Chips	Pound	0.05	3,000.00	150.00	_____
Labor Apply Mulch	Hour	5.50	2.00	11.00	_____
Spray Oil	Gallon	2.75	6.00	16.50	_____
Irrig. Equip. Startup	Hour	5.50	1.00	5.50	_____
Beehive	Hive	25.00	1.00	25.00	_____
Guthion	Pound	4.50	1.50	6.75	_____
Benlate	Pound	10.95	0.50	5.48	_____
Folpet	Pound	2.00	4.00	8.00	_____
Irrig. Operating Costs	Acre	25.00	1.00	25.00	_____
Folpet	Pound	2.00	4.00	8.00	_____
Guthion	Pound	4.50	1.50	6.75	_____
Folpet	Pound	2.00	4.00	8.00	_____
Management	Acre	100.00	1.00	100.00	_____
Miscellaneous	Acre	40.00	1.00	40.00	_____
Overhead	Acre	30.00	1.00	30.00	_____
Interest on Op. Cap.	Dollar	0.10	439.40	43.94	_____
Tractors Repair	Acre	18.75	1.00	18.75	_____
Tractors Fuel/Lube	Acre	9.24	1.00	9.24	_____
Machinery Repairs	Acre	32.06	1.00	32.06	_____
Labor (Tractor/Machinery)	Hour	6.50	25.56	166.11	_____
<b>Subtotal, Preharvest</b>				<b>\$ 804.08</b>	_____
HARVEST					
Labor Harvest Prep	Hour	5.50	2.50	13.75	_____
Misc Harvest and Advertising <sup>1</sup>	Pound	0.15	6,000.00	900.00	_____
Labor Cleanup	Hour	5.50	1.50	8.25	_____
Machinery Repairs	Acre	3.25	1.00	3.25	_____
Labor (Tractor/Machinery)	Hour	6.50	2.20	14.30	_____
<b>Subtotal, Harvest</b>				<b>\$939.55</b>	_____
POSTHARVEST					
Labor Hand Hoe	Hour	5.50	6.00	33.00	_____
Labor Collect Leaf Samples	Hour	5.50	1.00	5.50	_____
Leaf Analysis	Sample	20.00	1.00	20.00	_____

[continued on next page]

<sup>1</sup> For calculating costs of commercial harvest, price per pound is assumed to be \$0.60.

**Table 27—continued**

Labor Hand Hoe	Hour	5.50	6.00	33.00	_____
Irrig. Equip. Shutdown	Hour	5.50	1.00	5.50	_____
Kerb	Gallon	13.60	2.00	27.20	_____
Surflan	Pound	13.85	5.00	69.25	_____
Princep	Pound	2.75	2.00	5.50	_____
Tractors Repair	Acre	9.31	1.00	9.31	_____
Tractors Fuel/Lube	Acre	3.40	1.00	3.40	_____
Machinery Repairs	Acre	5.03	1.00	5.03	_____
Labor (Tractor/Machinery)	Hour	6.50	3.40	22.07	_____
<b>Subtotal, Postharvest</b>				<b>\$238.76</b>	_____
<b>Total Variable Cost</b>				<b>\$1,982.39</b>	_____
<b>Fixed Costs</b>					
Tractors Depreciation	Acre	22.40	1.00	22.40	_____
Tractors Interest	Acre	20.33	1.00	20.33	_____
Tractors Insurance	Acre	1.42	1.00	1.42	_____
Tractors Taxes	Acre	0.00	1.00	0.00	_____
Tractors Housing	Acre	3.05	1.00	3.05	_____
Machinery Depreciation	Acre	75.39	1.00	75.39	_____
Machinery Interest	Acre	58.71	1.00	58.71	_____
Machinery Insurance	Acre	4.11	1.00	4.11	_____
Machinery Taxes	Acre	0.00	1.00	0.00	_____
Machinery Housing	Acre	8.29	1.00	8.29	_____
Irrigation Equipment	Acre	250.00	1.00	250.00	_____
Real Estate Taxes	Acre	20.00	1.00	20.00	_____
Net Land Rent	Acre	200.00	1.00	200.00	_____
Amortized Estab. Cost	Dollar	0.1175	13,612.74	1,599.50	_____
<b>Total Fixed Cost</b>				<b>\$2,263.20</b>	_____
<b>TOTAL COST</b>				<b>\$4,245.59</b>	_____

Original data collected by M. Pritts and M. Castaldi.

## Appendix 1

# CALCULATING CATION EXCHANGE CAPACITY OF A SOIL

$$\text{CEC} = \text{Exchangeable acidity} + \text{bases}$$

From the soil test results, find the amount of calcium, potassium, and magnesium (in pounds per acre) and convert to units of milliequivalents per 100 grams. (This assumes a 6.67-inch furrow slice, or 2 million pounds of soil per acre.)

Pounds/acre of calcium $\div$ 400	=	_____	(meq/100g)
Pounds/acre of magnesium $\div$ 243	=	_____	
Pounds/acre of potassium $\div$ 782	=	_____	
Total bases		_____	

Sample calculation:

New York sandy loam soil of pH = 5.4 with soil test values of 1,600 lb/A calcium, 480 lb/A magnesium, and 200 lb/A potassium; exchangeable acidity unknown.

1,600 $\div$ 400	=	4.0
480 $\div$ 243	=	2.0
200 $\div$ 782	=	0.3
Total bases		6.3

Estimated CEC is 6.3  $\div$  42% (from table), or 15.0. Percent base saturation from calcium is 4.0  $\div$  15.0, or 26%.

This soil is probably suitable for blueberry production assuming drainage is adequate. It has a CEC of less than 18, a calcium level of less than 2,000 lb/A, and a percent base saturation from calcium near 20%.

Approximate sulfur requirements can be obtained from table 4 (page 20).

Some soil testing labs estimate the meq exchangeable acidity. If the exchangeable acidity is available, it can be added to the sum above for an estimate of the cation exchange capacity (CEC). If the meq exchangeable acidity is not available, the CEC can still be estimated from the expected base saturation of the cation exchange capacity, which is dependent on soil pH. The estimated CEC is the total bases divided by the expected base

saturation. Unfortunately, the relationship between soil pH and percent base saturation of the CEC differs from one soil type to another, depending on clay content and organic matter. For a typical New York soil, the relationship is as follows:

Soil pH	% base saturation	Soil pH	% base saturation
8.0	96	5.4	42
7.5	86	5.2	30
7.0	80	5.1	23
6.5	70	5.0	15
6.0	62	4.9	9
5.8	57	4.8	7
5.6	50	4.6	2
		4.5	0

For a typical Missouri blueberry soil:

Soil pH	% base saturation	Soil pH	% base saturation
8.0	99	5.4	72
7.5	98	5.2	68
7.0	95	5.1	66
6.5	90	5.0	63
6.0	83	4.9	61
5.8	80	4.8	58
5.6	76	4.6	53
		4.5	50

The CECs of various New York soils are usually close to the following values.

Management Group	CEC
I (clays)	25
II	20
III (loams)	18
IV	16
V (sands)	12

Acidification with sulfur may not be practical for soils with CECs greater than 18.

To determine the percent base saturation attributed to calcium, divide the calcium value (meq/100 g) by the CEC. Blueberry production may not be feasible if this number is significantly greater than 20%.

**Summary** Criteria for a blueberry soil

- Clay and/or silt content of less than 20%
- Calcium level less than 2,000 lb/A
- CEC less than 18 (for mineral soils only)
- % base saturation from calcium of less than 20%

Your Soil Conservation Service or Cooperative Extension System may be able to provide you with similar tables for soils in your area.



## Appendix 2

# FERTIGATION FOR BLUEBERRIES

Injection of fertilizers through drip irrigation systems allows growers to apply soluble fertilizers over the entire growing season in amounts adjusted for the seasonal needs of blueberries. Growers can use acid injections to adjust soil pH or overcome the negative effects of magnesium and calcium carbonates in irrigation water.

## Adjusting pH of the Irrigation Water

Efforts to reduce soil pH in blueberry plantings can be hindered by irrigation water with a high pH; concentrated sulfuric acid ( $H_2SO_4$ ) can be used to lower the pH to an acceptable level. To accurately adjust the pH of irrigation water, obtain a reliable pH meter, a source of sulfuric acid, and containers that accurately measure volume (a 2-gallon bucket and 2 measuring cups). Dilute the acid by pouring  $\frac{1}{2}$  cup acid into  $4\frac{1}{2}$  cups water (never pour water into acid). Pour  $\frac{1}{2}$  cup of this solution into another  $4\frac{1}{2}$  cups water. Repeat this step one more time. Discard the 9 extra cups of the acid solution. After three dilutions, the solution should be 1 part acid to 1,000 parts water.

Measure the pH of 1 gallon (16 cups) of irrigation water. Add one cup of the diluted acid solution, stir, and measure the pH of the irrigation water again. Continue to add 1 cup of diluted-acid solution until the pH is 5.0 or below, keeping track of the number of cups.

Use the following table to determine the number of ounces of concentrated sulfuric acid needed for every 1,000 gallons of irrigation water.

Cups of Diluted Acid	Ounces of $H_2SO_4$	Cups of Diluted Acid	Ounces of $H_2SO_4$
1	8	7	39
2	14	8	43
3	20	9	46
4	26	10	49
5	31	11	52
6	35	12	54

Next, determine the flow rate of the irrigation system. For example, many systems have pressure-compensating emitters with an output of 1 gallon per plant per hour (or  $\frac{1}{2}$  gallon every 2 feet). In a standard field (4- x 10-foot spacing), 1,100 gallons are emitted per hour of operation. To achieve the target amount of water per day (35 gal/100 ft of row), the system should run for  $1\frac{1}{2}$  hours (25 plants/100 feet of row x 1 gallon/plant x 1.5 hours = 37.5 gal/100 feet) to deliver 1,650 gallons to the acre. The amount of acid to inject over this period would be 1.65 times the amount in the second column above.

During the actual irrigation process, load the lines with water for the first 15 minutes, flush the lines during the last 15 minutes, and inject acid in the intervening time. In the previous example, actual injection time is 1 hour.

Although the pH of the irrigation water during injection will be less than 5.0 (because 1.5 hours' worth of acid is injected in just 1 hour), it will not damage the plants. Irrigation water with a pH as low as 2.0 will not hurt blueberries because the buffering capacity of soil rapidly raises it. A low pH also helps keep carbonates from building in the lines.

Injected chemicals also may acidify the irrigation water. One gallon concentrated sulfuric acid, 20.7 pounds ammonium sulfate, and 5 pounds sulfur have equivalent acidifying properties.

## ***Applying Fertilizers through Irrigation***

Precautions must be taken to prevent contamination of the water source when injecting chemicals into irrigation lines, especially when a municipal water source is used. Backflow preventers are commonly used to ensure that water moves in one direction. In the event of a pressure drop or siphoning effect at the source end, valves will close to prevent backwashing of the irrigation water. Minimum requirements usually consist of a backflow prevention device with two valves in tandem. Check with local regulations before chemical injection.

Chemicals to be injected should be highly soluble to prevent clogging of irrigation lines. Not all fertilizers are soluble. The following are acceptable for use in fertigation systems for blueberries.

Soluble Nutrients	Solubility <sup>1</sup> (lb/gal)	Equivalent Acidity <sup>2</sup> (lb. CaCO <sub>3</sub> per 100 lb)	Salt Index <sup>3</sup>
Urea	6.5	84	75
Ammonium sulfate	5.9	110	69
Monammonium phosphate <sup>4</sup>	1.9	58	25
Diammonium phosphate <sup>4</sup>	3.5	70	34
Phosphoric acid <sup>4</sup>	43.1	110	0
Potassium chloride	2.9	0	116
Magnesium sulfate	5.9	0	44
Zinc sulfate	8.0		
Zinc chelate <sup>5</sup>	–		
Boric acid <sup>6</sup>	0.5		
Solubor <sup>6</sup>	1.0		
Copper sulfate	2.6		
Copper chelate <sup>5</sup>	–		
Iron chelate <sup>5</sup>	–		

<sup>1</sup> Solubility, in pounds per gallon of water, varies with temperature. As water temperature increases, more fertilizer dissolves.

<sup>2</sup> Amount of calcium carbonate required to neutralize 100 lb of this chemical.

<sup>3</sup> Measure of saltiness of a chemical relative to sodium nitrate times 100.

<sup>4</sup> Phosphates should not be mixed with magnesium or calcium compounds.

<sup>5</sup> Chelates are highly soluble and are often available in liquid form.

<sup>6</sup> Extreme caution should be used when injecting boron. It is very difficult to obtain uniform application through a drip irrigation system, and excessive boron can be toxic to blueberries.

## KEY TO BLUEBERRY PROBLEMS

---

This section lists common symptoms exhibited by parts of a blueberry plant and possible causes. Most of the problems are discussed in the text; causes and control may be found on the pages given. For more information, contact Cooperative Extension in your area.

### Canes

---

- Weak Growth**
- Insufficient irrigation or a hardpan**—Persistent wilting of young leaves and stems; reduced leaf size. (pp. 10, 16, 18; ch. 12)
  - Scale**—Dull crusts on wood surface, honeydew with black, sooty mold. When scales are punctured, a yellow substance exudes from the crust. (pp. 71, 72)
  - Crown gall**—Tumors at base of canes and/or roots.
  - Rodents**—Presence of burrows and gnawed canes. (pp. 47, 50, 52)
  - Poor planting depth**—Plants set too deep or shallow. (p. 35)
  - Nematodes**—Knotty, poorly developed root system; reddish-brown lesions on roots. (p. 76)
  - Scarab beetles**—Root feeding by white grubs; skeletonized leaves. (pp. 62, 74)
  - Weevils**—Larvae damage to roots, leaves redden prematurely. (p. 73)
  - Restricted root growth**—Roots do not leave original potting mixture due to poor soil conditions. (p. 10)
  - Insufficient pruning**—Much brushy, twiggy growth; most canes more than 1 inch wide at base. (p. 37)
  - Stunt**—Greatly shortened internodes with downward-cupped, chlorotic leaves that are often spoon-shaped and have a yellowish margin. (p. 84)
  - Dogwood borer**—Burrows just under bark of stems, canes, or crowns. (p. 72)
  - Others**—Leaves discolored and/or distorted. (see Leaves, p. 175)
- Cane Dieback**
- Stem borer**—Tunnels in stems; tiny holes with frass. (p. 73)
  - Phomopsis canker**—Elongated, flattened areas near bases of canes. (p. 89)
  - Fusicoccum canker**—Reddish coloration at stem bud site, bull's-eye pattern on young canes. Cankers are 1 to 6 inches long and well defined. Pimple-like pycnidia on surface. (p. 87)
  - Phytophthora root rot**—Wilted branches and premature leaf drop; root vascular system black or reddish brown. (p. 90)

**Necrotic ringspot**—Shoot dieback and small, distorted leaves with faintly chlorotic areas that later turn brown and necrotic, leaving holes in leaves. (p. 82)

**Equipment damage**—Bark scraped or torn off cambium.

**Others**—All factors associated with weak growth. (see Canes, p. 174)

### **Branch or Tip Dieback**

**Stem blight**—Individual branch death, pecan-brown wood. Leaves or branches may be yellow or reddish during early stages of infection. (p. 91)

**Winter damage**—Browning of shoot tip with no bud break in spring. (p. 14)

**Frost damage**—Blackening of early leaves and/or floral buds. (p. 14)

**Potassium deficiency**—Dead shoot tips and scorched spots on leaves. (p. 100)

**Botrytis**—Blossom clusters turn brown and may fall off. Shoot tips and leaves become necrotic. Fungal spores on dead tissues are gray. (p. 86)

**Mummy berry**—Blighted shoots and sometimes flowers; masses of white spores, mummified berries that turn pinkish at ripening and fall off. (p. 88)

**Anthracnose**—Blighted shoot tips, no spore masses on leaves, fruit puckers at blossom end and develops salmon-colored spore masses. (p. 85)

**Wind damage**—Broken branches or canes.

**Boron deficiency**—Dead shoot tips and delayed bud break in spring. (p. 100)

**Tip borer**—Tiny hole near tip; yellow leaves with reddish veins. (p. 70)

### **Miscellaneous**

**Witches' broom**—Excessive lateral bud break. (p. 93)

**Stem gall wasp**—Pithy, kidney-shaped galls. (p. 70)

## **Leaves**

### **Chlorosis or Yellowing**

**Nitrogen deficiency**—Uniformly pale green leaves that eventually turn red, overall growth stunted. (p. 99)

**Manganese deficiency**—Broad band of interveinal chlorosis on young leaves, leaf margins become necrotic. (p. 100)

**Iron deficiency**—Narrow band of interveinal chlorosis on young leaves, no necrosis. (p. 100)

**Necrotic ringspot**—Chlorotic spots, rings or lines on all aged leaves, holes may drop out, overall vigor greatly reduced. (p. 82)

**Stunt**—Yellow tips and margins on leaves that turn bright red in later season, blades are cupped downward. (p. 84)

**Mosaic**—Yellow mottling on leaves that sometimes turns red. (p. 84)

**Simazine injury**—Interveinal chlorosis, straplike leaves with some mottling. (photo 142)

**Norflurazon injury**—Leaf veins turn white to pink. (photo 144)

**Glyphosate injury**—Surviving shoots produce small, narrow, chlorotic leaves. (photos 139–140)

### **Scorching or Brown Areas**

**Potassium deficiency**—Necrotic spots on young leaf blades and some interveinal chlorosis, reduced plant vigor. (p. 100)

**Spray damage**—Scorching of leaf margins and tips of young and old leaves; rapid onset of symptoms.

**Fertilizer burn**—Scorching of leaf margins and tips of predominantly young leaves.

**Paraquat injury**—Irregular coffee-brown spots on leaves.

**Anthracnose**—Irregular-shaped dead areas on leaves. (p. 85)

**Glyphosate injury**—Brownish black leaves that drop off, some tip dieback; surviving shoots produce small, narrow, chlorotic leaves. (photos 139–140)

**Terbacil injury**—Interveinal scorching with veinal chlorosis. (photo 143)

**Hexazinone injury**—Margins of leaves necrotic.

**Acute water shortage**—Browning of leaf margins, particularly on young shoots. Wilting of new growth. (pp. 16, 18; ch. 12)

**Frost damage**—Blackening of young leaves. (p. 15)

### **Overall Reddening of Leaves**

**Magnesium deficiency**—Older leaves turn bright red in Christmas-tree fashion. (p. 100)

**Transplant shock**—Whole plant turns a red or yellow color that disappears after establishment.

**Shoestring virus**—Red crescent-shaped leaves, red streaks on shoots. (p. 80)

**Red leaf**—Terminal leaves turn reddish in the middle of summer; undersides whitish due to development of fungal spores. Leaves eventually turn black and dry up.

**Stunt**—Bright red leaves in later season, blades are cupped downward; overall bush vigor reduced. (p. 84)

**Other**—Damage from girdlers, vine borers, weevils, and cranberry fruit-worms. (see *Canes*, p. 174)

### **Spots on Leaves**

**Double leaf spot**—Gray or light brown spots on leaves surrounded by dark brown ring, spots enlarge and become cinnamon brown.

**Septoria leaf spot**—Round, white spots on leaves with purple borders.

**Red ringspot**—Round red spots on upper leaf surface,  $\frac{1}{8}$  inch in diameter, beginning in late July and August. Ripe fruit may become spotted with round white spots. Stems may show  $\frac{1}{4}$ -inch circular red ringspot. (p. 83)

**Necrotic ringspot**—Chlorotic spots, rings, or lines on all aged leaves. Holes may drop out; overall vigor greatly reduced. (p. 83)

**Alternaria**—Small brown spots with red borders; spots may be round or irregular. (p. 85)

**Powdery mildew**—Surfaces of leaves covered with white mycelium, sometimes red-bordered chlorotic spots. Darkish groups of fungal fruiting bodies appear on underside of leaves. (p. 93)

**Miscellaneous** **Cold shock**—Purplish or yellowish cast on leaves that disappears in warm temperatures.

**Green fruitworms**—Feeding damage on leaves and flowers. (p. 62)

**Leafminers**—Mines on lower leaf surface, leaf tips tied to margins with silk. (p. 66)

**Aphids**—Small green or red sucking insect on young shoots and leaves, large quantities of honeydew. (p. 68)

**Leafrollers**—Leaves rolled in circular tunnels with larvae inside. (p. 64)

## **Flower Buds and Blossoms**

**Buds Develop** **Winter damage**—Whole shoot tip browned; no bud break in spring. (p. 14)

**Abnormally** **Frost damage**—Ovaries in floral buds blackened; blossoms do not open. (p. 15)

**Bud mites**—Feeding on bud tissues and scales; buds redden and do not expand. (p. 55)

**Spanworms**—Small brown holes in unopened blossoms; buds bored out. (p. 56)

**Winter moths**—Unopened brown buds; holes in side of bud with fine silken threads. (p. 57)

**Cranberry weevils**—Small brown holes in unopened blossoms; buds destroyed. (p. 57)

**Blighting** **Botrytis**—Blossom clusters turn brown or black; leaves become necrotic. (p. 86)

**Anthracnose**—Blossom clusters turn brown or black, berries shrivel and develop salmon-colored sporulation. (p. 85)

**Frost damage**—Blossom clusters turn brown or black; no leaf or fruit symptoms. (p. 15)

**Miscellaneous** **Bumblebees and carpenter bees**—Small holes found at base of corolla. (p. 64)

**Cutworms**—Missing buds or partially eaten buds. (p. 55)

**Green fruitworms**—Feeding damage on leaves and flowers. (p. 62)

## Fruit

---

**Wormy and Soft** **Maggots**—Soft and leaky berries with white maggots. (p. 60)

**Cranberry fruitworms**—Small green caterpillars that web several berries together, berries filled with frass. (p. 58)

**Shriveled** **Mummy berry**—Berries shrivel and turn a pinkish color, become mummified and fall off at ripening. (p. 88)

**Alternaria**—Blackish, dark-greenish sporulation on the blossom end of berry near harvest. (p. 85)

**Anthracnose**—Puckered blossom end of berry with salmon-colored sporulation. (p. 85)

**Cherry fruitworm**—Prematurely blue, shriveled berries containing black-headed larvae, entrance holes filled with silk. (p. 59)

**Plum curculio**—D-shaped puncture in green berries; prematurely blue, shriveled berries. (p. 61)

**Birds**—Pecked berries that remain attached. (p. 41)

**Undersized** **Poor pollination**—Very few seeds in fruit. (p. 142)

**Moisture deficiency**—Persistent wilting of young leaves and stems, reduced leaf size. (pp. 16, 18; ch. 12)

**Insufficient pruning**—Lots of twiggy, bushy growth on old, low-vigor canes. (p. 37)

**Overcropping**—Extremely high berry numbers per bush.

**Reduced plant vigor**—(see Canes, p. 174).

## TABLE OF CONVERSION FACTORS

---

	<i>English units</i>		<i>SI (metric) units</i>	<i>Multiply by</i>
<b>Length</b>	inches (in)	to	centimeters (cm)	2.54
	feet (ft)	to	meters (m)	0.30
	yards (yd)	to	meters	0.91
<b>Area</b>	ft <sup>2</sup>	to	m <sup>2</sup>	0.093
	acre (A)	to	hectare (ha)	0.40
<b>Weight</b>	ounces (oz)	to	grams (g)	28.4
	pounds (lb)	to	kilograms (kg)	0.45
	tons (t)	to	kilograms	907
<b>Volume</b>	pints (pt)	to	liters (l)	0.47
	quarts (qt)	to	liters	0.95
	gallons (gal)	to	liters	3.79
	acre-inch	to	liters	102,789
<b>Rate</b>	lb/A	to	kg/ha	1.12
<b>Speed</b>	miles/hour (mph)	to	km/h	1.6
<b>Pressure</b>	lb/in <sup>2</sup>	to	g/cm <sup>2</sup>	70.3
<b>Flow</b>	gal/min	to	l/min	3.79
	ft <sup>3</sup> /min	to	m <sup>3</sup> /min	0.028
	ft <sup>3</sup> /min	to	l/min	28.3
<b>Temperature</b>	degrees Fahrenheit (°F)	to	degrees Celsius (°C)	$\frac{5}{9} (°F - 32)$



## PHOTOGRAPHS

---



**Photo 1.**  
Lowbush blueberry planting in Maine.



**Photo 2.**  
Lowbush blueberry fruit.



**Photo 3.**  
Rabbiteye blueberry planting in winter.



**Photo 4.**  
Rabbiteye blueberry fruit.



**Photo 5.**  
Highbush blueberry planting.



**Photo 6.**  
Highbush blueberry fruit.



**Photo 7.**  
Rabbiteye (Bonita and Beckyblue) and highbush (Sharpblue) fruit.



**Photo 8.**  
Young half-high blueberry plant (Northblue).



**Photo 9.**  
Flower and vegetative bud break on a shoot.



**Photo 10.**  
Spring bud break in highbush blueberry.



**Photo 11.**  
Full bloom in a young planting.



**Photo 12.**  
New cane growth from crown in late spring.



**Photo 13.**  
Buds forming in axils of leaves in autumn.



**Photo 14.**  
Fibrous structure of a young root system.



**Photo 15.**  
Structure of a mature root system.



**Photo 16.**  
Flower clusters.



**Photo 17.**  
Cross section of a blueberry flower.



**Photo 18.**  
Bumblebee sonicating a flower.



**Photo 19.**  
Petal fall and fruit set.

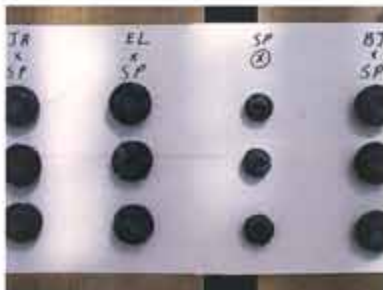

**Photo 20.**  
Effects of self-pollination (third row) and outcrossing on fruit size in Spartan.



**Photo 21.**  
Fruit cluster of ripening berries.





**Photo 22.**  
Winter-injured shoot.



**Photo 23.**  
Winter-injured flower.



**Photo 24.**  
Frost-injured blossoms.



**Photo 25.**  
Flooded blueberry plants.



**Photo 26.**  
Raised bed culture.



**Photo 27.**  
Stages of rooting in hardwood cuttings.



**Photo 28.**  
One-year-old plants rooted in lugs.



**Photo 29.**  
Container production of blueberry plants.



**Photo 30.**  
Screenhouse production.



**Photo 31.**  
Propagation beds.



**Photo 32.**  
Digging 2-year-old plants to sell.



**Photo 33.**  
Tissue-cultured plantlet.





**Photo 34.**  
Newly planted blueberry field.



**Photo 35.**  
Young field with sod middles and sawdust mulch.



**Photo 36.**  
Blueberry bush before pruning.



**Photo 37.**  
Blueberry bush after pruning.



**Photo 38.**  
Dead shoots remaining after cutting canes too high.



**Photo 39.**  
Bush after removing dead shoots.



**Photo 40.**  
Mature bush that has never been pruned.



**Photo 41.**  
Neglected planting.



**Photo 42.**  
Neglected planting after pruning.



**Photo 43.**  
Nectar robbing by honey bees.



**Photo 44.**  
Netting for bird control.



**Photo 45.**  
Auditory frightening device.



**Photo 46.**  
Explosive sound device.



**Photo 47.**  
Eye-spot balloon.



**Photo 48.**  
Hawk-kite.



**Photo 49.**  
Owl model.



**Photo 50.**  
Slanted deer fence.



**Photo 51.**  
Meadow vole.



**Photo 52.**  
Woodchuck.



**Photo 53.**  
Bud mite damage to fruit buds.



**Photo 54.**  
Cutworm.



**Photo 55.**  
Spanworm.



**Photo 56.**  
Adult blossom weevil.



**Photo 57.**  
Blossom weevil feeding injury.





**Photo 58.**  
Cranberry fruitworm adult.



**Photo 59.**  
Feeding site of cranberry fruitworm.



**Photo 60.**  
Cherry fruitworm eggs.



**Photo 61.**  
Adult blueberry maggot.



**Photo 62.**  
Maggot-infested berry.



**Photo 63.**  
Ovipositor entrance.



**Photo 64.**  
Plum curculio oviposition scar.



**Photo 65.**  
Green fruitworm.



**Photo 66.**  
Japanese beetle adult.



**Photo 67.**  
Rose chafer adult.



**Photo 68.**  
Carpenter bees (left) and bumblebees (right).



**Photo 69.**  
Leafroller nest in fruit.



**Photo 70.**  
Red-banded leafroller damage.



**Photo 71.**  
Oblique-banded leafroller larva.



**Photo 72.**  
Fruittree leafroller larva.



**Photo 73.**  
Adult red-banded leafroller.



**Photo 74.**  
Adult oblique-banded leafroller.



**Photo 75.**  
Adult fruittree leafroller.



**Photo 76.**  
Hatched egg mass of oblique-banded leafroller.



**Photo 77.**  
Fruittree leafroller egg mass.



**Photo 78.**  
Leafminer.



**Photo 79.**  
Leafminer tepee tent.



**Photo 80.**  
Sawfly larva.



**Photo 81.**  
Datana worms.





**Photo 82.**  
Sharp-nosed leafhopper egg scars and first instars.



**Photo 83.**  
Sharp-nosed leafhopper fifth instar.



**Photo 84.**  
Sharp-nosed leafhopper adult.



**Photo 85.**  
Blueberry aphids.



**Photo 86.**  
Tip borer injury symptoms.



**Photo 87.**  
Stem gall.



**Photo 88.**  
Putnam scale exposed on bark.



**Photo 89.**  
Putnam scale on fruit.



**Photo 90.**  
Terrapin scale.



**Photo 91.**  
Blueberry stem borer.



**Photo 92.**  
Adult root weevil.



**Photo 93.**  
Root weevil grub.





**Photo 94.**  
White grub.



**Photo 95.**  
Cuttings from an area infested with stubby-root nematodes (right) compared with cuttings from a clean area (left).



**Photo 96.**  
Necrotic flower clusters in Pemberton infected with blueberry scorch carlavirus.

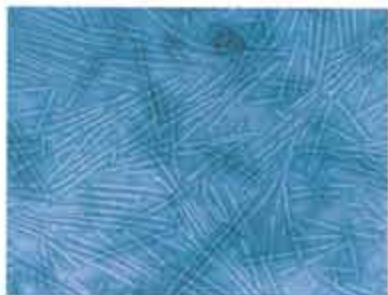

**Photo 97.**  
Rod-shaped virus particles purified from blueberry scorch-diseased blueberry.



**Photo 98.**  
A Berkeley bush infected with the blueberry shock ilarvirus.



**Photo 99.**  
A leaf from a Berkeley bush infected with the blueberry shock ilarvirus.

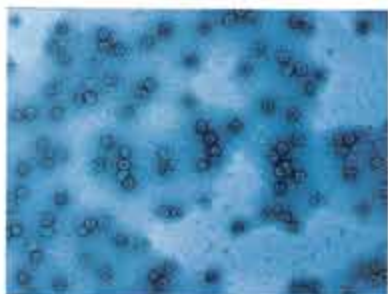

**Photo 100.**  
Spherical virus particles purified from blueberry infected with the blueberry shock ilarvirus.



**Photo 101.**  
Sheep Pen Hill disease at bloom.



**Photo 102.**  
Sheep Pen Hill disease during the first growth flush in plant on right.



**Photo 103.**  
Later stages of Sheep Pen Hill disease in plant on right.



**Photo 104.**  
Shoestring diseased leaves of Jersey.



**Photo 105.**  
Shoestring diseased leaves of Jersey, showing crescent-shaped leaves and reddening.





**Photo 106.**  
Shoestring diseased stem of Jersey showing elongate red streaks on wood.



**Photo 107.**  
Shoestring diseased blossoms of Jersey with characteristic pinkish coloration.



**Photo 108.**  
Leaves of Rubel infected with blueberry leaf mottle virus.



**Photo 109.**  
Leaves of Jersey infected with blueberry leaf mottle virus.



**Photo 110.**  
Necrotic ringspot in Pemberton exhibiting necrotic, shotholed and deformed leaves.



**Photo 111.**  
Necrotic ringspot in Concord with small, rosetted leaves.



**Photo 112.**  
Tomato ringspot virus–infected Earliblue leaves with mottles and spotting.



**Photo 113.**  
Fruit of Rancocas infected with red ringspot virus; small light spots on surface.



**Photo 114.**  
Leaves of Blueray infected with red ringspot virus. Spots may have green centers.



**Photo 115.**  
Stem of Blueray infected with red ringspot virus.



**Photo 116.**  
Leaves of Bluecrop infected with mosaic virus.



**Photo 117.**  
Leaves of Coville showing a mosaic pattern probably caused by a genetic disorder.





**Photo 118.**  
Blueberry stunt-diseased bush on right.



**Photo 119.**  
A stunt diseased Jersey bush showing downward-cupped leaves with yellowish borders.



**Photo 120.**  
Bluecrop leaves infected with stunt MLO.



**Photo 121.**  
Alternaria fruit rot.



**Photo 122.**  
Anthracnose fruit rot.



**Photo 123.**  
Botrytis blight of flower clusters.



**Photo 124.**  
Botrytis spores on blossoms.



**Photo 125.**  
Fusicoccum canker injury.



**Photo 126.**  
Stem symptoms of fusicoccum canker.



**Photo 127.**  
Mummy berry shoot infection.



**Photo 128.**  
Mummy berry spore formation on blighted shoots.



**Photo 129.**  
Mummy berry infection of fruit.



**Photo 130.**  
Interior of fruit infected with mummy berry.



**Photo 131.**  
Fruiting body of mummy berry fungus.



**Photo 132.**  
Phomopsis canker injury.



**Photo 133.**  
Stem symptoms of phomopsis canker.



**Photo 134.**  
Symptoms of stem canker.



**Photo 135.**  
Powdery mildew.



**Photo 136.**  
Witches' broom.



**Photo 137.**  
Rotary hoe for weed control.



**Photo 138.**  
Landscape fabric for weed control.



**Photo 139.**  
Severe injury from glyphosate herbicide.



**Photo 140.**  
Less severe injury from glyphosate.



**Photo 141.**  
Injury from napropamide herbicide.





**Photo 142.**  
Injury from simazine herbicide.



**Photo 143.**  
Injury from terbacil herbicide.



**Photo 144.**  
Injury from norflurazon herbicide.



**Photo 145.**  
Clean cultivation.



**Photo 146.**  
Grass middle and organic mulch.



**Photo 147.**  
Fescue row middle.



**Photo 148.**  
Nitrogen-deficient blueberry plant on right.



**Photo 149.**  
Phosphorus deficiency symptoms.



**Photo 150.**  
Potassium deficiency symptoms.



**Photo 151.**  
Leaves of magnesium-deficient blueberry plant.



**Photo 152.**  
Tip dieback caused by boron deficiency.



**Photo 153.**  
Range of boron levels in soil as they affect leaves.



**Photo 154.**  
Iron deficiency induced by high pH.



**Photo 155.**  
Blueberry roots fed different sources of nitrogen.



**Photo 156.**  
Sprinkler irrigation system in nursery.



**Photo 157.**  
Sprinkler system for frost protection.



**Photo 158.**  
Vertical boom sprayer.



**Photo 159.**  
Vertical boom sprayer.



**Photo 160.**  
Air mist sprayer.



**Photo 161.**  
Air-blast sprayer.



**Photo 162.**  
Hand-held harvester.





**Photo 163.**  
Tractor-powered harvester.



**Photo 164.**  
Self-propelled harvester.



**Photo 165.**  
Sorting line.



**Photo 166.**  
Flat of blueberries.



**Photo 167.**  
PYO blueberries.



**Photo 168.**  
PYO checkout building.

## GLOSSARY

---

- Abscission** The natural process of fruit or leaves detaching from the plant; occurs during ripening for fruit and in autumn for leaves.
- Air drainage** Movement of heavier, colder air to a lower elevation.
- Bearing** Plants or a portion of a plant producing fruit.
- Blight** Wilting and dying of a plant part from the tip toward the base.
- Bloom**
1. Flower or petal.
  2. Stage of development when the plant is flowering.
  3. The whitish, waxy material on the surface of a ripe berry.
- Blossom** Flower.
- Bud** An undeveloped shoot at the base of a leaf which will develop into a flower cluster or vegetative branch in spring. (figures 1–2)
- Bud swell** Enlargement of the buds in early spring, just before bud break.
- Bud break** The initial elongation of the shoot from the bud in spring.
- Calyx** The whorl of modified leaves below the flower petals that eventually develops into the cup on the end of the blueberry fruit.
- Cane** A woody shoot that grows from the base of the plant and extends into the upper canopy. (figure 1)
- Canker** An elongated or circular area on the cane that contains dying or dead tissue, caused by a pathogen.
- Chilling period** A requirement of resting or dormant buds for cold temperatures, usually measured as number of hours below 40°F.
- Chlorosis** A light-green or yellow coloration of plant parts that normally appear dark green.
- Clean cultivation** Regular cultivation or tillage between plant rows to remove all unwanted vegetation. (photo 145)
- Cluster** A group of flowers or berries on a shoot that develop from a single bud. (photo 16; cover photo)
- Conidia** Asexual spores formed on the hyphae of fungi.



- Cross-pollination* Fertilization of an egg with pollen from another plant.
- Crown* The underground base of the blueberry plant from which canes and roots arise. (figure 1)
- Desiccation* Drying out of a plant part that can cause deformity or tissue death.
- Dormancy* A period of inactivity in buds when active growth has temporarily ceased.
- Drift* Movement of a spray into an area where it was not intended to be applied.
- Economic threshold* The pest level at which control measures are economically justified.
- Endoparasites* Organisms that feed within the plant.
- Environmental conditions* Factors that affect plant growth, including temperature, humidity, rainfall, wind, and light.
- Equivalent acidity* A measure of the acidifying property of various chemicals measured in terms of the amount of calcium carbonate required to neutralize the chemical.
- Evaporative cooling* Application of water to plants during hot periods so the resulting evaporation will reduce plant temperature.
- Evapotranspiration* The combined loss of water from land area resulting from surface evaporation and plant transpiration.
- Fallow* To allow natural vegetation to grow in a field without a cultivated crop.
- Fence rows* Narrow areas surrounding cultivated fields that contain natural vegetation.
- Fertigation* Application of fertilizer through injection into drip irrigation systems.
- Frass* Very small plant parts and excrement that result from insect feeding.
- Habit* Type of growth or form exhibited by a plant.
- Hardening off* The active process of preparing for the cold temperatures of winter.
- Hardwood cutting* Propagation wood taken from dormant one-year-old shoots. (figure 5)
- Hybrids* Plants that result from crossing two individuals, usually different species or varieties, that are not closely related.
- Inoculum* Material containing pathogens that can infect healthy plant tissues.
- Necrotic tissue* Brown, dying, or dead plant tissue.
- Nutrient* A chemical element that is essential for proper plant growth and development.

- Organic* 1. Term used to describe a particular type of culture which excludes the use of synthetically manufactured chemical inputs.  
2. A type of chemical that consists of carbon atoms, usually in molecules containing hydrogen and/or oxygen.  
3. Any material derived from plant sources.
- Organic matter* Decomposing plant material in the soil that slowly releases nitrogen and organic acids.
- Outcrossing* Movement of pollen from one plant to another that is genetically different.
- Overcropping* Attempting to produce more fruit than a plant can sustain.
- Oviposition* Egg laying by a female insect.
- Pathogen* Any disease-causing organism.
- Petal fall* Stage of plant development after flowering and pollination when petals drop off the developing berry.
- Pigments* Chemicals in the plant that impart color.
- Postemergent* Active when weeds are growing vegetatively.
- Preemergent* Active before weeds are growing vegetatively.
- Ridging* Building a narrow hill the length of a row into which blueberries are planted.
- Roots* The underground structures of a plant that provide support and extract nutrients and water from the soil. (figure 1; photos 14–15)
- Salt index* A measure of saltiness of a particular chemical, expressed as the ratio of the increase in osmotic pressure of the chemical to that of an equivalent weight of sodium nitrate x 100.
- Scales* Small, thin, dry tissues surrounding the bud during dormancy.
- Scar* The point of attachment of the stem to the berry. When the fruit is ripe, tissue forms at this junction to prevent moisture loss.
- Scorching* A rapid reddening or browning of plant tissue that is normally dark green.
- Self-pollination* Fertilization of the egg with pollen from a genetically identical plant.
- Serological test* Test using antibodies extracted from the blood of vertebrates.
- Shock reaction* A strong, rapid response to a stimulus.

- Shoots* The aboveground portion of a plant consisting of the young growing branches or twigs with leaves. (figure 1)
- Softwood cutting* Propagation wood taken from actively growing shoots. (figure 6)
- Sonication* The act of vibrating a flower at a certain frequency so that pollen is released from the anthers.
- Terminals* The buds or leaves at the end of a growing shoot.
- Transpiration* The loss of water vapor through plant tissues, primarily through stomata in leaves.
- Twig* A small, short shoot or branch.
- Vector* An agent that transports a pathogen from an infected plant to a healthy plant.

## SUPPLEMENTAL INFORMATION

---

Some chapters include lists of resources specific to the topics covered: chapters 1 (p. 8), 3 (p. 21), 6 (p. 40), 7 (p. 54), 9 (p. 94), 10 (p. 98), 12 (p. 127), and 14 (p. 148).

Antonelli, A. L., C. H. Shanks, and G. C. Fisher. *Small Fruit Pests: Biology, Diagnosis, and Management*. EB 1388. Washington State University Cooperative Extension, 1988. 20 pages.

Baker, M. L., and K. Patten (eds.) *Texas Blueberry Handbook*. 1988. 220 pages. Extension Horticulture, Texas A & M Research and Extension Center, P.O. Box 38, Overton, TX 75684

Doughty, C. C., et al. *Highbush Blueberry Production*. PNW 215, Washington, Oregon, Idaho. 1981. 25 pages. Bulletin Office, Cooperative Extension, Cooper Publications Building, Washington State University. Pullman, WA 99164-5912.

Fisher, G., et al. *PNW Insect Control Handbook*. 1991. Oregon State University Cooperative Extension, Corvallis, OR 97331.

Gough, R. E. *Highbush Blueberry Management*. In press. Binghamton, New York: Haworth Press.

Gough, R., et al. *Highbush Blueberry Culture*. NE 248. 1983. 35 pages. Publication Office-C, Room 10, Woodward Hall, University of Rhode Island, Kingston, RI 02881-0804.

Goulart, B., et al. *Small Fruit Production and Pest Management Guide*. 1991. 111 pages. Publications Distribution Center, 112 Agricultural Administration Building, The Pennsylvania State University, University Park, PA 16802.

Fugua, B., et al. *Growing Blueberries in Missouri*. Bulletin No. 42. 1987. 26 pages. State Fruit Experiment Station of SMSU, Mountain Grove, MO, 65711.

Hanson, E., and J. Hancock. *Hints on Growing Blueberries*. Extension Bulletin E-2066. 1988. 8 pages. Bulletin Office, 10B Agriculture Hall, Michigan State University, East Lansing, MI 48824-1039.

*Highbush Blueberry Varieties for Michigan*. E-1456. 1980. 4 pages. Bulletin Office, 10B Agriculture Hall, Michigan State University, East Lansing, MI 48824-1039.

Hoover, E., et al. *Blueberry Production in Minnesota*. AG-FO-2241. 1988. 10 pages. University of Minnesota, Distribution Center, 3 Coffey Hall, 1420 Eckles Ave., Saint Paul, MN 55108-1030.

- Horton, D., et al. (eds.) *Small Fruit Pest Management and Culture*. 1989. 116 pages. Agricultural Business Office, Room 215, Conner Hall, University of Georgia, Athens, GA 30602.
- Koepsell, P. A., et al. *PNW Plant Disease Control Handbook*. 1991. Oregon State University Cooperative Extension, Corvallis, OR 97331.
- Krewer, G., and S. Myers. *Commercial Blueberry Culture*. Circular 713. 1989. 16 pages. Extension Publication Office, Hoke Smith Building, The University of Georgia, Athens, GA 30602.
- Lyrene, P. M., and T.E. Crocker. *Commercial Blueberry Production in Florida*. 1991. 12 pages. University of Florida Publications, IFAS, Building 664, Univ. of Florida, Gainesville, FL 32611.
- Mainland, C. M. *Commercial Blueberry Production Guide for North Carolina*. 1979. 30 pages. Publication Office, Box 7603, North Carolina State University, Raleigh, NC 27695-7603.
- Milholland, R. D., and J. R. Meyer. *Diseases and Arthropod Pests of Blueberries*. Bulletin 468. 1984. 33 pages. Publications Office, Box 7603, North Carolina State University, Raleigh, NC 27695-7603.
- Pruning Blueberries*. 1989. Michigan State University. CES Videotape VT19.
- Puls, E., Jr. *Commercial Blueberry Production*. Pub. 2363. 1989. 35 pages. Publications Office, Room 128 Knapp Hall, Louisiana State University, Baton Rouge, LA 70803.
- Ramsdell, D. *Blueberry Diseases in Michigan*. E-1731. 1983. 7 pages. Bulletin Office, 10B Agriculture Hall, Michigan State University, East Lansing, MI 48824-1039.
- Ridley, J. D. *Blueberry Production Guide for South Carolina*. Circular 594. 1987. 14 pages. Bulletin Room, P & AS building, Clemson, SC 29634-5609.
- Rutledge, A. *Blueberries*. Pub. 602. 1987. 6 pages. Director of Services, Institute of Agriculture, University of Tennessee, P.O. Box 1071, Knoxville, TN 37901-1071.
- Shaller, C. *Growing Blueberries*. EL600. 4 pages. 316 Plant Science Building, University of Arkansas, Fayetteville, AR 72701.
- Strang, J., et al. *Growing Highbush Blueberries in Kentucky*. H0-60. 1989. 8 pages. Agriculture Distribution Center, University of Kentucky, Lexington, KY 40546-02291.
- Strik, B., and J. Hart. *Blueberry Fertilizer Guide for Oregon*. FG 23. 1991. Oregon State University Cooperative Extension, Corvallis, OR 97331.
- Strik, B., L. Ketchum, R. Penhallegon, and D. Brazelton. *Pruning Highbush Blueberries. A Grower's Guide*. VTP 002. 1990. 21 minutes. Oregon State University Cooperative Extension, Corvallis, OR 97331.