

---

---

# **Livestock Pest Management:**

*A Training Manual for  
Commercial Pesticide Applicators  
(Category 1D)*

Edward D. Walker  
Julie A. Stachecki

---

---

## Preface

This manual is intended to prepare pesticide applicators in category 1D, livestock pest management, for certification under the Act 451, Natural Resources and Environmental Protection Act, Part 83, Pesticide Control, Sections 8301 to 8336. Read the introduction to this manual to understand your responsibilities for obtaining the appropriate credentials to apply pesticides and how to use this manual.

## Acknowledgements

This manual, "Livestock Pest Management: A Training Manual for Commercial Pesticide Applicators (Category 1D)," was produced by Michigan State University, Pesticide Education Program in conjunction with the Michigan Department of Agriculture. The following people are recognized for their reviews, suggestions and contributions to this manual:

George Atkeson, Ionia county agriculture agent, Michigan State University Extension, Ionia, MI

Linda S. Mansfield, VMD, PhD, Microbiologist, laboratory chief, Animal Health Diagnostic Laboratory, College of Veterinary Medicine, Michigan State University, East Lansing, MI

Larry G. Olsen, PhD, pesticide education coordinator, Michigan State University Extension, East Lansing, MI

Pamela L. Ruegg, DVM, MPVM, Dip. ACVPM, ABVP-Dairy, previously Project Leader-Veterinary Extension, Michigan State University Extension, East Lansing, MI

Barbara Straw, VMD, PhD, Ellis Swine Professor, Department of Large Animal Clinical Sciences, Michigan State University, East Lansing, MI

Paul Wylie, Allegan county agriculture and natural resource agent, Michigan State University Extension, Allegan, MI

Materials from several sources were used to compile this information with input from North Carolina Extension, Key to Insect and Mites; Fly Control in Confined Livestock and Poultry Production, Ciba-Geigy Agricultural Division, Greensboro, NC; Managing Insect Problems on Beef Cattle, Kansas State University, Manhattan, KS; Poultry Pest Management for Pennsylvania and the Northeast, The Pennsylvania State University, Extension Service, College of Agriculture, University Park, PA; Pest Management Principles for the Commercial Applicator: Animal Pest Control, University of Wisconsin Extension, Madison, WI; and External Parasites of Poultry, Purdue University Extension, West Lafayette, IN, photographs from Harlan Ritchie, Michigan State University, East Lansing, MI, Ned Walker, Michigan State University, East Lansing, MI, Vocational Education Publications, California Polytechnic State University San Luis Obispo, CA, Ralph Clewenger, Santa Rosa, CA, and Lepp and Associates, Los Osos, CA.

---

# TABLE OF CONTENTS

<b>Preface</b> .....	2
<b>Acknowledgements</b> .....	2
<b>Introduction</b> .....	5
<b>Chapter 1: Pests and Integrated Pest Management (IPM)</b>	
Insects.....	8
Mites and Ticks.....	10
Damage Caused by Insects and Insect-like Pests .....	10
Integrated Pest Management for Animal Health .....	12
Key to Insects and Mites of Medical and Veterinary Importance .....	19
<b>Chapter 2: Pesticides and Their Use For Livestock Pest Management</b>	
Pesticides .....	33
Classes of Insecticides/Acaricides Used in Livestock Pest Management .....	34
Formulations Used in Managing Animal Pests.....	36
Methods of Application and Application Equipment.....	37
Pesticide Use Around Animals .....	41
Compatibility of Pesticides.....	42
<b>Chapter 3: Mites and Ticks</b>	
Mites.....	45
Management of Mites on Animals or in Animal Environments.....	52
Ticks.....	54
Detecting and Identifying Ticks.....	55
Important Ticks Affecting Animal Health.....	56
Management of Ticks on Animals .....	57
<b>Chapter 4: Chewing and Sucking Lice</b>	
Chewing and Sucking Lice Comparisons.....	60
Life Cycle of Lice .....	62
Effects of Lice on Animal Health .....	62
Managing Lice on Cattle and Other Livestock .....	65
<b>Chapter 5: Fleas</b>	
Flea Life Cycle.....	67
Dog and Cat Fleas: Life History .....	68
Flea Management .....	69
<b>Chapter 6: Flies</b>	
Biting, Blood-feeding Flies.....	72
Management of Blood-feeding Flies.....	74
Nuisance Flies.....	75
Management of Filth Flies .....	78
Bot Flies.....	79

**Chapter 7: Host Animals and Their Pests**

Dairy Cattle ..... 83  
Confined Cattle..... 85  
Range and Pasture Cattle..... 86  
Swine..... 86  
Sheep and Goats..... 87  
Horses ..... 88  
Poultry ..... 90

**Answer Key for Review Questions**..... 92

**Glossary**..... 95

**Appendix A: Convenient Conversion Factors**..... 111

**Appendix B: Michigan State University Extension Directory** ..... 115

**Appendix C: Michigan Department of Agriculture Directory** ..... 117

**Michigan Department of Environmental Quality–Environmental Response Division** ..... 118

**Michigan Groundwater and Fresh Water Protection Act:  
    Sources of information and assistance** ..... 119

**Pesticide Emergency Information**..... 121

---

# INTRODUCTION

This manual presents basic pest, pest management and pesticide handling information for persons who apply pesticides on animals or in places where animals are kept – livestock pest management, category 1D. For purposes of this manual, “livestock” includes poultry when used in general terms.

Pesticides are used by many people for many different purposes. Pesticides protect humans, food and non-food crops, homes, pets, livestock and keep various industrial processes pest-free and functioning efficiently. To better protect the environment and human health by assuring the safe use and application of pesticides, the Michigan Department of Agriculture (MDA) administers the certification and registration program for pesticide applicators. Certification or registration requires obtaining the necessary knowledge to purchase and safely use pesticides.

There are numerous types of businesses, activities and individuals that are subject to certification or registered technician status. The following is a list of pest control categories defined in Regulation 636, part of Act 451, Part 83, Pesticide Control:

- (1A) Field Crops
- (1B) Vegetable Crops
- (1C) Fruit Crops
- (1D) Animal
- (2) Forest
- (2A) Wood Preservation
- (3A) Turfgrass
- (3B) Ornamental (Exterior trees, shrubs and ground covers)
- (4) Seed Treatment
- (5) Aquatic (Lakes, ponds, streams, etc.)
- (5A) Swimming Pools
- (5B) Microbial (Cooling towers, air washers, etc.)
- (6) Right-of-Way
- (7A) General Pest Management (Pests in, on or around human dwellings, institutions, food handling establishments, etc.)
- (7B) Wood Destroying Organisms
- (7C) Contractual Public Health
- (7D) Vertebrate
- (7E) Interiorscape
- (7F) Mosquito Management

- (7G) Pest Management for Small Animals (companion animals)
- (8) Public Health
- (9) Regulatory
- (10) Demonstration and Research

This manual presents basic pest, pest management and pesticide handling information for persons who apply pesticides on animals or in places where animals are confined; Livestock Pest Management, category (1D). This manual is not intended to provide all the information necessary for effective pest control with the use of pesticides labeled for use on or around animals. Pesticide applicators are expected to obtain up-to-date information about recommended materials and methods from labels, manufacturers, reference manuals, Extension personnel, veterinarians and professional associations. The label carries important information about proper dilution rates, timing, placement and precautions when using pesticides for animal health reasons. Be sure to follow all directions on pesticide labels. The label is the law.

## Suggestions for Studying This Manual

This manual, divided into seven chapters, is designed to assist commercial applicators meet pesticide certification requirements. You may already know some of the material from your experience with pesticides. There are learning objectives at the beginning of each chapter to help you identify what you should be able to accomplish after reading the information. Self-help questions are included at the end of each chapter. These questions are to help you study and are not necessarily the questions on the certification examination. If you have problems using the manual, please consult your county extension agent, your supervisor or a representative of the MDA for help.

## Some suggestions for studying the manual are:

1. Find a place and time for study where you will not be disturbed.
2. Read the entire manual once to understand the scope and the manner in which the material is presented. A glossary at the back of the manual defines some of the terms used in the chapters.

3. Study one chapter of the manual at a time. Review the learning objectives for each chapter. These will help you identify important points in the text. Consider underlining important points in the manual or take written notes as you study the chapter.

4. Answer, in writing, the self-help questions at the end of each chapter. These questions are intended to help you study and evaluate your knowledge of the subject. They are an important part of your study.

5. Reread the entire manual once again when you have finished studying all of its sections. Review with care any sections that you feel you do not fully understand.

This manual is intended to help you use pesticides effectively and safely when they are needed. We hope that you file it in a convenient place and review it occasionally to keep the material fresh in your mind.

---

## CHAPTER 1

# PESTS AND INTEGRATED PEST MANAGEMENT (IPM)

### LEARNING OBJECTIVES:

After you finish studying this chapter, you should be able to:

- Explain the importance of correctly identifying pests.
- Explain the importance of understanding the life cycles and habits of pests.
- Name two physical characteristics that all insects have in common.
- List the four primary types of insect mouthparts and give an example of an insect that has each type.
- Define “metamorphosis”.
- List other types of pests that resemble insects or cause similar damage.
- Understand how endoparasites and ectoparasites are pests of animals.
- Explain the factors you should consider when deciding whether control of a pest is necessary.
- Discuss the five steps of an integrated pest management program.
- List and give an example of techniques used in pest management.

---

Livestock management – the domestication and confinement of animals (and birds) – tends to increase insect and mite pest problems. For both humane and economic considerations, it is the animal manager’s challenge to avoid and counteract these problems.

Good management must be based on accurate information, including a thorough understanding of many interrelated items. The total livestock (including poultry) management system must provide for the following:

- Financing.
- Source of quality livestock.
- Shelter and spatial arrangement.
- Nutrition.
- Health care.
- Personnel.
- Schedules.

This means, personnel and equipment must be provided to accomplish the following activities:

- Purchasing and marketing.
- Breeding and genetic management.
- Livestock handling (cages, pens, gates, fences, scales, squeeze chutes, loading chutes, alleyways, barns, etc.).

- Pasture and range management.
- Feed storage and handling.
- Water supply.
- Veterinary care and pest management.
- Pesticide storage, application and cleanup.
- Recordkeeping on most of the above.

Many of the items listed above have implications for pest management. For example, the purchase of infested animals, overcrowding, poor nutrition and inadequate manure handling all contribute to serious insect and mite problems. Sloppy feed handling and overfilled watering facilities create fly-breeding environments. Poorly trained or insufficient personnel may not detect problems or make inappropriate or ill-timed attempts to solve them.

Successful pest management is the result of avoiding or reducing opportunities for pests through overall management, combined with sanitation practices and wise pesticide use aimed at maintaining pest populations below economic injury levels.

Accurately identifying pests is extremely important because different pests respond to different types of management tactics. Failure to identify the pest properly may result in wasted time, money, chemicals and effort.

Each species of plant and animal can be identified by its scientific name. Although most plants and animals also have common names, the scientific naming system is universal — it assigns each organism one name to be used regardless of where it is found. This naming system categorizes animals based on their similarities: organisms with common characteristics are placed into large groups, then subdivided into smaller groups and finally given unique names.

In this chapter, you will learn to identify common characteristics of insect and insect-like pests of small animals. Examples of the types of animal injury caused by these pests are discussed.

## INSECTS

All insects and related animals, such as mites and ticks, belong to a large group (phylum) called Arthropoda. Members of this group are called arthropods and have segmented bodies; segmented appendages, some of which are modified for feeding; and a hard exoskeleton (exterior skeleton). On the basis of common characteristics, arthropods are separated into smaller groups called classes. The common classes of arthropods are Insecta, Arachnida, Crustacea, Chilopoda and Diplopoda. Most arthropod pests are insects or arachnids (mites or ticks from the class Arachnida).

Insects have unique external features and undergo developmental processes unlike those of other organisms in the animal kingdom. Correct identification of pests and a knowledge of their characteristics, development and behavior are keys to effective pest control.

### Physical Characteristics of Insects

These external characteristics set them apart from other animals. Adult insects have bodies with three regions — head, thorax, and abdomen — and three pairs of jointed legs.

**1. Head.** The head contains one pair of antennae, eyes and mouthparts. Antennae contain many sensory receptors for smell, wind and temperature. The four general types of mouthparts are chewing, piercing-sucking, sponging and siphoning.

**Chewing mouthparts** have toothed jaws that bite and tear food. Cockroaches, grasshoppers, ants and beetles have chewing mouthparts.

**Piercing-sucking mouthparts** consist of a long, slender tube that penetrates plant or animal tissue to suck out fluids. True bugs, aphids, mosquitoes and sucking lice have this mouth type.

**Sponging mouthparts** are tubular, tongue-like structures with a spongy tip to suck up liquids. This type of mouthpart is found on flies.

**Siphoning mouthparts** form a long tube for sucking nectar. Butterflies and moths have this type of mouth.

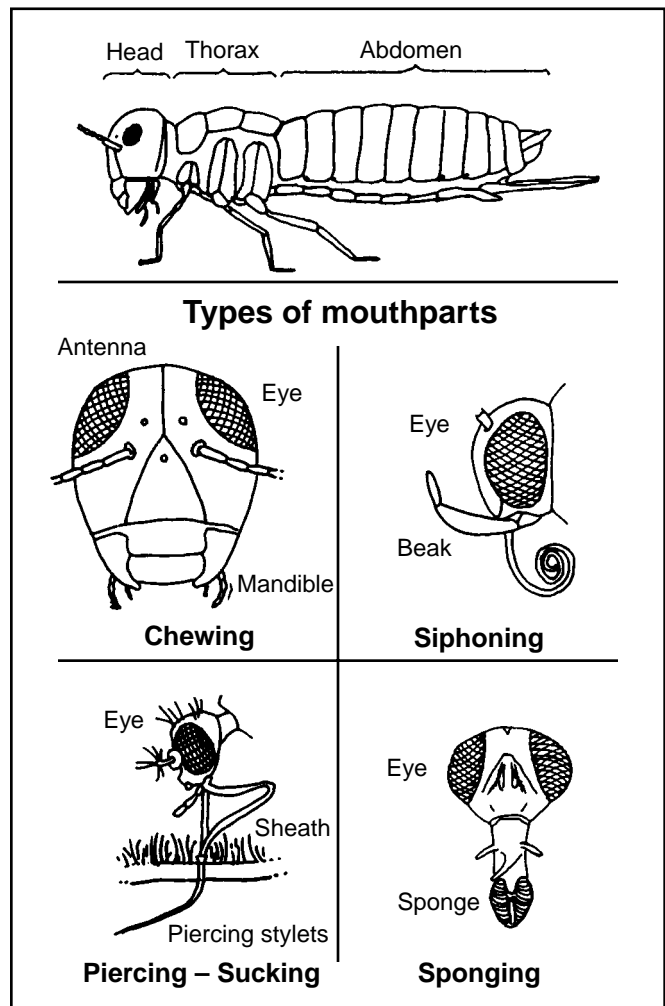

**2. Thorax.** The thorax consists of three segments with one pair of jointed legs per segment. If one pair of wings is present, they will be on the second segment. If two pairs of wings are present, they will be on segments two and three and are called forewings and hindwings. The forewings are modified in some insect groups. Beetles have shell-like forewings; grasshoppers have leathery forewings. Forewings of true bugs are part membranous, while forewings of moths and butterflies are membranous but covered with scales. Most hindwings of insects are membranous.



**3. Abdomen.** The abdomen has as many as 11 segments, though 8 or fewer visible segments are common.

## Insect Development and Metamorphosis

The series of events from egg to adult is called the insect's **life cycle**. Life cycles vary among species, and knowledge of the life cycle is absolutely essential to apply correct and timely pest management procedures.

Most insect reproduction is sexual — that is, a female's egg cell develops only after union with the male's sperm cell. The females of many insect species lay eggs. Some insects have special modes of reproduction such as those that develop from unfertilized eggs. The number of eggs produced by females varies from one egg to many thousands for some social insects.

A newly hatched insect differs in size and often in form from the parents. The change that takes

place before the young insect assumes the adult form is called **metamorphosis**. The degree of change varies widely. In some insects, it is slight and gradual; in others, it is abrupt and complete.

Insects fall into three groups according to degree of metamorphosis:

- **No metamorphosis.** Body proportions and internal organs of these primitive insects remain similar after each molt. Examples: Collembola (springtails) and Thysanura (silverfish).
- **Gradual metamorphosis.** Changes are slight and gradual. The young or nymphs resemble the adults and feed in the same habitat, and wing development is external. Example: grasshoppers.
- **Complete metamorphosis.** Drastic alterations occur as insects grow through the egg, larval, pupal (an inactive, resting stage) and adult stages. This classification includes the majority of insects, such as flies and fleas.

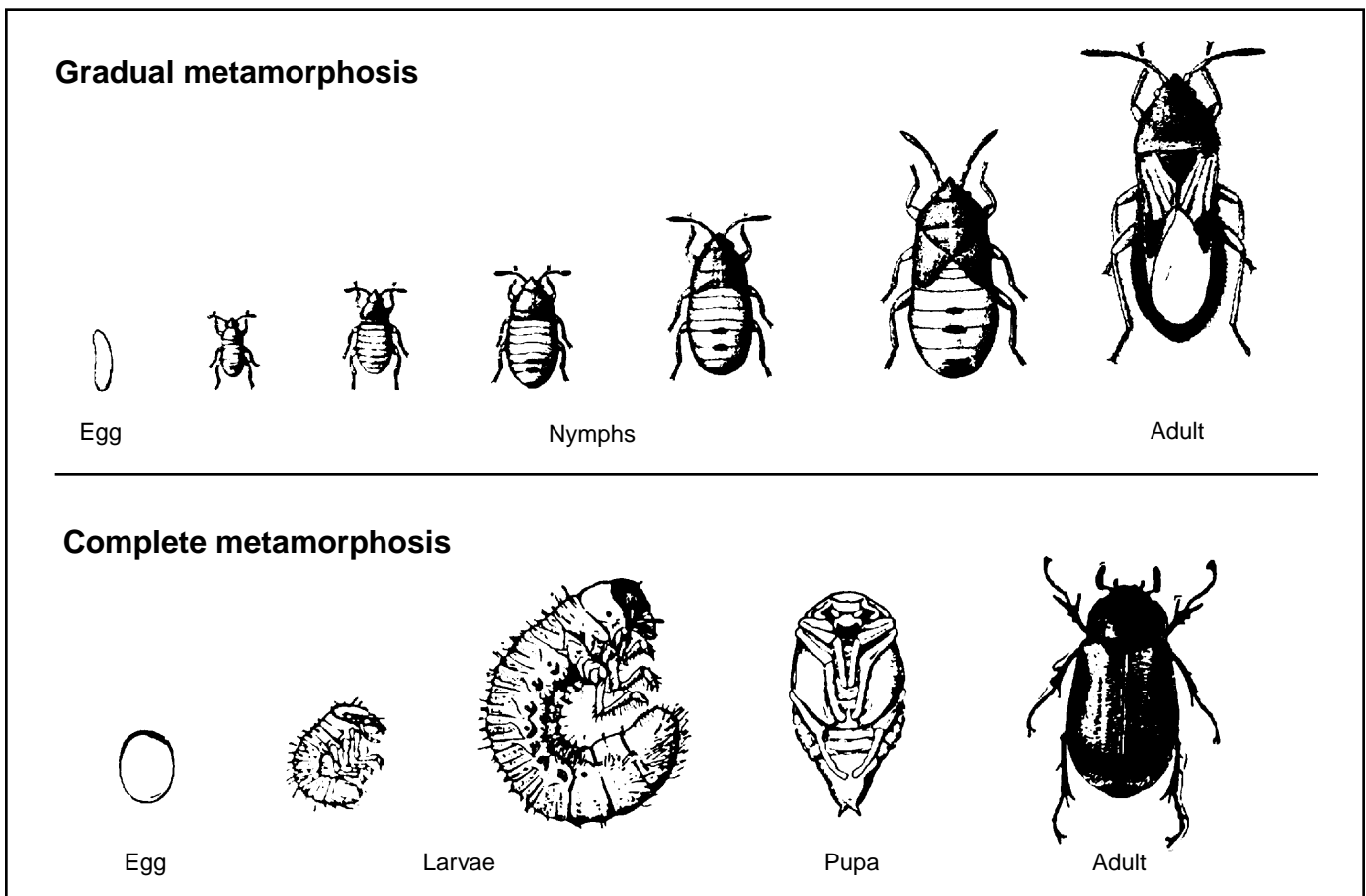

## MITES AND TICKS

Mites and ticks belong to the class Arachnida. Though they are relatives of spiders, scorpions and daddy longlegs, mites and ticks belong to their own scientific grouping within this class, called the Acari (a-CAR-ee). Two features distinguish mites and ticks from insects. Mites and ticks have:

1. **Four pairs of legs** (insects have three pairs).
2. **Two major body units**—the cephalothorax and abdomen (insects have three body units — head, thorax and abdomen).

Unlike insects, ticks and mites do not have segmented abdomens.

### Mite Development

The generalized mite life cycle begins when mites mate and the females lay eggs. The eggs hatch and six-legged larvae emerge. These larvae feed and molt to become eight-legged nymphs. Later, after feeding, the nymphs molt and become adult male or female mites. This entire life cycle can take as little as eight days to as long as four weeks, depending on the species of mite and the temperature and humidity.

### Tick Development

Tick development starts with the egg stage, followed by six-legged larvae, eight-legged nymphs and eight-legged adults. Hard ticks have only one nymphal instar (that is, one molt to the nymph stage, followed by a molt to the adult stage).<sup>Tick</sup> Soft ticks may go through up to seven nymphal molts, depending on the species of tick and its life cycle.

## DAMAGE CAUSED BY INSECTS AND INSECT-LIKE PESTS

Insects, ticks and mites injure animals, plants and structures in a variety of ways. The damage or discomfort of the host often provides clues to the identity of the pest, as well as the fate of the host (the organism affected by the insect). For example, hair loss (**alopecia**) under the eyes

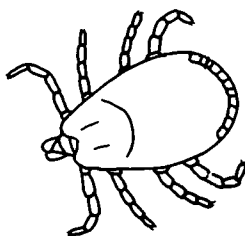

Tick

and near or on the ears of young animals may be the first recognizable symptoms of demodectic mange mites. Consult with a veterinarian for correct diagnosis — sampling for burrowing mites requires a skin scraping. Scratching may be symptoms of fleas or ticks, and head shaking may indicate the presence of ear mites.

Animals can be troubled with pests on their bodies, in their bodies or in their environment. Many arthropods (spiders, mites and ticks) have evolved to live in close association with animals, and some have become true pests of animals. Arthropods may use animals as hosts for food, hosts to lay their eggs in or on, sites for resting and for other uses.

Arthropods may be ecto- or endoparasites. **Ectoparasites** live on the outside of the body of the host (animal the pest is associated with) more or less in permanent association. All the many species of fleas are examples of ectoparasites found on bodies of wild or domestic animals. Even human beings can have ectoparasites such as head lice, follicle mites and crab lice.

Arthropod pests that invade internal parts of the body are called endoparasites. Most endoparasite infestations should be referred to veterinarians for treatment.

Arthropods can be pests of animals in several ways:

- They may **invade** and **infest** the skin and tissues of animals, causing direct damage such as hot spots (moist eczema) and physical weakness.
- Arthropods can cause **blood loss** and tissue damage by **blood feeding**.
- Infestation and blood feeding can open the skin to **secondary infection** by bacteria.
- Blood-feeding can also cause **anemia** (weakness, lack of vitality due to blood loss or iron deficiency).
- Some arthropods have **venomous bites and stings** or have body secretions that cause the animal to have **toxic** or **allergic reactions**.

The direct damage and inflammatory reaction of animal skin to arthropod bites or body secretions is called **dermatitis**. Some animals develop extreme allergies to insect bites, stings or secretions. This kind of allergic reaction is called **hypersensitivity**. Veterinarians should be consulted to diagnose the cause of dermatitis. Once the cause is identified, the licensed veterinary technician, animal groomer, kennel manager or other trained animal pesticide applicator can be involved in treating the animal and controlling the problem.

Animals can be greatly annoyed by the presence and activity of certain arthropods. For example, cattle will bunch up and put their lowered heads together to seek relief when “fly strike” is severe.

Many arthropods transmit disease-causing agents to animals, either by contact, body secretions or biting. For example, mosquitoes transmit viruses that cause encephalitis (inflammation of the brain) in horses, and ticks can transmit Lyme disease among animals and humans.

The arthropod pests of animals fit into many groups or taxonomic categories. Table 1.1 lists these groups and gives both common and scientific names with an example of each group. The following chapters discuss in detail how each of these groups affect agricultural animals, as well as how to detect, identify and manage the arthropod pests.

Among these arthropods are **arachnids** (the class Arachnida), including mites, ticks and poisonous spiders. Spiders will not be considered

further in this manual because they are not normally pests of domesticated animals.

Among the **insects** (the class Insecta), the important pests of animals belong in the following groups:

- Biting and non-biting flies.
- Invasive flies (flies whose maggots invade and infest animal flesh).
- Chewing and sucking lice.
- Fleas.

Stinging wasps and ants sometimes bother animals but will not be discussed in this manual.

The “key” at the end of this chapter, is an illustrated guide to identifying arthropods of medical and veterinary importance. To use the key, read the choices given by each number and select the choice that best describes the arthropod specimen you are trying to identify. Some knowledge of the body structure and life cycles of insects, ticks and mites is required to use this identification key. So,

**Table 1.1 Major groups of arthropods affecting animal health.**

Group	Scientific Name	Example
<b>Class Arachnida</b>		
Mites	Order Acari	Scabies or itch mite ( <i>Sarcoptes scabiei</i> )
Ticks	Order Acari	American dog tick ( <i>Dermacentor variabilis</i> )
<b>Class Insecta</b>		
Biting flies	Order Diptera	Stable fly, dog fly ( <i>Stomoxys calcitrans</i> ), mosquito, black fly, horse fly, deer fly, horn fly, biting midges, sheep ked
Nonbiting flies	Order Diptera	House fly ( <i>Musca domestica</i> ), face fly, eye gnats, other filth flies (flies associated with unsanitary conditions)
Invasive flies (causing myiasis)	Order Diptera	Northern cattle grub ( <i>Hypoderma bovis</i> )
Sucking lice	Order Anoplura	Hog louse ( <i>Haematopinus suis</i> )
Chewing lice	Order Mallophaga	Cattle biting louse ( <i>Bovicola bovis</i> )
Fleas	Order Siphonaptera	Cat flea ( <i>Ctenocephalides felis</i> )

it is an educational tool as well as an identification guide. Give it a try! You will **not be required** to use the key to answer questions on the Michigan Department of Agriculture pesticide certification exam. You will need to be able to identify the general appearance of arthropod pests of animals by looking at a drawing similar to those found in later chapters, i.e., the difference between a mite and a flea.

## INTEGRATED PEST MANAGEMENT FOR ANIMAL HEALTH

**Agricultural animals** (those used for production of food and fiber—livestock) and **companion animals** (pets such as dogs and cats) may be affected by arthropod pests. These pests often must be managed, controlled or prevented to improve the living conditions, health and well-being of animals and humans. The principles of **integrated pest management (IPM)** apply to the operational practice of pest control for animals, whether the pests are actually on the animals or in the environment the animals occupy. IPM can be defined as “the use of all appropriate and economical strategies to manage pests and their damage at acceptable levels with the least disruption to the environment.”

Establishing an IPM program for pests of animals follows the same five steps outlined for managing any pest (weeds, diseases, etc.).

### 1. Detection

The first step in an IPM program is pest **detection**. Detection requires thorough and regular monitoring of animals for pest infestations or other signs and symptoms that indicate a pest is present on the animal or in the environment where animals live. Observing an animal’s body, feces, living quarters, bedding, surroundings and

behavior will help you discover potential pest problems. For example, if an animal is scratching or chewing more than usual, this behavior may cause the owner to suspect fleas and, therefore, to search for fleas on the animal. More severe conditions require a veterinarian’s diagnosis of the health condition. The problem may be inhalant allergies or a secondary bacterial infection that should be treated only by a licensed veterinarian.

Animal health management requires frequent and routine monitoring. Frequent observations allow for early pest detection. Early detection of small pest populations may allow for more control options. Some control measures may work on limited numbers of pests but not on larger populations. Early pest detection also reduces or prevents the discomfort that would be caused by the pest if its population were to increase. Never attempt a diagnosis that should be made by a veterinarian. Always consult a veterinarian if you don’t find or cannot identify the pest problem.



Inspect animals regularly for pest infestations.

Persons who handle animals should be trained in correct handling and restraining techniques to avoid injury to the handler and the animal. Animals are often apprehensive when confined or at



Two types of traps used for monitoring fly populations in the animals’ environment.

veterinary clinics and should be handled with extreme caution. Animal aggression may become obvious in strange surroundings or the animal may react unpredictably out of fear. Correct use of restraining holds and devices may benefit both the animal and the handler. Inspecting an animal for pests may be accomplished effectively with two persons—one handler-restrainer and the other as examiner.



When inspecting animals for pests, have them properly restrained to protect both you and the animal.

Not all animals require firm restraining. The amount of restraint needed depends upon the environment and the animal's behavior. Animal behavior varies greatly and handlers must learn to read the animal's body language. Speak to the animal initially in a soothing voice to prevent startling it. Talk to the animal when approaching it. If necessary, speak firmly to the animal. Verbal restraint can be a useful supplement to the physical restraint of animals. For best results, obtain animal handling training from a professional to protect yourself and the animal.

## 2. Identification

After a possible pest has been detected, the second step in an IPM program is to **identify** the organism to determine whether it is indeed the organism causing the discomfort or disorder. The identification of the problem, pest and/or the problem the pest is causing the animal, such as dermatitis, should be made by a veterinarian. Correct pest identification allows the animal manager to gain information about its life cycle and biology so management measures can be targeted at the pest's susceptible life stage. To follow the example of our animal's scratching behavior, it would not make sense to apply flea control measures to alleviate itching symptoms if the animal actually has a scabies mite infestation or a dermal allergy.

## 3. Economical or Medical Significance

After detecting and identifying of the pest, the animal owner, farm operator, veterinarian or pest management applicator must decide if the **pest is present at an economically or medically significant level**. Consult a veterinarian on medical conditions, such as dermatitis and its cause.

In agricultural settings involving livestock, it is often difficult to establish an **economic injury level** above which pest damage occurs. For instance, owners may observe scratching, licking or other behaviors and signs that the animals are irritated. These irritations may not cause any direct or topical (skin surface) problems. But if the irritation persists it may cause the animals enough stress to reduce milk or meat production—an indirect effect and an economic loss. Before the point of economic loss, the pest should be controlled to relieve the stress.

For some animals, pest problems are often not tied to yield or economic loss but rather a **perception by the owner or manager that the animal suffers from the presence and activities of a pest**. Animal owners or veterinarians may make medical judgments on the basis of symptoms caused by pests. These judgments then are used as a basis for pest management decisions.

## 4. Method Selection

After detecting and identifying a pest on an animal and determining that the pest is causing harm, **select a method or methods for managing the pest**. Depending on the situation and the nature of the problem, pesticides may or may not be required. Usually a combination of pest control methods results in the most effective pest management. In any case, the methods should be effective, practical, economical and environmentally sound. Consult with a licensed veterinarian before treating pregnant or lactating animals for flea or mite infestations. These animals or their young may be negatively affected by a pesticide treatment.

## 5. Evaluation

After applying the chosen pest management procedures, **evaluate** their effectiveness. Keeping records and evaluating pest control techniques is necessary in a successful IPM program. Evaluation can include inspecting the animal and its premises to determine the level of pest control achieved and regular checks thereafter to determine if the pest returns to unacceptable levels.

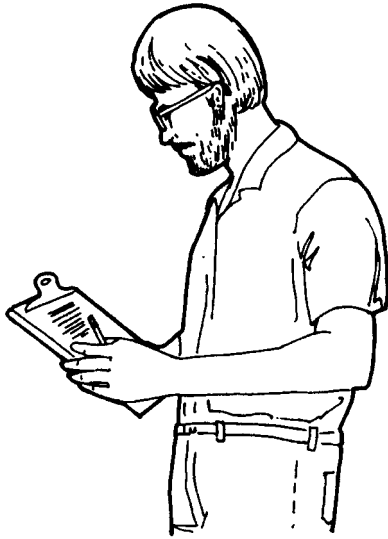

## Techniques Used in Pest Management

Consider all types of pest management strategies that protect animals from arthropod pests. Combining several strategies achieves the most effective and efficient control. Integrated pest management strategies include biological, cultural, mechanical, physical, chemical (pesticides), use of resistant breeds, sanitation in the animal's environment and legal quarantines to prevent spread of pests.

**Biological controls** introduce, encourage and artificially increase plants and animals that are parasites or predators of pests. Biological controls are most commonly used to manage insects, mites and some weeds in agricultural or landscape settings. For instance, releasing parasitic wasps in combination with sanitation practices has reduced the levels of filth flies in barnyards and stables. Nematode-trapping fungi have been identified recently as a means to control internal nematode parasites of cattle.



Parasitic wasps can greatly reduce fly populations in barnyards when used in conjunction with good sanitation practices.

**Cultural pest control** includes maintaining overall good health of the animals. A healthy animal tolerates low levels of pests better than a weak or stressed animal. Animal diets should be well balanced and provided at consistent intervals and in appropriate portions. If animals are kept indoors, provide adequate ventilation to prevent heat stress or the spread of diseases. Provide outdoor animals shelter, especially during severe weather. Make sure that population densities are proportional to available space, food supply and water. Overcrowding may encourage pest outbreaks, whether in a kennel, barn or pasture setting. Proper and routine grooming reduces the opportunity for pests to become established.

Animal ailments can be influenced by the species, diet, living conditions and treatment of the animal by the owner/manager. When any one or a combination of these things is unsatisfactory, the animal is predisposed by poor living conditions to acquire a pest problem. A healthy animal living in a stress-free and sanitary environment is less likely to suffer pest problems.



Cultural controls include proper animal diet and nutrition, densities, housing, and other environmental conditions such as clean, dry pen areas and travelways.

**Mechanical tools** for animal pest management may include grooming combs, brushes and flea combs with closely spaced teeth to monitor for insects and ticks. Electronic devices such as lights

that attract flying insects may be used around barns or other animal quarters to reduce some nuisance pests. Recognize that beneficial flying insects may also be attracted and killed. Trapping rodents that may be carriers of pests is also a preventive mechanical control measure. Ultrasonic collars and other devices have not been found to be effective.

**Physical control** of animal pests may include the use of sticky flypaper to reduce nuisance flying insects in confined areas. Physical control may also include cages that separate animals from one another. Preventing contact between animals reduces the spread of insects from infested animals to non-infested animals. When an infested animal is removed from a cage, stall or pen, thoroughly clean and disinfect the area to prevent contamination of the next animal placed there.

Use **pest-resistant breeds** and breeds adapted to the conditions of the area where they are raised to avoid or reduce the effect of pests. Using breeds that tolerate the climatic changes and temperature extremes that occur in Michigan also reduces the likelihood of stress and pest problems. Some animals have been bred for disease resistance and other qualities that result in reduced problems, while other species still show signs of intolerance even in low-stress situations.

**Sanitation** and habitat modification are the foundation of most animal pest management programs. Keeping barnyards, stables, kennels, exercise areas and surrounding areas as clean as possible discourages pest invasion by eliminating food sources and places to breed and live. Cleaning animal bedding and the surfaces of cages and other animal confinement with disinfectants kills pathogens and reduces the spread of disease.



Sanitation practices around facilities help to reduce pest pressure by eliminating their habitat and food source. This is especially important with fly control and manure management.



Improving drainage and preventing water accumulation will reduce pest populations.

**Quarantines** help reduce the spread of pest problems. When introducing a new animal to an existing group of animals, isolate the new animal and observe it for a period of time to confirm that it is pest free before grouping it with other animals. Within an established herd, flock or group of animals, separate those that are suspected to be sick or infested with a pest until the problem is identified and corrected.

In some pest situations, veterinarians or licensed veterinary technicians may not differentiate between pest management and medical treatment of the animal; that is, it may be necessary to treat the pest-induced condition medically. Heavy flea infestations on dogs, for example, can lead to secondary dermatitis, flea bite allergies or anemia that require veterinary care. The fleas are considered the arthropod pest that caused these undesirable conditions on the animals, but the conditions are treated medically. It is necessary to eliminate the fleas from the animals to prevent the problem from reoccurring.

Adopting a holistic, “IPM attitude” toward the management of pests of animals reduces pest problems. It is possible to manage a pest without any true medical treatment. Simply changing environmental conditions may prevent or eliminate a pest. Veterinarians may need to consult entomologists or commercial pesticide applicators for advice on pest life cycles or management strategies.

**Pesticides** are used in IPM programs for animal pests. Often, they are used in combination with other methods of prevention and control or used when other methods have failed or do not apply. For example, there are no effective environmental, cultural or other management options for deer flies and horse flies. Thus, insecticides or repellents on animals are the most reliable pest management alternatives.

Sometimes pests can be managed effectively with drugs or chemicals that veterinarians administer or prescribe. When a product is labeled as a drug, it is approved and regulated by the Food and Drug Administration, not the Environmental Protection Agency. An example of a drug that has antiparasitic properties is ivermectin (under trade names such as Ivomec®). This drug is injected, sprayed or given orally to an animal to rid the animal of certain ectoparasites and endoparasites. An example of an insecticide that is given to animals like a drug is stirofos (Rabon®). It can be used as a feed additive to cattle rations for controlling fly maggots in manure.

Some animals treated with a drug and later exposed to another chemical pest management treatment have gotten sick. It is important that owners or animal managers are made aware of the treatments administered to their animals and that they communicate this information to other handlers of the animal. Animal groomers, breeders, farm managers and farm workers should ask for this information before administering any type of pest treatment. Ask product sales representatives, the manufacturer or a veterinarian about any possible negative interactions that may result between the products you use and other products to which the animal may be exposed. Because the animal cannot control these situations you are responsible for this knowledge.

The best way to maintain a pest-free and healthy environment for animals is to deal with pests in an IPM program where many management tactics are employed and pesticides and drugs are used when necessary. Treating only the damage caused by a pest and not controlling the pest results in future injury. Animal pest problems should be controlled through both environmental management and animal treatment.

Pesticide use on and around animals requires special care. **Pesticides may be toxic to the animals being treated.** The applicator must consider **dose-response relationships** and pesticide choice carefully when making applications. Be aware that smaller animals cannot tolerate the same dose of certain pesticides as well as larger animals.



**When administering pest management treatments, extreme care must be taken to provide the proper dose for the size, age, species and condition of the animal.**

On food animals such as beef cattle or dairy cows, pesticide use must be balanced with residual activity of the pesticide on or in the animal's bodies. The applicator must be aware of the regulations regarding pesticide use and slaughtering intervals (withdrawal times) or milk-withholding times. An applicator may need to consult a veterinarian to determine the appropriateness and timing of pesticide applications on animals. Before applying any pesticide to an animal or its environment, the applicator should read and thoroughly understand the directions for use on the label.



---



## Chapter 1 – Review Questions

**Write the answers to the following questions and then check your answers with those in the back of this manual.**

1. What unique external characteristics do adult insects have?
2. Which is NOT a type of mouthpart for insects?
  - a. Piercing-sucking
  - b. Filtering
  - c. Siphoning
  - d. Sponging
  - e. Chewing
3. \_\_\_\_\_ is characterized by egg, larval, pupal and adult stages and includes the majority of insects.
  - a. Gradual metamorphosis
  - b. No metamorphosis
  - c. Complete metamorphosis
4. What is a host?
5. Endoparasites live INSIDE the host body. (True or False)
6. What is dermatitis? Name some causes of dermatitis.
7. List the four groups of important animal insect pests.

8. Define IPM and explain the five components of an IPM program.
9. Why is early detection of pests important?
10. Once observed, why must the animal manager identify the pest?
11. In what settings are economic injury levels of greatest concern?
12. What is an important and final step of an IPM program?
  - a. Monitoring.
  - b. Selecting a method.
  - c. Detection.
  - d. Evaluation.
  - e. Re-treatment.
13. What must be considered when pesticides are used on or around animals?
14. List five or more strategies/techniques used in IPM programs and briefly describe each.

# Key To Insects, Ticks and Mites of Medical and Veterinary Importance

Source: North Carolina State University Cooperative Extension Service

- 1. Having 6 or 8 legs (Fig. 2) ..... 2
  - Legless and wormlike maggots (Fig. 3) ..... 34
- 2. Having 6 legs and a distinct head (Fig. 2A) ..... 3
  - Having 8 legs without a distinct head (Fig. 2B)..... 32

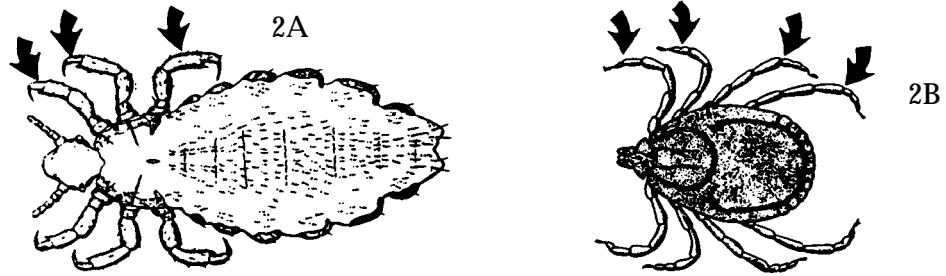

- 3. One pair of wings (Fig. 4A) ..... 4
  - Two pairs of wings or no wings (Fig. 4B, C) ..... 21

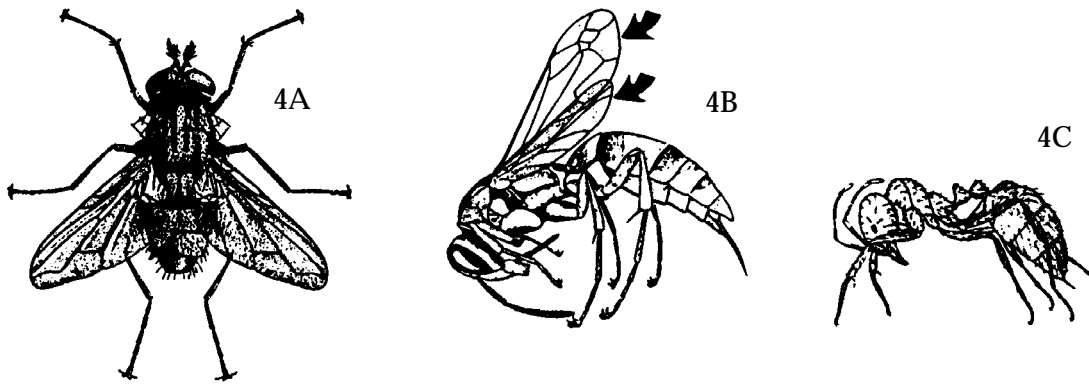

- 4. Antennae (feelers) with 10 or more distinct segments (Fig. 5A) ..... 5
  - Antennae with 3 segments (Fig. 5B) or the apical segments more or less fused (Fig. 5C) ..... 7

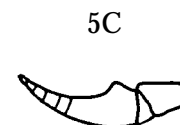
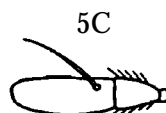
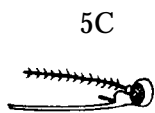

5. Short antennae with 10 or 11 segments (Fig. 6A); wing veins slender at rear (Fig. 6B); slightly hump-backed fly 4 mm long or less; bite usually painless at first but later causes swelling and pain ..... BLACK FLY or BUFFALO GNAT
- Longer antennae with 12 to 16 segments (Fig. 6C); wing veins all about the same width (Fig. 6D) ..... 6

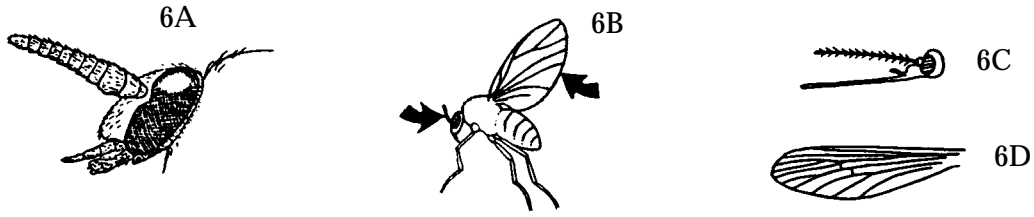

6. Wings not very hairy, costa vein ending before wing tip (Fig. 7A); bloodsucking fly (Fig. 7B) 0.5 to 5.0 mm long ..... BITING MIDGE, PUNKIE, NO-SEE-UM
- Wings scaly and with numerous veins, costa vein continuing around wing tip (Fig. 7C); slender, long-legged fly (Fig. 7D) with wings 3 to 4 mm long; has slender proboscis for sucking blood ..... MOSQUITO

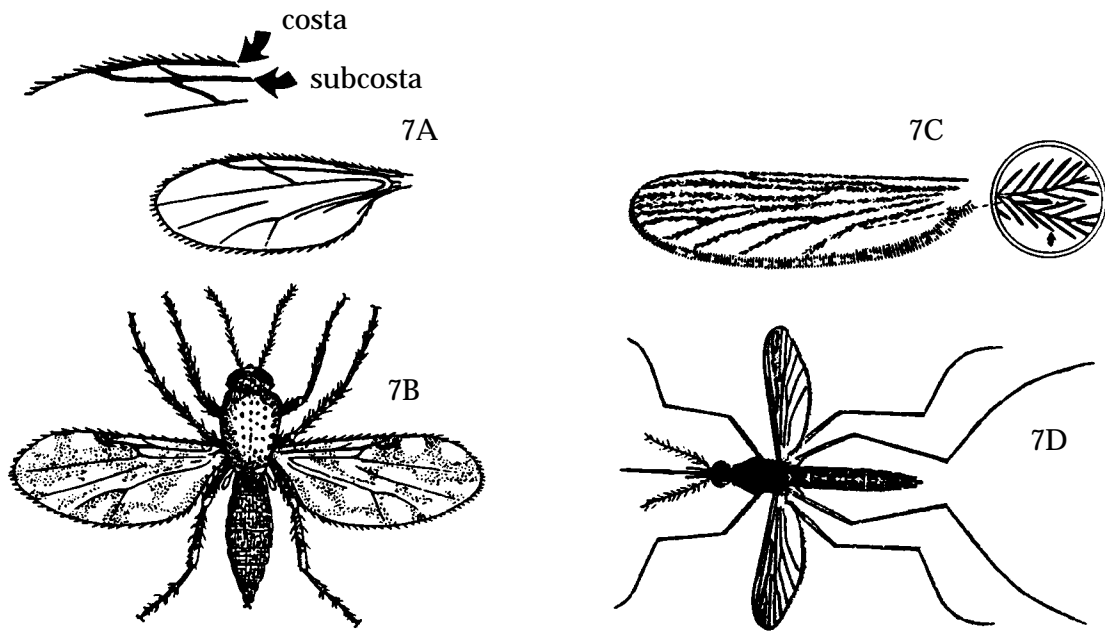

7. Each wing with 4 or 5 cells along rear edge (Fig. 8A) ..... 8
- Each wing with 3 or fewer cells along rear edge (Fig. 8B) ..... 9



8. Third wing vein branched with vein 3A long and vein 3B ending behind wing tip (Fig. 9A); abdomen-flattened; small- to large-bodied fly (Fig. 9B) 10 to 19 mm long; female inflicts painful bite.....HORSE or DEER FLY

Third wing vein branched with vein 3A short and vein 3B ending before wing tip (Fig. 9C); dusky-winged, nonbiting fly (Fig. 9D) 15 to 20 mm long; wasplike in appearance; bronze or primarily black abdomen ..... BLACK SOLDIER FLY

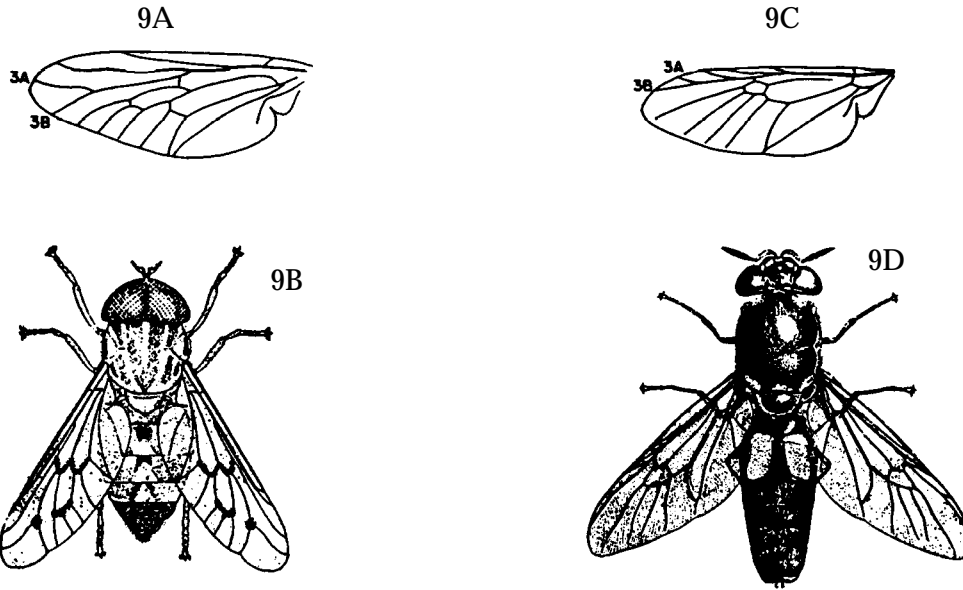

9. Second antennal segment with seam (Fig. 10A); mesonotal suture on thorax goes all the way across (Fig. 10B) ..... 10

Second antennal segment without seam (Fig. 10C); mesonotal suture absent or note reaching all the way across (Fig. 10D) ..... 11

10. Hypopleura (area just above base of hind legs) bare or with sparse, fine hairs (Fig. 11A) ..... 13

Hypopleura with row of strong bristles or with long, dense hairs (Fig. 11 B) ..... 19

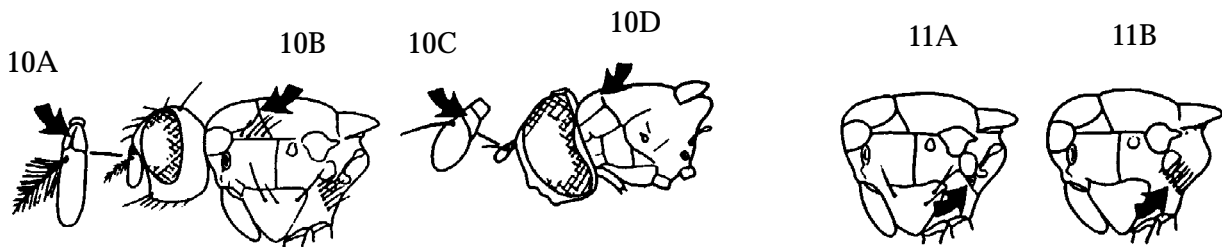

11. Oral vibrissae (hairs near the front of the mouth) usually present (Fig. 12A); nonbiting, gray to black fly only about 1.2 mm long; passes easily through 16-mesh screen ..... EYE GNAT

Oral vibrissae usually absent (Fig. 12B); fly 15 to 18 mm long ..... 12

12. Spurious (extra) vein present (Fig. 13A) and anal cell nearly reaches wing margin (Fig. 13B); hairy, brownish to black, beelike fly about 15 mm long; has mouthparts but doesn't bite.... DRONE FLY  
 Anal cell short (Fig. 13C); hairy, brownish to reddish fly about 18 mm long; mouthparts absent ..... BOT FLY

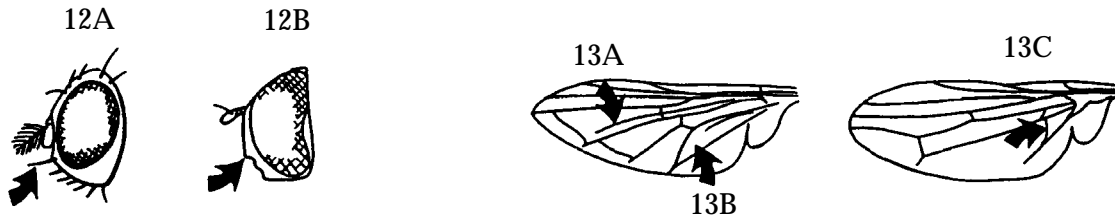

13. Slender, shiny black, nonbiting fly (Fig. 14) about 5 mm long ..... GARBAGE or DUMP FLY  
 Fly dull, not shiny ..... 14

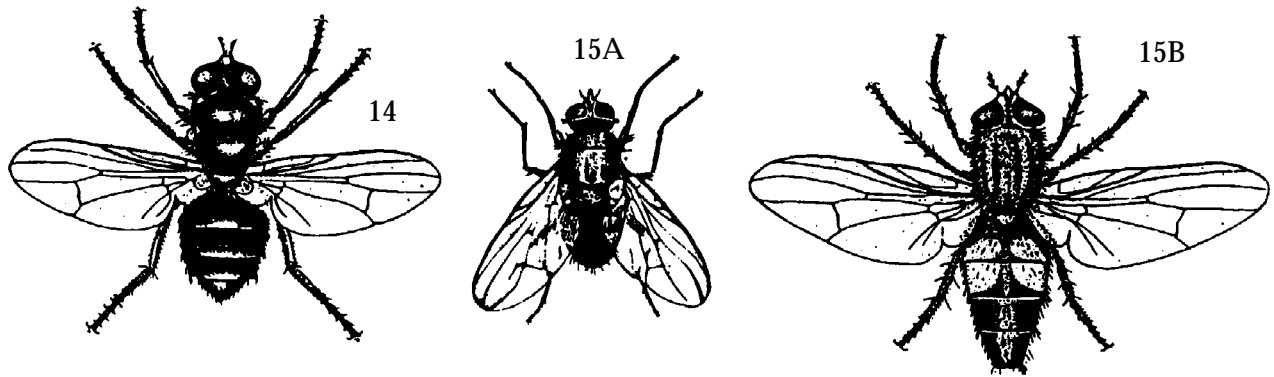

14. Fly usually less than 6 mm long ..... 15  
 Fly usually longer than 6 mm ..... 16

15. Brownish-gray to black with yellowish cast to body; blood-sucking; 3.5 to 4 mm long; set of parallel stripes just behind head (Fig. 15A); brownish-red antennae; usually a pest of cattle and horses ..... HORN FLY  
 Slender, nonbiting fly 5 to 6 mm long; dark-colored body with or without stripes (Fig. 15B); hovering and jerky pattern of flight ..... LITTLE HOUSE FLY

16. Blood-sucking fly with sharp mouthparts which protrude from head (Fig. 16A); body 6 to 8 mm long; 4 dark, longitudinal stripes on thorax; several dark spots on abdomen' "squats" when at rest ..... STABLE FLY  
 Mouthparts blunt, not protruding (Fig. 16B); nonbiting fly ..... 17

17. Pale spot on top of thorax near abdomen; 4 dark, sometimes indistinct, stripes on thorax; abdomen black or black and red; body about 8 mm long (Fig. 16B) ..... FALSE STABLE FLY  
 Not as above ..... 18

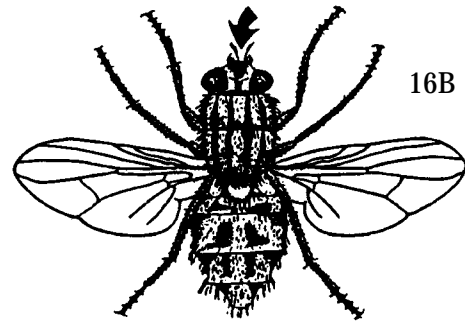
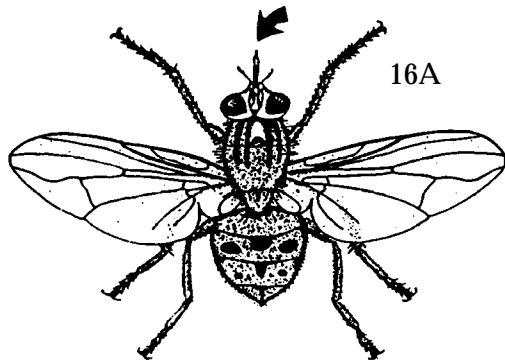

18. Abdomen yellow or partially yellow with dark line down the middle; gray fly (Fig. 17A) about 6.5 mm long with 4 dark, lengthwise stripes on thorax ..... HOUSE FLY  
 Abdomen primarily black with orange base (female) or orange-brown with black base and dorsal stripe (male); thorax gray with 4 dark, lengthwise stripes (Fig. 17B); body 6 to 8 mm long; commonly feeds on moist animal secretions ..... FACE

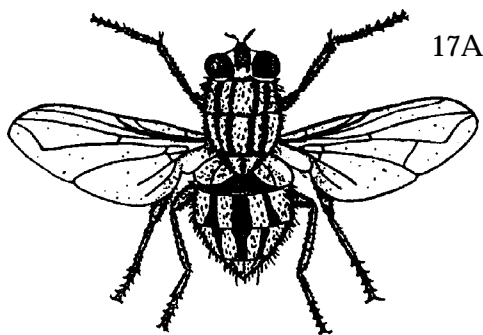

19. Hypopleura (area above base of hind legs) obscured by long, usually dense hairs; mouthparts absent; body about 13 mm long with 2 bands of yellow and white hairs across it (Fig. 18A); reddish-orange hairs at tip of abdomen and on legs; wings dark brown to black ..... CATTLE GRUB FLY  
 Hypopleura with a row of strong bristles (Fig. 18B) ..... 20

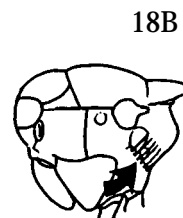
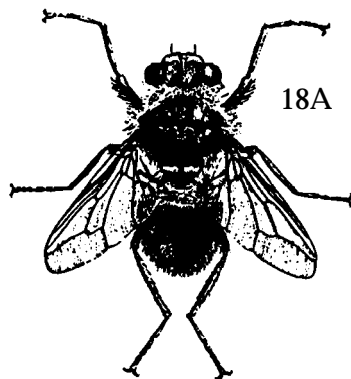

20. Notopleura (“shoulder” of the thorax) usually with 4 bristles (Fig. 19A); gray fly about 10 to 13 mm long; 3 black stripes on thorax; light and dark checkerboard pattern on abdomen (Fig. 19B) ..... FLESH FLY

Notopleural with only 2 bristles (Fig. 19C); black or metallic-colored fly 6 to 14 mm long; no stripes or checkerboard pattern (Fig. 19D) ..... BLOW FLY

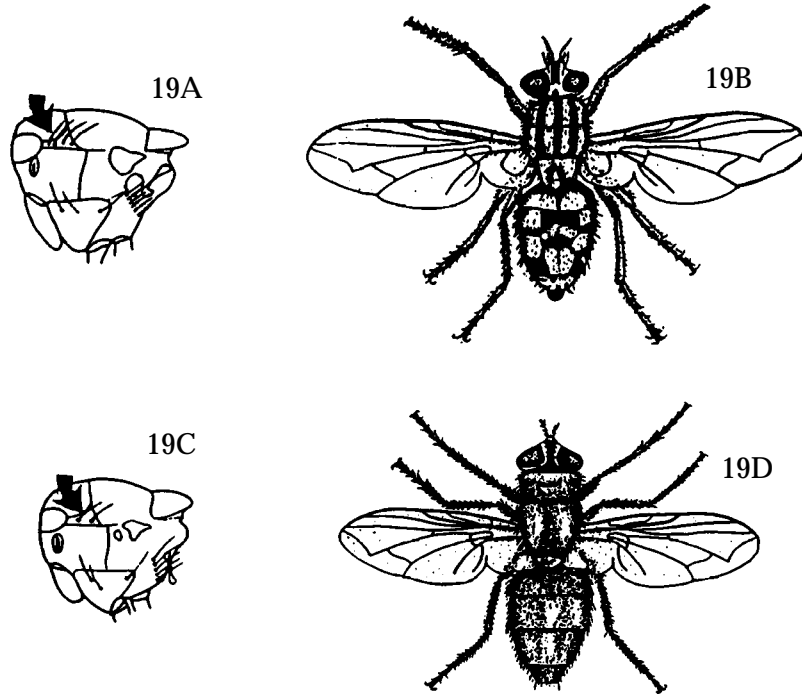

21. Two pairs of wings; constricted “waist” without nodes (bumps); smooth-bodied, stinging insect (fig. 20A) 13 to 25 mm long; color variable; associated with papery nests under or above ground ..... HORNET, WASP, YELLOW JACKET

No wings; “waist” constricted with nodes (Fig. 20B) or note constricted (Fig. 20C) ..... 22

22. Constricted “waist” with nodes (Fig. 20B); body usually reddish or dark brown and 3 to 6 mm long; stinging ant associated with mounds 35 cm or more in diameter and 20 to 25 cm high ..... FIRE ANT

No constricted “waist” as above ..... 23

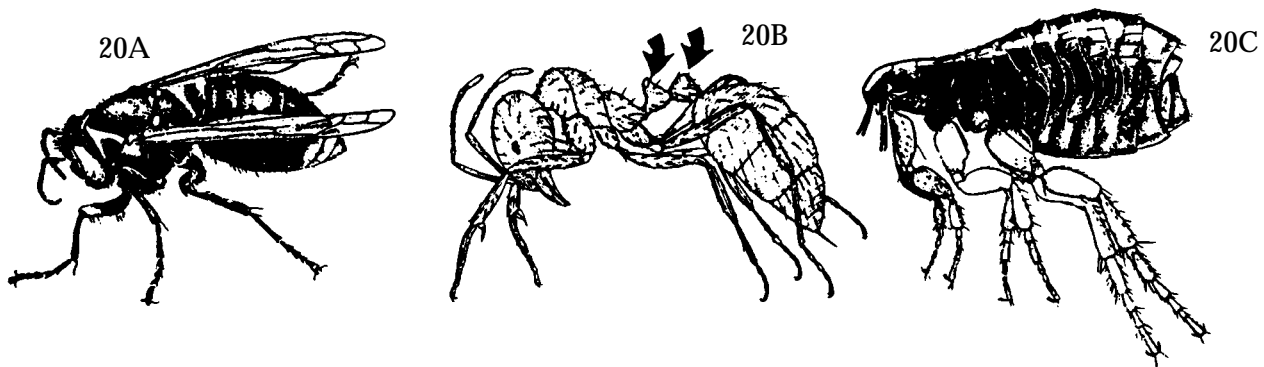

23. Body flattened laterally (from side to side); spiny, hard-skinned insect (Fig. 20C) 1 to 2.5 mm long; hind legs modified for jumping ..... FLEA

Body not flattened laterally ..... 24



24. Pest 1 mm or less in length; associated with slightly larger, 8-legged animals which are otherwise similar in appearance (Fig. 21A, B) (key out the larger, 8-legged pests) ..... 31  
 No association as above; all animals with 6 legs; size variable; body somewhat flattened dorsoventrally (from top to bottom) (Fig. 21C) ..... 25

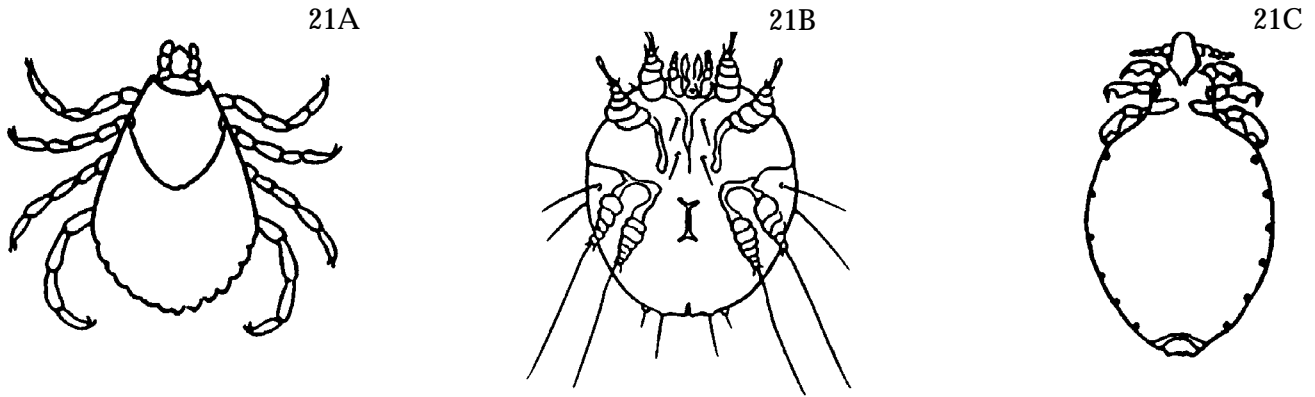

25. Chewing mouthparts; yellowish-white louse with broad, flat, reddish head (Fig. 22A); body up to 1.5 mm long with 8 dark crossbands on abdomen ..... 26  
 Piercing-sucking mouthparts; body somewhat flattened dorsoventrally (from top to bottom) (Fig. 22 B) ..... 27

26. Feeding on cattle ..... CATTLE BITING LOUSE  
 Feeding on skin or feathers of poultry ..... CHICKEN BODY

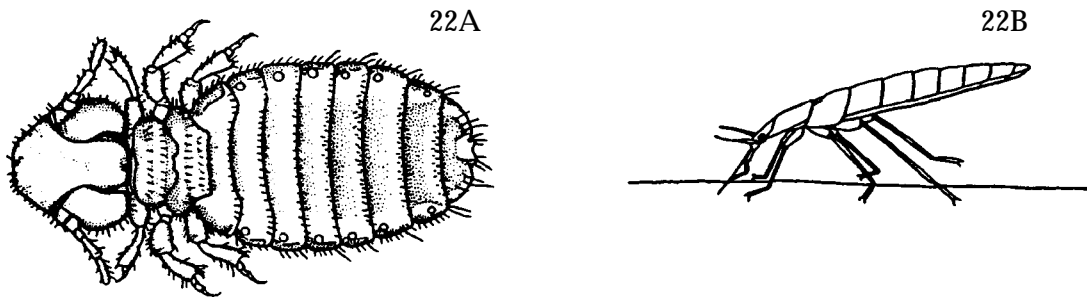

27. Jointed beak (Fig. 23A); reddish-brown, oval, flattened insect up to 9 mm long; small, padlike wing remnants (Fig. 23B); pronotum (just behind head) collarlike ..... BED BUG  
 Beak not jointed, sometimes retracted into head ..... 28

28. Needlelike mouthparts exposed (Fig. 24A); short, thick legs with apical spurs; body about 6 mm long; blood-sucking parasite of sheep ..... SHEEP KED  
 Mouthparts retracted into head; blood-sucking louse (Fig. 24B) ..... 29

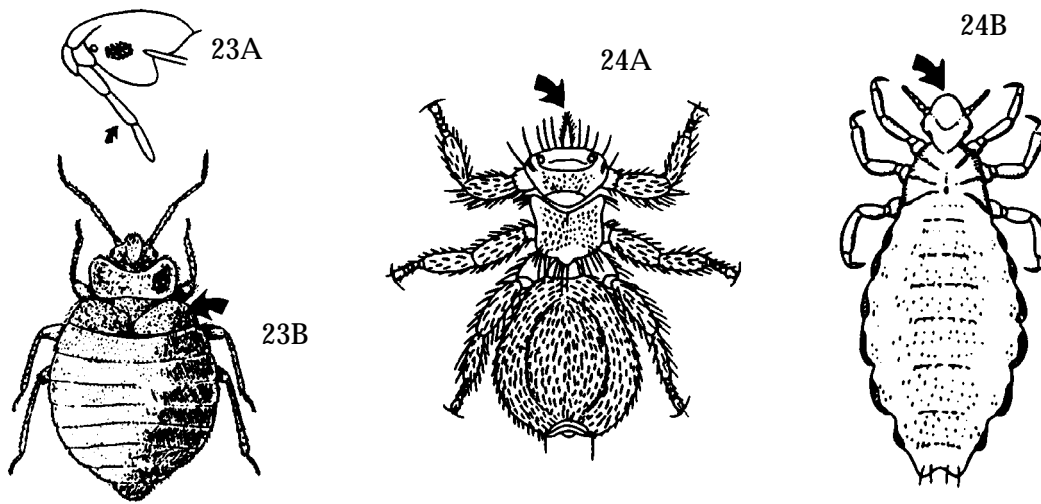

29. Parasite of hogs; oval, grayish-brown louse up to 6 mm long; brown and black markings on body; legs clawlike (Fig. 25A) ..... HOG LOUSE  
 Parasite of man; grayish-white louse 4 mm or less in length ..... 30
30. Abdomen longer than wide; body up to 4 mm long without hairy tubercles (Fig. 25B); all legs about equal in size ..... HEAD and BODY LOUSE  
 Abdomen about as long as wide; body up to 2 mm long with hairy tubercles (Fig. 25C); front pair of legs more slender than other pairs ..... CRAB LOUSE

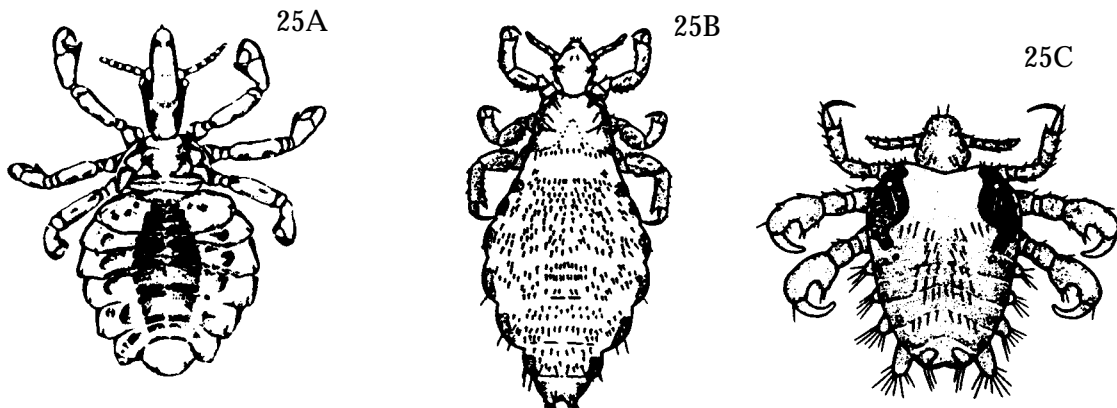

31. Abdomen constricted to form a narrow "waist" (Fig. 26A) ..... 32  
 No constricted "waist" (Fig. 27); bloodsucking parasite of man and animals; some immature stages 6-legged ..... 33

32. Spider with black, globular abdomen about 9 by 13 mm with red or yellow, hourglass marking on underside (Fig. 26A, B) ..... BLACK WIDOW SPIDER  
 Grayish- to reddish-brown spider with black, fiddlelike marking on the head and thorax; body 7 to 13 mm long with a leg span about the size of a half dollar (Fig. 26C) ..... BROWN RECLUSE SPIDER

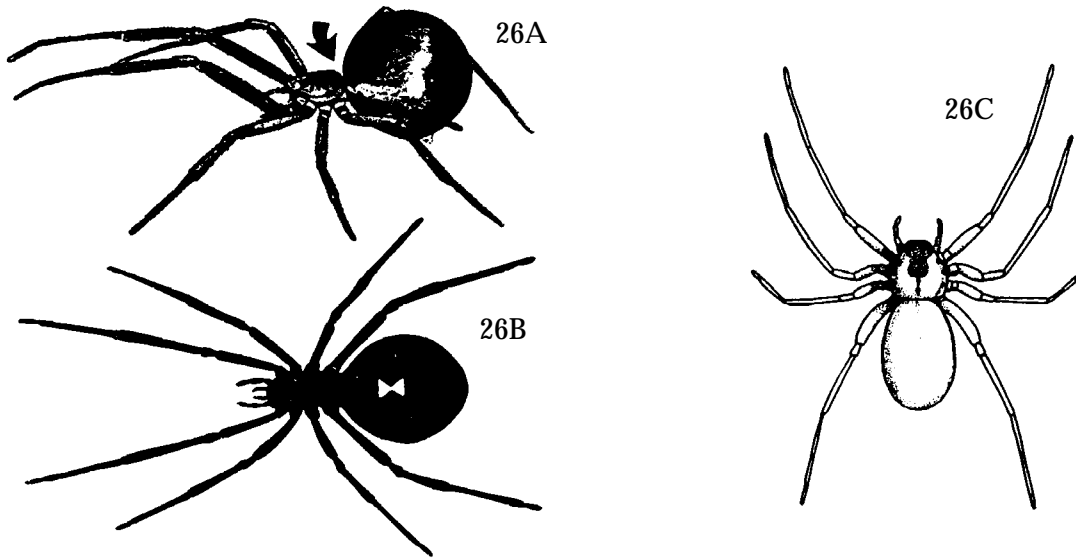

33. Hairless body from 0.5 mm up to 7 mm long (immature to adult) (Fig. 27A); usually brown, reddish brown or gray ..... TICK  
 Body with long or short hairs (Fig. 27B, C); body usually 1.25 mm long or less; color variable ..... CHIGGER or MITE

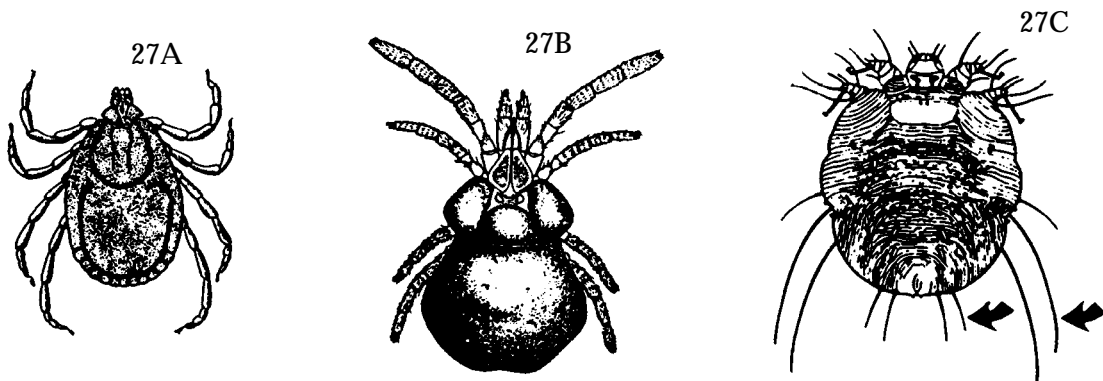

34. With a definite head (Fig. 28A) ..... 35  
 Without a definite head (the mouthparts are tucked into the thorax, Fig. 28B) ..... 36

35. Body large and flattened, 12 to 27 mm long when fully grown; creamy white to reddish brown; develops in decaying organic matter (Fig. 28A) ..... BLACK SOLDIER FLY LARVA  
 Slender, aquatic larva up to 10 mm long or curled pupa; transparent to greenish brown; develops in still rather than running water (Fig. 29A and B) ..... MOSQUITO LARVA and/or PUPA

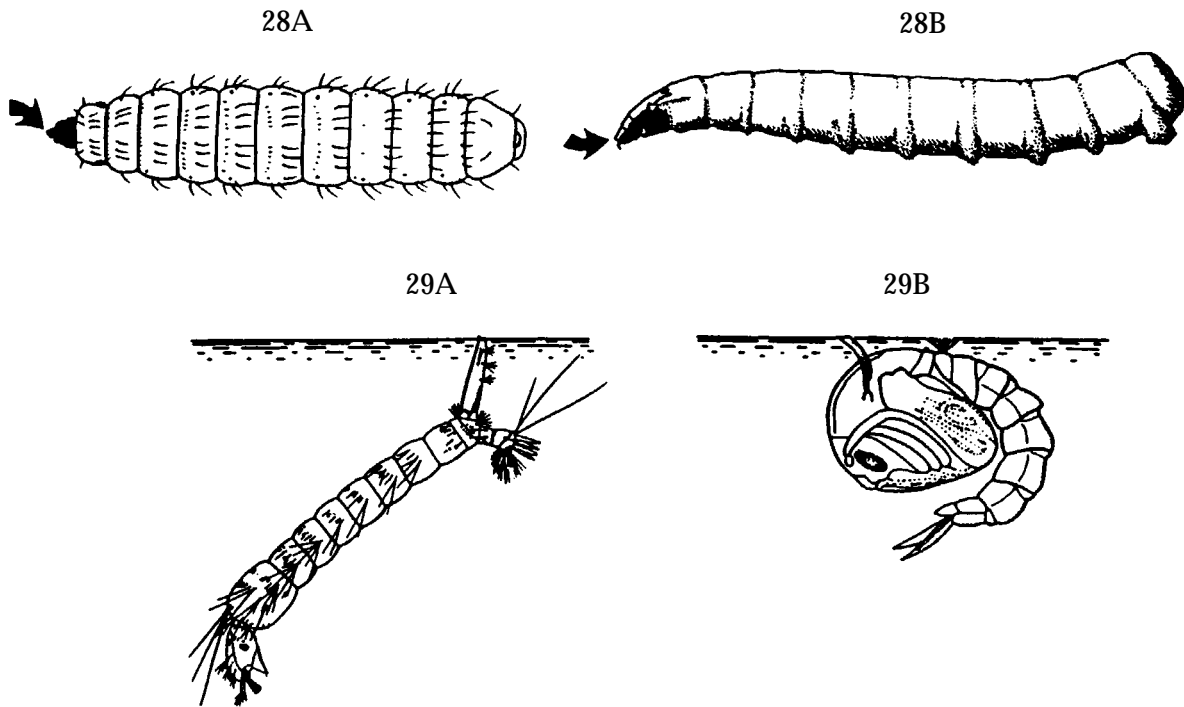

36. Body with pointed projections on each segment (Fig. 30A); posterior spiracles (breathing openings) on small bumps; white to light brown body up to 8 mm long ..... LESSER HOUSE FLY LARVA  
 Body smooth or with short spines; no long pointed projections; posterior spiracles not on bumps (Fig. 30B) ..... 37

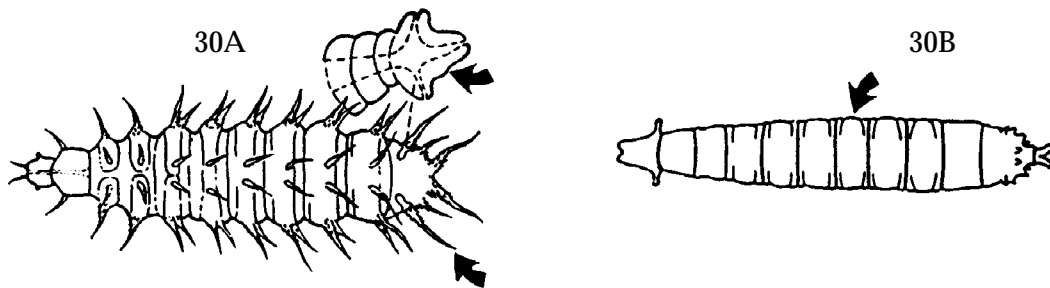

37. Leathery; aquatic; larva up to 20 mm long, with long, taillike breathing tube (Fig. 31A) ..... RAT-TAILED MAGGOT  
 Larva without a taillike process (Fig. 31B) ..... 38

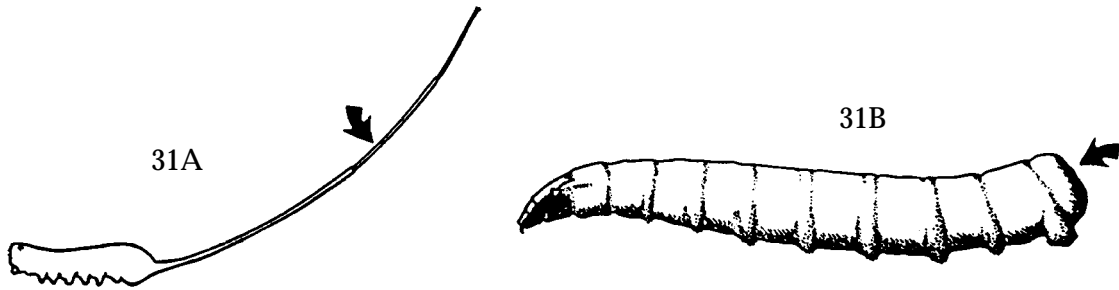

38. Hard, dark line (peritreme) present around hind spiracles; each spiracle with 3 distinct slits (Fig. 32A) ..... 39  
 No peritreme around hind spiracles (Fig. 32B); or, if peritreme present, then 3 slits absent (Fig. 32C) ..... 45

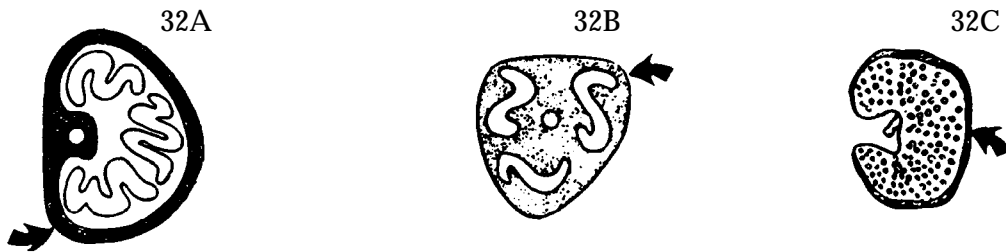

39. Slits of hind spiracles straight (Fig. 33A) ..... 40  
 Slits of hind spiracles strongly curved (Fig. 33B) ..... 44

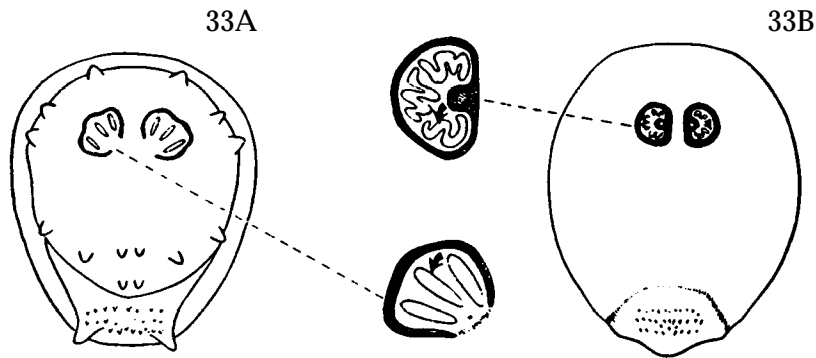

40. Peritreme of hind spiracle very thin on top and bottom (Fig. 34A); spiracles slightly elevated and, when viewed from rear, slanted toward each other; hardened, spiny larva at least 10 mm long when fully grown; develops in decaying organic matter ..... BLACK GARBAGE or DUMP FLY LARVA  
 Peritreme complete (Fig., 34B) or with only lower portion missing (Fig. 34C) ..... 41

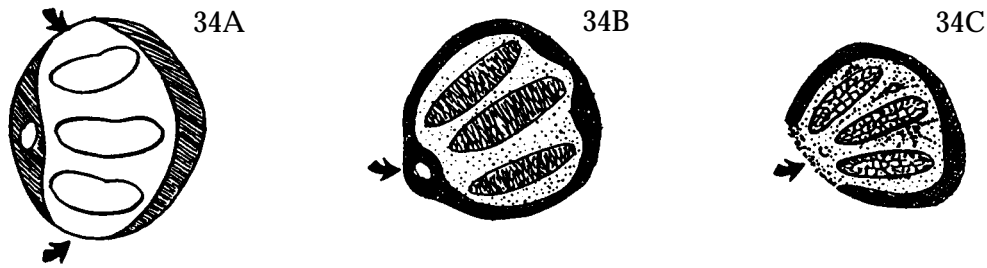

41. Hind spiracles with peritreme complete (Fig. 35A); at least one of the two prothoracic spiracles (close to front end) with 8 or more openings (Fig. 35B, a green bottle fly) or prothoracic spiracles with 6 or less openings (Fig. 35C, a bronze bottle fly); yellowish to white maggot up to 14 mm long; develops in decaying organic matter, sometimes carrion or animal wounds ..... BOTTLE FLY LARVA  
 Hind spiracles with peritreme incomplete, not enclosing a "button," (the "button" is a tiny, round pale area which is sometimes hard to see, Fig. 35D) ..... 42

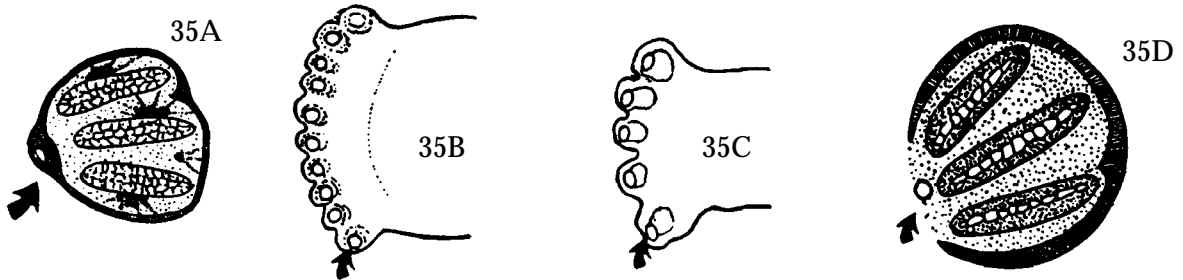

42. Slits of hind spiracle not pointing toward opening in peritreme (Fig. 36A); white to yellowish maggot 10 to 22 mm long when fully grown; develops in wounds, carrion or excrement .... FLESH FLY LARVA  
 Slits of hind spiracle pointing toward opening in peritreme (Fig. 36B); at least one of the prothoracic spiracles (close to front end) with 10 or more openings (Fig. 36C) ..... 43

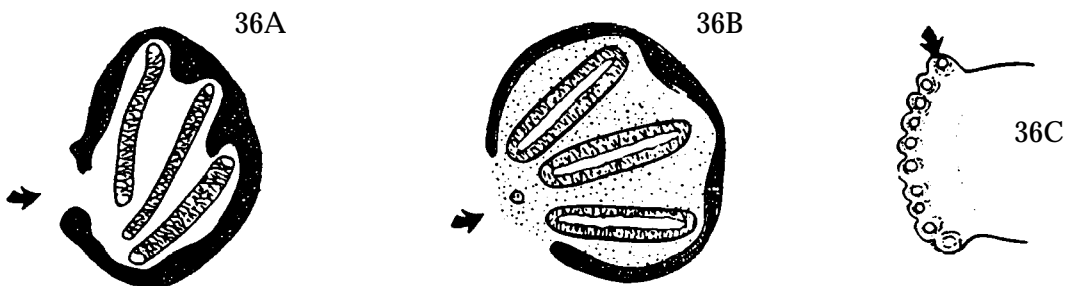

43. Hind spiracle with button distinct or absent, walls of slits with lateral swellings (Fig. 37A); white or yellowish maggot up to 18 mm long; develops only on dead animal tissues ..... SECONDARY SCREWWORM

Hind spiracle with button present, walls of slits without lateral swellings (Fig. 37B); white or yellowish maggot up to 17 mm long; develops in decaying organic matter, carrion or animal wounds.  
..... BLACK BLOW FLY LARVA

44. Peritreme of hind spiracle thick (Fig. 38A); nearly white maggot up to 13 mm long; common in moist feces and decaying organic matter ..... HOUSE FLY LARVA

Peritreme of hind spiracle thin (Fig. 38B); white maggot 6.5 to 7.5 mm long when fully grown; common in fresh bovine feces ..... HORN FLY LARVA

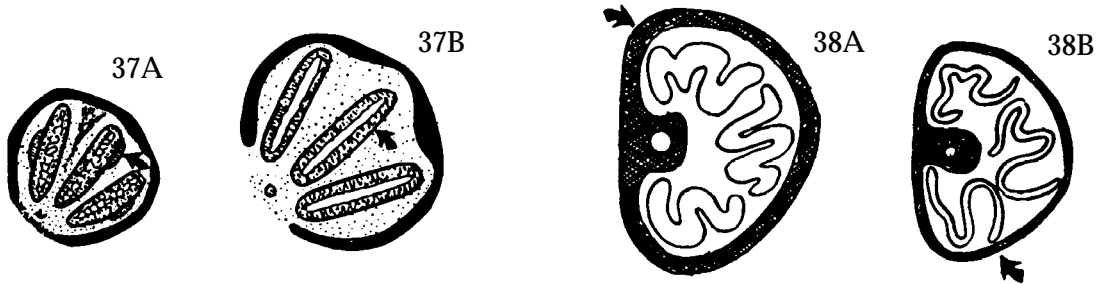

45. Small or slender, maggot-type larva usually, but not always, less than 13 mm long, tapering toward the head (Fig. 39A); develops in decaying organic matter ..... 46

Large, robust larva with very stout spines (Fig. 39B); over 15 mm long when fully grown; internal parasite of animals ..... 48



46. Button of hind spiracle centrally located (Fig. 40A); creamy white to pale yellow maggot up to 12 mm long; develops in moist, decomposing organic matter (usually not in manure piles) ..... STABLE FLY LARVA

Button of hind spiracle not centrally located (Fig. 40B) ..... 47

47. Slits of hind spiracles strongly curved (Fig. 41A); yellowish maggot up to 13 mm long; develops in fresh bovine manure ..... FACE FLY LARVA

Slits of hind spiracles not strongly curved (Fig. 41B); grayish to cream-colored larva 12 to 18 mm long when fully grown; develops in decaying organic matter, including manure ..... FALSE STABLE FLY LARVA

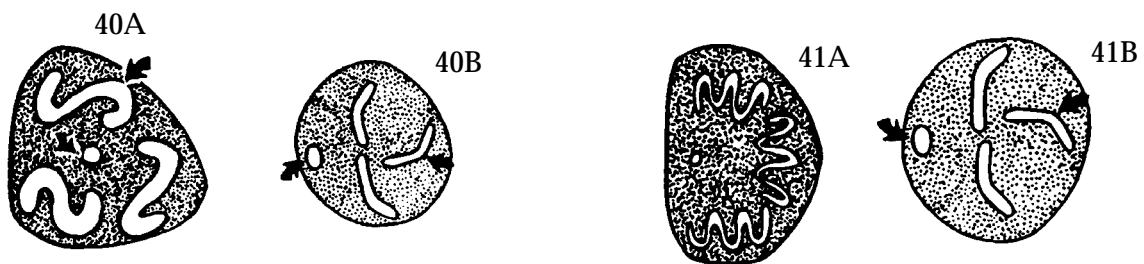

48. Hind spiracles with 3 distinct, slightly curved slits (Fig. 42A); yellowish- to dirty-white larva 17 to 24 mm long when fully grown; spines dark brown; internal parasite of horses ..... HORSE BOT FLY LARVA

Hind spiracle without 3 distinct slits ..... 49

49. Button of hind spiracle not centrally located or enclosed; opening toward button wide (Fig. 42B); white when young; mature larva black, up to 28 mm long and 13 mm wide; subcutaneous along back line of cattle ..... COMMON CATTLE GRUB

Button of hind spiracle enclosed, centrally located (Fig. 42C); larva more than 15 mm long when mature; body with stout spines ..... SHEEP BOT FLY

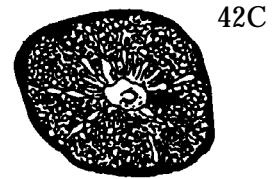
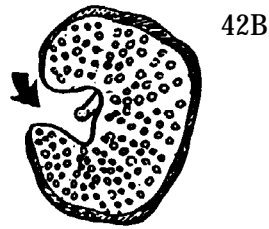
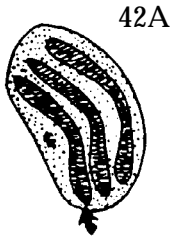



---

## CHAPTER 2

# PESTICIDES AND THEIR USE FOR LIVESTOCK PEST MANAGEMENT

### LEARNING OBJECTIVES:

After you finish studying this chapter, you should be able to:

- Differentiate between several pesticide chemistries registered for use on animals and the precautions necessary when handling or using them.
- Describe symptoms of animals when overexposed to different insecticide chemistries.
- Identify the factors to consider when choosing a formulation.
- Explain the various methods of pesticide applications and application equipment appropriate for animals and their environment.
- List the precautions necessary for safe pesticide applications on an animal or in its environment.
- Explain how and when pesticides may be incompatible.

---

### PESTICIDES

Pesticides are substances or mixtures of substances intended to prevent, destroy, repel or manage pests. In addition, the Federal Insecticide, Fungicide and Rodenticide Act (FIFRA) has extended the legal definition of a **pesticide** to include compounds intended for use as plant growth regulators, defoliants or desiccants, even though they are not normally used as pest management agents, and are usually not effective as such.

More specifically a pesticide may be defined as any chemical used to control pest populations directly or to prevent or reduce pest damage. Though the ending “cide” is derived from the Latin word *cida*, meaning “to kill,” not all pesticides actually kill the target organism. For example, some fungicides may simply inhibit the growth of a fungus without killing it; attractants and repellents lure a pest to or divert it from a particular site.

The following chapters discuss a wide variety of insects, mites and ticks that afflict animals in agricultural settings. Activities or infestations by these pests can, in many cases, severely compromise the health and well-being of individual animals. Though insecticides (control insects) and

acaricides (control arachnids) are not the only means for controlling or preventing these pests from becoming problems, they often play an important or even a key role. Sometimes, one must choose between insecticide applications and drug treatments to deal with insect pests that are true parasites.

Pesticides are a mixed blessing. For example, they contribute significantly to agricultural productivity and to improved public health by managing disease-carrying pests, but they can adversely affect people, nontarget organisms such as fish and wildlife, and the environment.

Before using insecticides, think about the components of an integrated pest management program (see Chapter 1). For insect, mite or tick pests of animals, this means developing management systems that employ the full range of physical and cultural methods available to manage the pests before insecticides are used. For example, in the case of filth fly (flies associated with poor sanitary conditions) problems in feed lot cattle areas, insecticides should not be used until good farm sanitation practices have been established. Removing manure and using good waste management practices help assure that flies will not reach levels that require insecticide use. Also,

purchasing animals from reputable breeders is a cultural preventive measure that may mean lice and mange mite infestations can be avoided or kept in check.

In another example, flea control for pet dogs or cats must include sanitation and control around the home to eliminate larval fleas and flea eggs. Fleas do occur in very clean houses, but sanitation is essential for a successful flea management program. Check the animal frequently, especially after it has been at a boarding or grooming facility or veterinarian's office. Other animals at these locations may spread fleas to non-infested animals. Typically, only after an infestation occurs should you consider insecticide use in the home or on the pet, and then only in conjunction with good sanitation practices. The exception may be when a pet has flea bite hypersensitivity. Treatment after a flea population has become established would be too late to avoid the animal's discomfort. In this case, insect growth inhibitor products may be effectively used to prevent a problem from becoming established.

In this chapter, you will learn about the types of pesticide chemistry, formulations, application methods and basic concepts of pest control on animals, and special concerns with pesticide use on and around animals. This knowledge will help you use pesticides safely and effectively. Refer to the *Pesticide Applicator Core Training Manual*, E-2195, Chapter 3, Pesticides, for a review of pesticide classification methods, formulations and chemistry.

## CLASSES OF INSECTICIDES/ ACARICIDES USED IN LIVESTOCK PEST MANAGEMENT

Eleven chemical classes of insecticides and acaricides are used to control pests on or around animals.

1. **Chlorinated hydrocarbons.** This class includes lindane and methoxychlor. Lindane has become a restricted use pesticide for mange mites and lice.

Chlorinated hydrocarbons are easily absorbed through the skin and accumulate in the body. Overexposure can occur from excessive use. Common symptoms of animal chlorinated hydrocarbon poisoning may include hypersensitivity, spasms that begin with the eyelids and progress through the muscle masses toward the tail, loss of coordination, circling and abnormal posture, seizures, salivation, vomiting, coma and death. Continued low dose exposures can cause liver damage.

2. **Organophosphates (OP).** An organophosphate is a synthetic organic pesticide containing carbon, hydrogen and phosphorus. If the product label bears chemical names containing "phosphoro" and recommendations to use atropine plus pralidoxime (2-PAM) as an antidote for poisoning, you can assume the product is an OP insecticide. Organophosphate compounds inhibit cholinesterase (see the Core manual, E-2195, Chapter 6, Pesticides and Human Health). Cholinesterase is a chemical catalyst (enzyme) found in mammals that helps regulate the activity of nerve impulses.

This class of pesticides includes a broad range of insecticides/acaricides such as chlorpyrifos, malathion, DDVP, ronnel, stiriphos and others. Organophosphates are effective against a wide range of insects including fleas and ticks. OPs are commercially available as ready-to-use insecticidal solutions, emulsifiable concentrates, dips, dusts, baits and flea collars.

These products range from acutely to mildly toxic to animals. The body has the ability to break these compounds down, usually in the first 24 hours. Though they are less likely to accumulate in the body than chlorinated hydrocarbons, organophosphates cannot be used in conjunction with one another because they can accumulate during a short period of time immediately following exposure. Find out whether the animal has been administered an oral, systemic OP. If so, do not treat with a topically applied OP. The two products can have a combined effect on cholinesterase activity.

Overexposure to OPs commonly causes such symptoms as increased salivation, inability to coordinate muscular movements (**ataxia**), frequent urination, vomiting, diarrhea, breathing difficulty (**dyspnea**), muscle weakness, tremors (shaking), convulsions, coma and death. The above symptoms are listed in order of severity. An animal may progress from mild symptoms to coma and death in a matter of minutes depending on the extent of the overexposure.

Onset of symptoms after excessive OP exposure usually occurs within hours but may be delayed up to two days. Severity and development of symptoms are influenced by the dosage and the route of exposure (dermal, oral, etc.). If poisoning from an OP is suspected, obtain immediate assistance from a veterinarian and provide them the label of the suspect insecticide. Atropine is the antidote for all levels of organophosphate poisonings.

A commonly reported organophosphate insecticide-related poisoning scenario among all animal types has been from dichlorvos (DDVP). Many

foggers contain DDVP in combination with other cholinesterase-inhibiting insecticides. Reading product labels and following all precautions and directions for use greatly reduces the chance of poisonings.

**3. Carbamates.** Carbamates are similar to organophosphates in activity—they inhibit cholinesterase. Carbaryl, propoxur and methomyl are carbamates. Animals have been the victims of carbamate poisoning by products labeled for use on sites other than on the animal. These include ant traps, products used for home insect control and agricultural products. Methomyl is particularly hazardous because of its inherent toxicity (LD<sub>50</sub> of 17 mg/kg in test animals) and the apparent palatability of the sugar baits in which it is often formulated.

Carbamate poisoning is characterized by excessive salivation, tremors, vomiting, seizures, diarrhea and loss of muscle control. If you suspect carbamate poisoning, contact a veterinarian immediately. Be sure to provide the veterinarian with the label of the suspect insecticide. Atropine is the antidote. Victims of carbamate overexposure display similar symptoms as organophosphate poisonings, but they tend to recover, more completely and more rapidly. Carbamates may cause localized skin reactions on sensitive animals.

**4. Synthetic pyrethroids.** This class of insecticides/acaricides includes permethrin, resmethrin and allethrin. Often the formulations contain a **synergist** (something that enhances the effectiveness of the active ingredient) called piperonyl butoxide, or PBO. By itself, PBO is relatively nontoxic. The synthetic pyrethroids show properties of low mammalian toxicity but good activity against insects, ticks and mites. They do not appear to be readily absorbed through the skin.

Animals mildly affected by pyrethroids and those in the early stages of pyrethroid poisoning often display excessive salivation, vomiting, diarrhea, mild tremors, hyperexcitability or depression. These symptoms may be confused with symptoms of organophosphate or carbamate poisoning. More severely affected animals can have high fevers or lowered body temperature, difficulty breathing, severe tremors, disorientation and seizures. Death is due to respiratory failure. Generally, these signs begin within a few hours of exposure. In the case of excessive dermal exposure, bathe the animal using mild detergent and rinse repeatedly. Initial assessment of the animal's respiratory and cardiovascular condition is important. Further treatment requires veterinarian assistance.

**5. Botanicals.** Rotenone and pyrethrin are derived from plants. They may be synergized (increased activity) in certain formulations with PBO. With the exception of nicotine, plant-derived insecticides have shown low mammalian toxicity.

**6. Repellents.** Repellents, though not strictly insecticides, help prevent animal pest establishment. Diethyl-meta-toluamide (DEET), butoxy-polypropylene glycol and dipropyl isocinchomeronate are repellents with activity against certain arthropods. Some formulations containing synthetic pyrethroids are repellents. There have been reported deaths of both cats and dogs after excessive exposure to DEET. The most common signs of poisoning include vomiting, tremors, ataxia and incoordination, hyperactivity, excessive salivation, depression, loss of appetite, seizures and breathing difficulty. Be watchful of possible overexposure symptoms when combining repellents with other pesticide treatments.

**7. Lime sulfur** (calcium polysulfide). Sulfur and lime-sulfur are two of the oldest insecticides. Lime-sulfur is an inorganic chemical option for lice control. Lime-sulfur may cause the animal irritation, discomfort or blistering, but it rarely causes death. If overexposure is suspected, bathe the animal to remove any residues and rinse repeatedly with clean water.

**8. Mineral oil.** Mineral oil is useful as a barrier against biting flies in ears of horses. It is also a diluent in some ear mite treatments that contain carbaryl.

**9. Amitraz.** Amitraz is a formamidine chemical with insecticidal and acaricidal properties.

**10. Insect growth regulators and hormone mimics.** This class of insecticides prevents immature insects from developing to the adult stage. Methoprene is formulated as a spray for flea control (eggs on animals, larvae in the environment). These chemicals simulate the activity of juvenile hormone, the hormone in insects that maintains immature characteristics in insects.

**11. Ivermectins.** The ivermectin/avermectin group of insecticides are labeled as drugs, and they often come into use for pest control on animals. Because they are drugs, most of them must be obtained and administered by a veterinarian for companion animal use. There are some over-the-counter formulations for horses available.

## FORMULATIONS USED TO MANAGE ANIMAL PESTS

It is important to choose the formulation that is best for a particular job based on its effectiveness, cost, practicality, and relative safety to you, the animal being treated and the environment.

Insecticide and acaricide formulations vary widely and must be chosen to fit the particular situation. A high-pressure hydraulic sprayer is inappropriate for applying a flea shampoo to a sheep, to give one extreme example. Under certain conditions, the application method requires a particular formulation. Sometimes the formulation and application method are described by the same word (e.g., shampoo). Formulations used for animal pest management include:

1. **Ready to use (RTU).** Ready-to-use formulations require no mixing or combining with other ingredients or diluents. They usually come in a container that serves as the application device, such as an aerosol can, pour-on bottle, roll-on, spot-on or spray bottle. These formulations tend to be the most expensive options because they are convenient and packaged for application. Because of their convenience and effectiveness, these formulations are being used instead of spray treatments to various sized animals. Ready-to-use products may include ointments or gels that help prevent fly bites.



2. **Wettable powders (WP).** Wettable powders must be mixed with water before application. They are concentrates in solid, powdered form and can be sprayed after mixing.

3. **Emulsifiable concentrates (EC).** Emulsifiable concentrates are liquids that must be mixed with water before application. They can be sprayed after mixing or sponged on the animal.

4. **Shampoo.** A shampoo is a formulation of insecticide and other ingredients that is applied

to an animal's wet haircoat and worked into a lather. Label directions may indicate a length of time that the shampoo must remain on the animal to achieve effective pest control before being thoroughly rinsed. Shampoos should be pH balanced and labeled for use on the pet to be treated. Industrial shampoos and dish detergents are not acceptable products for use on small animals. Exercise all caution when applying pesticide products to debilitated animals (animals weakened by injury, illness or some other stress). These animals should be referred to a veterinarian for close observation during and after application.

5. **Dust.** A dust is a ready-to-use dry formulation. Protect the animal's and the applicator's eyes from the dust. Applicators must wear appropriate personal protective equipment to protect exposed skin, the respiratory tract and eyes.

6. **Feed additive or bolus.** These formulations are mixed into salt blocks, with feed or, in the case of a bolus, fed directly to an animal.



Some insecticides are formulated into salt blocks.

7. **Ear tags, plastic strips and medallions.** Some insecticides and acaricides are formulated with plastics, such as ear tags and medallions, that are fixed to an animal and left attached for a time. Plastic straps, for instance, containing an insecticide can be fixed to horse halters for biting fly control. In these formulations, the insecticide moves from the plastic to the hair or coat of the animal.

8. **Pastes, liquids, powders, tablets/pellets and injectables.** These formulations are given orally or injected into animals to control internal parasites. Some products have restrictions, are regulated as drugs by the FDA, and may be purchased and administered only by licensed veterinarians.

9. **Baits.** Baits are either commercially prepared as dry granules or made as mixes of insecticides, sweeteners and water, as discussed in "Methods of Application" below.

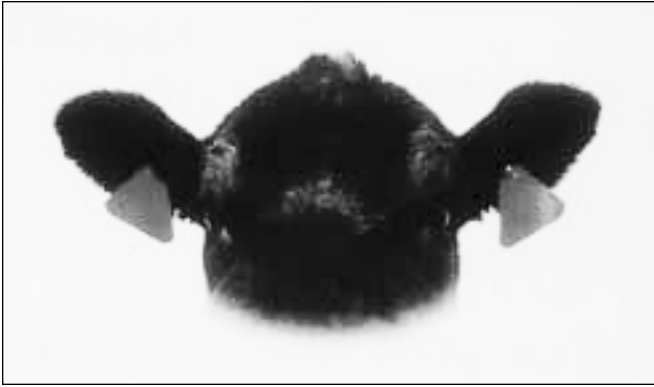

Some pesticides are formulated into plastic ear tags that are attached to the animal. The pesticide in this formulation moves from the plastic to the hair or coat of the animal.

## METHODS OF APPLICATION AND APPLICATION EQUIPMENT

The methods of application of insecticides/acaricides to animals or the animals' environment depend on the target pest, the formulation chosen and the number of animals or size of area to be treated. Sometimes the limiting factor will be the availability of application equipment or suitable facilities and helpers. For example, ear tags must be applied to individual cattle while they are in a head chute (used to isolate and immobilize the head temporarily). Applicators must wear all the protective equipment required on the pesticide label. Labels list minimum requirements. The applicator should use common sense and protect body areas that may be at risk of exposure. Waterproof aprons, gloves, boots and goggles are always a wise choice.

On premises, feedlots, housing barns, corrals, milk parlors, manure piles, poultry houses and other animal agricultural environments, several different methods of applying insecticides may be



Always wear the appropriate personal protection equipment when making a pesticide application.

appropriate. Many involve using spray equipment or specialized tools for handling animals.

## Dipping Vats

Dips are a method of applying insecticides to animals. Dipping vats are large tanks (vats) of liquid pesticide solutions used to treat livestock for external parasites. Portable dipping vats are usually trailer-mounted tanks with a set of folding ramps and railings. Livestock animals may be drawn through or placed in a vat of insecticide diluted to the correct label rate for the given animal size and species, and immersed to wet the entire body. Dips have been commonly used for sheep and cattle.

Dips may also be pour-on products that do not require total immersion of the animal. The product is poured on a specific region of the animal, such as along the backbone. Pour-ons are taking place of the dipping vat method of application because of convenience, lower worker exposure and the ability to treat the animal at the same time it is being vaccinated or handled for other reasons.

The person dipping the animal should wear a water- and chemical-proof apron and gloves. As noted in Chapter 6, Pesticides and Human Health, a human's groin area is the most absorptive part of the body and should be completely protected from pesticide exposure. Goggles can prevent splashing solution from entering the eyes. Always wear the minimum amount of personal protective equipment required on the label. It's okay to wear more.

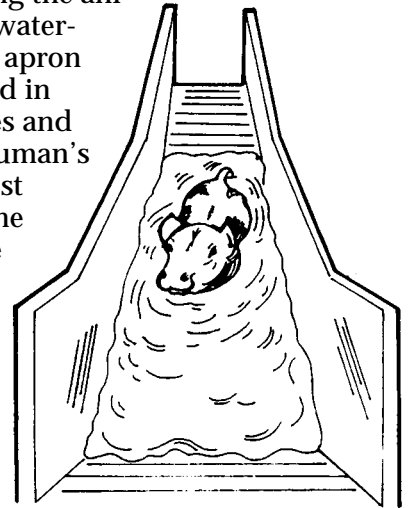

## Spray-dip Machines

Spray-dip machines have been used to treat livestock for external parasites. A spray-dip machine usually consists of a trailer-mounted chute with solid walls and gates at each end. The chute is located above a shallow tank and is equipped with several rows of large nozzles mounted so that they direct the spray mixture to thoroughly cover each animal. A large centrifugal pump supplies the pesticide to the nozzles. Surplus and runoff spray falls back into the tank, where it is filtered and recycled to the nozzles.

## Face and Back Rubbers and Dust Bags



Some pesticides are applied through back rubbers. When the animal rubs against the apparatus the pesticide is transferred to their hair coat.

Some insecticides are applied to livestock for control of external parasites by self-applier devices such as face and back rubbers, cables, ropes and dust bags. Back rubbers, cables and ropes are soaked with insecticide mixed with oil and hung over entrances and exits where the animals must pass. When the animal rubs against the device, the pesticide is transferred to the animal's face, back, sides or legs.

Dust bags filled with dust formulations are hung in similar areas for direct contact with passing animals. Animals can be dusted with the use of the shaker in which the product is packaged. The eyes of the animal and the applicator should be protected from dusts.

## Dust Boxes

Dust boxes are used mainly in raised wire battery-type cages for laying hens or other poultry. These boxes contain a pesticide dust used to control poultry pests, usually mites. Birds wallow in the boxes and pick up the dust on their feathers and skin. Dust boxes may also be used when 20 to 30 birds are in pens on the floor.

## Bait Application Equipment

**Bait stations** hold pesticide-treated food that attracts target pests. They are used for insect control around poultry and livestock housing and for vertebrate control around crops, commodities and agricultural buildings.

An insecticidal **bait** can be purchased ready to use (generally dry, as granules) or can be mixed. Baits can be established at bait stations that lure the pest toward the insecticide source. Some fly baits contain attractants to draw flies in, such as

muscamone. Some fly baits are made by mixing sugar, corn syrup or molasses with water and insecticide and then applied as a slurry with a brush to surfaces in confined settings. Caution: Do not apply this sweet mixture where animals can lick it from treated surfaces. This includes companion animals that may frequent the same areas.

## Applications to the Animal's Surroundings

A **premise spray** is an insecticide application that will persist on the surfaces in an animal's living area for a period of time. The length of residual depends on the insecticide used rather than the method of application. Pest insects, such as filth flies or fleas, contact these surfaces, encounter the insecticide and die. The spray is intended to offer a few days to a few weeks of control. Remove all livestock before applying a residual spray. Avoid exposing hay bales or other feed to pesticides and cover all drinking cups. Do not apply a residual spray in a milkroom.

An **area spray** or **space spray** does not involve an insecticide with long residual qualities. Instead, the spray, aerosol or fog kills the insects in the area at the time of the application. Thus, a space spray is much more temporary than a premise spray.

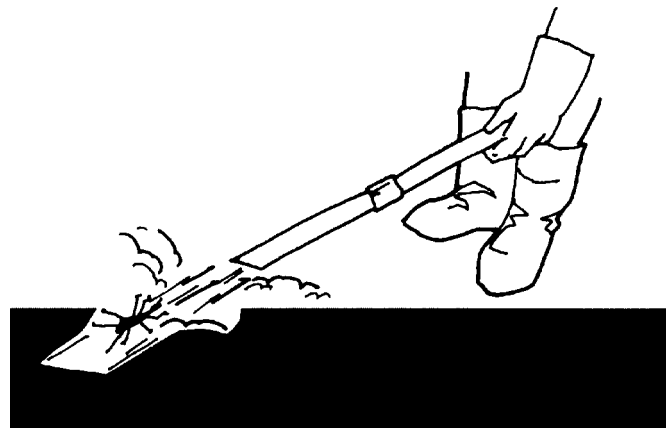

A space spray may involve **ultra-low volume** equipment—small droplets of insecticide are sprayed at a low rate of application into the space. An example would be the use of a fogger in a milking parlor.

Hand-held, electrically operated mist foggers are satisfactory for space applications of insecticides. They are used primarily for fly control (knockdown). Mist foggers produce a coarse mist, deliver 4 to 5 gallons of spray mixture per hour and project a horizontal airstream 15 to 20 feet.

These sprayers are not to be confused with thermal foggers that generate an insecticidal smoke by heating the spray mixture.

Pesticide dosage depends upon the length of time the spray mist is directed toward the animal or area. To calibrate a fogger, first determine the maximum number of ounces of insecticide released per minute then calculate the time in seconds necessary to apply the proper dosage.

In general, use and care for a mist foggers as you would a sprayer. They do require several special precautions, however:

- Be sure that the pesticides used in the aerosol and fog generators are registered for that use.
- Keep the pesticides on the target.
- Because aerosol and fog formulations are easily affected by weather conditions during application, follow special use instructions.
- The operator, other people and animals should stay out of the fog or smoke cloud.

Applying insecticides or acaricides onto animals can be done in a variety of ways. Coarse sprays are applied directly to animals. With hand-pumped or mechanically pressurized equipment, a coarse spray of the label rate of insecticide is applied to the animals. Certain coarse sprays, for example those used for control of mange mites on swine or lice on cattle, must have sufficient pressure to thoroughly penetrate the hair and wet the skin.

## Hand Sprayers

Hand sprayers are often used to apply small quantities of pesticides. They can be used in structures or outside for spot treatments or in hard-to-reach areas. Most operate on compressed air supplied by a hand pump.

**Compressed air sprayer** — This is usually a hand-carried sprayer that operates under pressure created by a self-contained manual pump. The air in the tank is compressed by the pump. The compressed air forces liquid pesticide through the hose and nozzle whenever the control valve is opened. Capacity is usually 1/2 gallon to 3 gallons.

**Bucket or trombone sprayer** — These sprayers involve a double-action hydraulic pump operated with a push-pull motion. The pesticide is sucked into the cylinder and pushed out through the hose and nozzle with the return stroke. Pressures up to 150 psi can be generated. The separate tank often consists of a bucket with a capacity of 5 gallons or less.

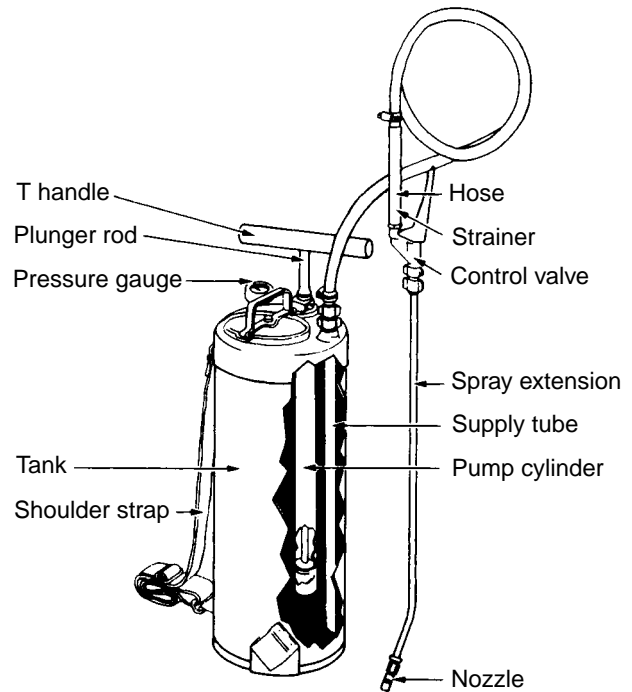

Hand Can Sprayer

**Backpack (knapsack) sprayer** — One type of backpack sprayer is a compressed air sprayer with a harness that allows it to be carried on the operator's back. Some of these sprayers can generate pressures of 100 pounds per square inch (psi) or more. Capacity of these types of backpack sprayers is usually 5 gallons or less.

**Wheelbarrow sprayer** — Wheelbarrow sprayers are similar to backpack sprayers but have a larger tank and longer hose line. The tank is mounted on a wheeled cart for easy transport. The capacity of these sprayers is usually less than 25 gallons.

## Small Motorized Sprayers

Some small sprayers have all the components of larger field sprayers but usually are not self-propelled. They may be mounted on wheels so they can be pulled manually, mounted on a small trailer for pulling behind a small tractor, or skid-mounted for carrying on a small truck. They may be low-pressure or high-pressure, according to the pump and other components with which they are equipped. Standard equipment includes a hose and an adjustable nozzle on a handgun. Some models have multi-nozzle booms.

### Advantages:

- Larger capacity than hand sprayers.
- Low- and high-pressure capability.
- Built-in hydraulic agitation.
- Small enough for limited spaces.

### Limitations:

- Not suitable for large jobs.

**Estate sprayers** — These sprayers are mounted on a two-wheel cart with handles for pushing. Trailer hitches are available for towing the units. Spray material is hydraulically agitated. Some models have 15- to 30-gallon tanks. Pumps deliver 1 1/2 to 3 gallons per minute at pressures up to 250 psi. Larger models have 50-gallon tanks and pumps that deliver 3 to 4 gallons per minute at pressures up to 400 psi. Power is supplied by an air-cooled engine of up to 5 horsepower.

**Power backpack sprayer** — This backpack-type sprayer has a small gasoline powered engine. The engine drives the pump, which forces the liquid pesticide from the tank through a hose and one or more nozzles. The engine also drives air blowers, which help propel the spray droplets. This model can generate high pressure and is best suited for low-volume applications of dilute or concentrated pesticide.

**Power wheelbarrow sprayer** — This sprayer, like the manually operated wheelbarrow sprayer, has a tank mounted on a wheel for easy transport. It may deliver up to 3 gallons per minute and can develop pressures up to 250 psi. The 1 1/2 to 3-horsepower engine is usually air-cooled. The tank size ranges from 12 to 18 gallons. The spray mixture may be either mechanically or hydraulically agitated.

## Large Power-driven Sprayers (High Pressure)

These sprayers are used to spray through dense foliage or thick animal hair and into areas where high-pressure sprays are necessary for adequate penetration and reach. Often called hydraulic sprayers, they are equipped to deliver large volumes of spray — usually 20 to 500 gallons per acre — under pressures ranging from 150 to 400 psi or more. Piston pumps are used and provide outputs up to 60 gallons or more per minute. Large tanks (500 to 1,000 gallons) are required because of the high application rate per area. Mechanical agitators are usually standard equipment, but hydraulic agitators may be used. High-pressure sprayers may be equipped with a hose and single handgun nozzle for use in spraying animals.

### Advantages:

- Provide good penetration and coverage of animal hair.
- Usually well built and long lasting if given proper care.

### Limitations:

- Large amounts of water, power and fuel needed.
- High pressure may produce fine droplets that drift easily.

## Pour-ons and Spot-ons

Pour-ons and spot-ons are high-concentrate, low-volume formulations applied directly to animals. They offer a quick and simple method of applying insecticides to livestock. The solutions, either an oil or emulsion formulation, are applied with a calibrated dipper along the back of the animal at an even rate. Pour-ons were originally developed for application of systemic insecticides for cattle grub control but are being used for some non-systemic formulations. Because of convenience, reduced applicator exposure and their efficacy, these types of applications are the becoming the most frequently used application method, replacing the dipping vat and spraying methods.

Like the pour-on method, spot-ons allow for the direct application of a measured amount of insecticide to the back of the animal. Spot-ons are applied as concentrates so considerably less material is needed. Because of the toxicity of the products, spot-ons are typically applied by a veterinarian. These products may require that the animal be completely dried after application before it contacts humans or other animals.

**Wipes** are also used as direct applications to animals—cloths or sponges are saturated with the pesticide and used to wipe the animal. With pour-ons, spot-ons and wipes, the rate of application is determined by the size and weight of the animal.



The ease of using pour-on formulations is contributing to this becoming the most common application technique.



**Ear tags, plastic strips, collars and medallions**, though technically formulations as described above, are also methods of application. These formulations come ready to use and are applied by fastening them to the animal or, in the case of plastic strips, in the animals environment. They offer long-term release of insecticide or acaricide onto the animal.

**Feeding insecticides to animals** can be accomplished with feed additives or boluses, salt blocks, or drugs prescribed by or obtained from veterinarians. Of course, only those insecticides labeled for oral delivery can be provided in this manner. Some of the insecticides control pests on the animal while others are intended to pass through the digestive systems of the animal to be deposited in manure for fly maggot control.

## PESTICIDE USE AROUND ANIMALS

Pesticide use on animals or in their environment must be done with the safety of the animals and the applicator in mind. Remember that insecticides and acaricides are toxic not only to the target pest but also to the animals at certain doses. Thus, the dose-response relationship of the insecticide and the targeted animal must be considered. The accurate weight of the animal must be determined to dilute and apply the appropriate rate of pesticide.

Many insecticides are labeled with restrictions and are not to be used on animals of certain ages (especially young ones), in certain reproductive states (pregnancy, nursing), or on certain breeds. Also, use extreme caution or avoid using pesticides on animals just before or just after surgery. The product may interact with the anesthesia.

Apply all insecticides with extreme care. Never apply insecticides to the eyes, nostrils or mouth. When treating animals using a spray, the applicator should wear appropriate protective gear and shield his/her eyes and those of the animal. It is standard practice to apply an ophthalmic (eye) ointment to protect small animals' eyes before dipping, spraying or shampooing. Ointments must be labelled for use in the eye. Petroleum jellies are not an acceptable substitute for ophthalmic ointment. Be sure not to contaminate ointments. Handle carefully and wash your hands between animal treatments.

Insecticides must be applied at the rates and with the application methods described on the label. Labels also usually state to avoid testicle and vulva areas as well as mammary gland areas if the animal is nursing young.

When applying certain insecticides or acaricides on animals, the intent is to create a residual of systemic insecticide in the body tissues of the animal. These insecticides are used in ways that do not differ greatly from the way drugs are used for animal health. In such cases, there may be dose limits established in relation to the weight of the animal. Thus, only a certain amount of insecticide per unit of body weight can be applied at any one time. Accurately determining the animal's body weight is critical for issuing the correct dosage.

When using systemic insecticides or some other insecticides on animals used for meat or dairy products, restrictions often apply with regard to when slaughtering can occur or how long dairy animals should be held from milking. These restrictions are called treatment-slaughter intervals and milk withholding times. These restrictions are listed on the label. No residual insecticide should occur in meat or milk when these label restrictions are followed.

Many kinds of pesticides are commercially available. Though different products may have the same active ingredient, the formulations can vary greatly. The result may be that one product is safe for animal applications and others are deadly. **Use only products specifically labeled for use on animals or in animal surroundings.** Consult with experts such as veterinarians, licensed veterinary technicians, Extension specialists or product representatives for help in selecting the best product for your situation. The experts can provide you with information to help make your decision and support your action in the most economical manner. When selecting an insecticide, the label is a primary source of information. Labels often include package inserts. If the label does not allow the use or method of application you intend to use on the animal, then that insecticide formulation cannot be used. When several product choices are available, consider the type of and percent of active ingredient, formulation, equipment required to make the application, any treatment-slaughter or milk withholding intervals and requirements for retreatment.

In general, observe the following guidelines for insecticide use on or around animals:

1. Use only products labeled for use on animals or in animal environments.
2. Do not exceed label dosages; measure carefully and know the animals's exact weight.
3. Read labels before using and follow all instructions.
4. Provide adequate ventilation while using pesticides (remove animals from buildings if it is an area or premise spray).

5. Prevent drift or drainage to adjacent cropland, yards, woodlots, lakes or ponds. (Some insecticides may severely harm fish and wildlife.)
6. Avoid treatment of animals that are sick, overheated or stressed (such as after shipping, surgery or heartworm treatment, or recently weaned).
7. If available, use a dust formulation instead of sprays on outdoor animals on cold winter days.
8. Avoid contaminating feed (feeders and/or feed in storage) and water (including waterers, wells and reservoirs). See Chapter 8, Safe Pesticide Handling, in the Core manual, E-2195.
9. Use all appropriate personal protective equipment during applications of any pesticide.
10. Do not add new insecticides to old, previously used dipping water. Start with fresh water.
11. Avoid using pesticides when an animal has been, will be or is anesthetized.
12. Keep records of pesticide applications. See Chapter two, Laws and Regulations, in the Core manual, E-2195.
13. Always store and dispose of pesticide containers according to label directions.

## COMPATIBILITY of PESTICIDES

In some situations, applicators may attempt to manage more than one pest with a single application by combining pesticides. Such a practice can create problems, sometimes more serious and costly than applying the chemicals alone. Product mixing requires extensive knowledge of pesticide formulations, timing of application and application techniques.

The important issue is to determine the compatibility of the products involved. In simple terms, we are concerned about whether the mixtures can be used in combination without reducing the safety and effectiveness of the compounds. Before combining any pesticides, check labels, product information sheets, company representatives or Extension agents for information on compatibility of the products in question.

Below are important areas of incompatibility to consider before attempting to mix products.

### Host Tolerance

As mentioned, problems can arise when more than one organophosphate is applied to an animal at any one time, or when a residual is still present from a previously applied dose. Never use more than one OP insecticide on an animal. The combined effects of the OPs may cause irre-

versible damage to the animal or even kill it. Also, some animals are more sensitive to certain products than others. Always read the label before applying a pesticide on an animal.

### Physical Incompatibility

Physical incompatibility occurs when two or more pesticides are mixed together and the result is an unsprayable mixture because of excessive foaming, curdling or a gummy deposit. Hard water and cold water also can cause some physical incompatibilities.

### Chemical Incompatibility

This type of incompatibility occurs when mixing pesticides reduces or destroys the effectiveness of one or all of the compounds. This happens frequently when materials with a high pH are added to the mixture. Chemical incompatibility is not evident in the spray tank but becomes apparent when the application fails to control the target pest adequately.

### Timing Incompatibility

Pesticides must be applied when the pest is at a vulnerable stage of development. With many insects, diseases or weeds, this may be a relatively short period. Timing is important when using two or more chemicals to manage more than one pest. Failing to apply the mixture at the correct time in the pests' life cycles renders the mixture ineffective.

This has been a brief summary of pesticide compatibility problems. Remember, never assume that pesticides can be mixed together unless the combination is specifically indicated on a product label. If recommendations for use are not given on the label, the products in the mix must be applied at a rate not to exceed the label directions for use of any component product applied alone for the same purpose. Many product labels have toll-free numbers. Call with any questions you may have before using a product.

---



## Chapter 2 – Review Questions

**Write the answers to the following questions and then check your answers with those in the back of this manual.**

1. A pesticide is a chemical that:
  - a. manages only insects and vertebrates.
  - b. directly controls pest populations.
  - c. prevents or reduces pest damage.
  - d. only a certified applicator may apply.
  - e. b and c.
2. Pesticides with chlorinated hydrocarbon chemistry are not recommended for use on animals. (True or False)
3. If a product label bears chemical names containing “phosphoro” and recommends the use of atropine plus 2-PAM as an antidote for poisoning, you can assume the product is a(n):
  - a. Chlorinated hydrocarbon.
  - b. Organophosphate.
  - c. Pyrethroid.
  - d. Carbamate.
  - e. Insect growth regulator.
4. What are the symptoms that an animal may exhibit as a result of overexposure to an organophosphate pesticide?
5. Which two types of pesticide chemistry inhibit cholinesterase? What types of pests do these pesticides control?
6. If an animal is overexposed, it can be killed by pesticide products even though the products are labeled for use on animals. (True or False)
7. If an animal is dermally overexposed to a synthetic pyrethroid, what action should you take?
  - a. Bathe the animal with mild detergent and rinse it repeatedly.
  - b. Give the animal atropine.
  - c. Give the animal atropine plus 2-PAM.
  - d. Keep it cool and give it water.
8. Protectants are pesticides applied to manage pests by rendering them incapable of normal reproduction. (True or False)
9. What might you use for protection against biting flies on the ears of horses that can also serve as a diluent for ear mite treatments?
  - a. Lime sulfur
  - b. Amitraz
  - c. Ivermectin
  - d. Mineral oil

10. Which of the following are synthetic organic pesticides?
- Chlorinated hydrocarbons.
  - Organophosphates.
  - Carbamates.
  - Synthetic pyrethroids.
  - All of the above.
11. Some insecticides are formulated as feed additives and are given to the animal as part of their food rations. (True or False)
12. Explain the difference between a premise spray and an area or space spray.
13. Which of the following are self-application techniques used for livestock treatments?
- Back rubbers.
  - Dips.
  - Ear tags.
  - Spot-ons.
14. When choosing among several insecticide products, what are some of the things that must be considered?
15. List three types of pesticide incompatibility, and give a brief definition of each.
- - 
  -

---

# CHAPTER 3

## MITES AND TICKS

### LEARNING OBJECTIVES

After you finish studying this chapter, you should be able to:

- Describe how mites and ticks differ from insects.
- Understand the ways that mites can negatively affect animal health.
- Explain what mange is and how it occurs.
- Explain the generalized life cycle of mites.
- List several mites that affect agricultural animals.
- Know where mites and ticks are typically found on agricultural animal's bodies.
- Describe integrated programs for controlling mites and ticks.
- Understand the basic life cycles of ticks.
- Describe the appearance of a tick.
- List some of the important tick pests of animals.

---

Chapter one of this manual gives specific information on biology and identification of pests including insects and other arthropods. Review that information to learn arthropod external characteristics, life cycles, and ways that they cause damage and act as pests.

### MITES

There are more than 200 families of mites and many thousands of species. Most mites are free-living and feed on plant juices or prey upon other arthropods. Some mites have evolved to become important ectoparasitic pests of animals. Some species of mites have even become endoparasites, invading the ears, bronchi and lungs, nose and other tissues of animals. More than 50 species of mites live on or in the bodies of domestic animals.

In general, mites can affect the health of animals in four ways:

- Damage tissues and cause dermatitis.
- Cause blood or body fluid loss.
- Cause allergic reactions.
- Create conditions for secondary bacterial infection.

Mites are tiny arthropods, usually less than 1 mm in size, and can be difficult to see and identify without the aid of a strong microscope or at least a

hand lens. Figure 3.1 shows a schematic view of the general anatomy of a mite. Note that the feeding apparatus of a mite is called the **hypostome**. It contains the **chelicerae** and the paired **palpi** (singular, palpus). The four pairs of legs are segmented, and each joins the body at the **coxa**.

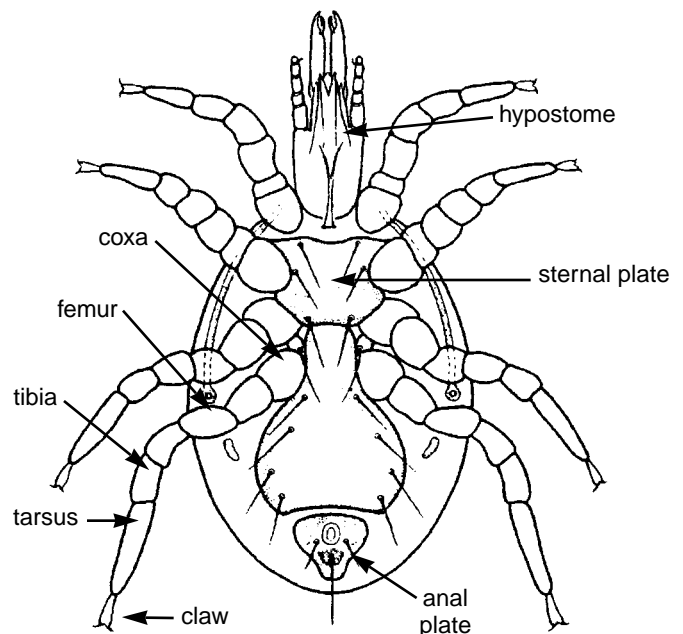

**Figure 3.1 General anatomy of a mite.**  
Source: Centers for Disease Control.

The body of a mite consists of two major units – the cephalothorax and abdomen. The body is made of various hard plates of cuticle connected together by softer cuticle.

Mites breathe directly through their cuticle, in the smaller species, or through pores in the cuticle (called stigmata), which are connected to internal air tubes. Although the figure does not show it, mites are often rather hairy looking because of the presence of spines. Mites can vary greatly from this generalized body design, as figures and descriptions given below demonstrate.

The generalized veterinary term for an infestation of mites in an animal is **acariasis** (pronounced ack-uh-RYE-uh-sis). **Mange** or **scabies** is one of the most common problems that mites cause in animals. Mange is a deterioration of the skin's condition (pathology), leading to hair or feather loss, a rash, skin discoloration (inflammation) and, in severe cases, lethargy and weakness. The USDA defines scabies and mange as it relates to cattle as "any skin condition of man or animals associated with a mite; scabies is a particularly serious, debilitating, reportable mange condition." The nature of the skin effects are determined by the location of the mites on the animal's body.

## Life Cycle

The generalized life cycle of mites can be described as follows. Mites mate and the females lay eggs. The eggs hatch and six-legged **larvae** emerge. These larvae feed and molt to the eight-legged **nymph** stage. Later, after feeding, the nymphs molt and become **adult male** or **female** mites. This entire life cycle can take as little as eight days to as long as four weeks, depending on the species of mite, and the temperature and humidity.

Some mites transmit disease causing microorganisms through biting. Other mites are **intermediate hosts** of tapeworm parasites that infect cattle and sheep. An intermediate host is an animal that harbors the asexual or immature stages of a parasite which do not mature until transferred to the next host. For example, if sheep eat the intermediate hosts containing these parasite stages, they can become infected with the parasite. This is in contrast to the definitive host of the parasite which is the host in which the parasite undergoes sexual reproduction; there is no intermediate host required for progression to maturity.

## Mite Pests of Animals

Table 3.1 lists the common mite pests of domestic animals, both livestock and companion ani-

mals. In general, the important mites that can be controlled with insecticides (or more properly, **miticides**) include the following groups:

- **Burrowing mange mites** (including the sarcoptic mange mites, notoedric mange mites and knemidocoptic mange mites).
- **Non-burrowing mange mites** (the psoroptid mange mites).
- **Ear mites** (psoroptid ear mites and otodectic ear mites).
- **Demodectic or hair follicle mites.**
- **Fur mites** (cat, dog and rabbit fur mites).
- **Chicken roost mite.**
- **Northern fowl mite.**

These mites all cause adverse skin conditions on their host animals.

The mites that cause scabies in cattle can create severe injury to skin. Infestations are contagious and animals are required by law to be quarantined and treated.

## Burrowing Mange Mites

Sarcoptic mange mites cause sarcoptic mange. Sarcoptic mange mites belong to one species, *Sarcoptes scabiei*, with host-adapted varieties (species-specific) that do not cross-infect other animals. This means they usually infect only one species of animal host. There are at least seven varieties infecting horse, cattle, sheep, goat, swine, dog and fox. Cats, rabbits and fowl are not sarcoptic mange mite hosts.

The life cycle of sarcoptic mange mites is similar on different host animals. The mated female mites burrow deep into the skin and form a tunnel over an inch long where she feeds on lymph fluid (a clear body fluid) by piercing the skin. She lays 40 to 50 eggs in the burrow and then dies. Tiny, six-legged larvae hatch from the eggs, leave the female's burrow and wander on the animal's body. The larvae form new pocket-burrows in the skin, where they feed and molt to two succeeding nymphal stages. The nymphs may also move about and make new tunnels. Nymphs molt and become adult males or females, which mate. Figure 3.2 shows a sarcoptic mange mite life cycle.

Sarcoptic mange mites, because of their burrowing behavior and feeding, cause intense itching and dermatitis. Affected animals may scratch so heavily that liquid exudes from the affected skin, causing skin crusts, and skin cracking and thickening. Secondary infection is common in scratched areas.

**Table 3.1 Common ectoparasitic mite pests affecting animal health in the U.S.**

<b>Host Animal</b>	<b>Common Name</b>	<b>Scientific Name</b>	<b>Tissue Affected</b>	<b>Mite Activity</b>	<b>Pathological Condition</b>
<b>Cattle</b>	Follicle mite	<i>Demodex bovis</i>	hair follicles	live in hair follicles, feed on sebum	demodetic mange
	Sarcoptic mange mite	<i>Sarcoptes scabiei</i> var. <i>bovis</i>	skin	mites dig tunnels, live in skin	sarcoptic mange
	Chorioptic mange mite	<i>Chorioptes bovis</i>	skin	live on skin or under scabs	leg, foot and tail mange
	Psoroptic mange mite	<i>Psoroptes ovis</i>	skin	live on skin or under scabs	scabs, scaly mange
<b>Swine</b>	Follicle mite	<i>Demodex phylloides</i>	hair follicles	live in hair follicles, feed on sebum	demodetic mange
	Sarcoptic mange mite	<i>Sarcoptes scabiei</i> var. <i>suis</i>	skin	mites dig tunnels, live in skin	sarcoptic mange
<b>Sheep</b>	Follicle mite	<i>Demodex ovis</i>	hair follicles	live in hair follicles, feed on sebum	demodetic mange
	Sarcoptic mange mite	<i>Sarcoptes scabiei</i> var. <i>ovis</i>	skin	mites dig tunnels, live in skin	sarcoptic mange
	Chorioptic mange mite	<i>Chorioptes bovis</i>	skin	live on skin or under scabs	leg, foot and tail mange
	Psoroptic mange mite	<i>Psoroptes ovis</i>	skin	live on skin or under scabs	scabs, scaly mange
	Itch mite	<i>Psorergates ovis</i>	hair follicles	live on skin	scaly mange
<b>Goat</b>	Follicle mite	<i>Demodex caprae</i>	hair follicles	live in hair follicles, feed on sebum	demodetic mange
	Sarcoptic mange mite	<i>Sarcoptes scabiei</i> var. <i>caprae</i>	skin	mites dig tunnels, live in skin	sarcoptic mange
	Ear mite	<i>Psoroptes cuniculi</i>	ear canal	live on skin or under scabs	psoroptic ear mange
	Chorioptic mange mite	<i>Chorioptes bovis</i>	skin	live on skin or under scabs	leg, foot and tail mange
<b>Horse</b>	Follicle mite	<i>Demodex equi</i>	hair follicles	live in hair follicles and feed on sebum	demodetic mange
	Sarcoptic mange mite	<i>Sarcoptes scabiei</i> var. <i>equi</i>	skin	mites dig tunnels, live in skin	scabies, mange
	Chorioptic mange mite	<i>Chorioptes bovis</i>	skin	live on skin or under scabs	leg, foot and tail mange

*Continued on next page*

**Table 3.1 Common ectoparasitic mite pests affecting animal health in the U.S., *Continued***

<b>Host Animal</b>	<b>Common Name</b>	<b>Scientific Name</b>	<b>Tissue Affected</b>	<b>Mite Activity</b>	<b>Pathological Condition</b>
<b>Cat</b>	Follicle mite	<i>Demodex cati</i>	hair follicles	live in hair follicles, feed on sebum	demodetic mange
	Notoedric scabies mite	<i>Notoedres cati</i>	skin	mites dig tunnels, live in skin	notoedric scabies, mange
	Ear mite	<i>Otodectes cynotis</i>	skin surface in ear canal	live in ear canal, feed on skin debris	ear mite infestation
	Cat fur mite	<i>Cheyletiella blakei</i>	skin	punctures skin & sucks lymph	scaly dermatitis
<b>Dog</b>	Follicle mite	<i>Demodex canis</i>	hair follicles	live in hair follicles, feed on sebum	demodetic mange
	Sarcoptic mange mite	<i>Sarcoptes scabiei var. canis</i>	skin	mites dig tunnels, live in skin	scabies, mange
	Ear mite	<i>Otodectes cynotis</i>	skin surface in ear canal	live in ear canal, feed on skin debris	ear mite infestation
	Dog fur mite	<i>Cheyletiella parasitivorax</i>	skin	punctures skin & sucks lymph	scaly dermatitis
<b>Rabbit</b>	Notoedric scabies mite	<i>Notoedres cati</i>	skin	mites dig tunnels, live in skin	notoedric scabies, mange
	Ear mite	<i>Psoroptes cuniculi</i>	ear canal	live in skin or under scabs	psoroptic ear mange
	Rabbit fur mite	<i>Cheyletiella yasguri*</i>	skin	punctures skin and sucks lymph	scaly dermatitis
<b>Chicken, turkey, pheasant, caged birds</b>	Chicken mite	<i>Dermanyssus gallinae</i>	roosts (free-living)	feeds on blood through skin	dermatitis, blood loss
	Northern fowl mite	<i>Ornithonyssus sylviarum</i>	skin,, feathers	feeds on blood, through skin	dermatitis, blood loss
	Scaly-leg mite	<i>Knemidokoptes mutans</i>	skin	burrow beneath epidermal scales	scaly leg lesions
	Depluming mite	<i>Knemidokoptes laevis var.</i>	base of feathers	burrow beneath epidermal scales	skin irritation, feather loss

Although all parts of an animal's body may be affected, usually the less hairy areas become infested. In swine, the primary infested parts of the body are the neck, shoulder, ear, withers, and back to the tail. Sarcoptic mange in horses usually occurs on the chest and at the base of the tail. In dogs, sarcoptic mange occurs on the face, but can spread to other parts of the body.

Detecting and identifying sarcoptic mange mites can be difficult because the mites live in the skin burrows. Deep skin scrapings that cause blood to ooze from the scraping are required to scoop mites out of the burrows. The scrapings are then examined with a microscope because these mites are too small to be seen with the naked eye. Figure 3.3 shows a sarcoptic mange mite to illus-



trate general features. To properly detect and identify these mites, consult a veterinary dermatologist, parasitologist or entomologist. Although, veterinary manuals contain information on identification and detection, a trained professional can make the best diagnosis.

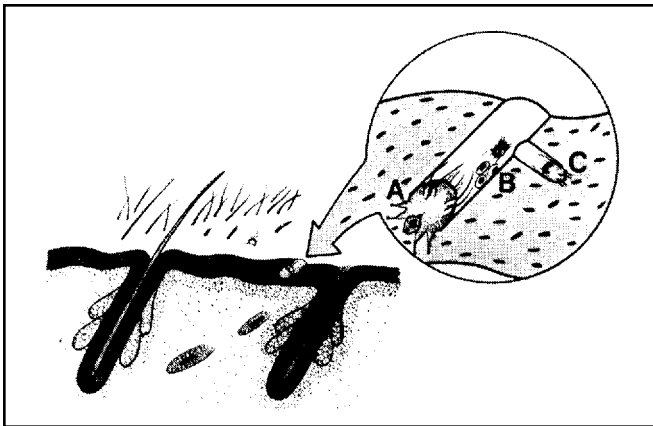

Figure 3.2 “Sarcoptic mange mite life cycle, which is completed in the skin: Adult (A) lays eggs (B), which develop into immature nymph stages (C).

**Notoedric mange mites** are similar to the sarcoptic mange mites in biology, pathology, detection, and identification, except that they are smaller. They occur in cats and rabbits, but also occasionally in dogs. These mites infest skin primarily on the back of the neck, ears, face, and paws, but may cover the whole body, especially in young animals. Detection and identification is done in the same manner as with the sarcoptic mange mites.

The third group of burrowing mange mites affects domesticated fowl, including chickens, turkeys, pheasants, and caged pet birds. This group includes the scaly leg and depluming mites. The scaly-leg mite, *Knemidokoptes mutans*, forms burrows under the epidermal scales on the toes, feet, and legs of birds. The burrowing and feeding activity of the mites causes inflammation, disfiguration of the skin with crusts, scale and scab formation and swollen legs and feet. The skin hardens and exudes fluid. Sometimes, these mites also infest the comb and neck. Heavily infested birds may die because of hypersensitive allergic reactions.

The depluming mite, *Knemidokoptes laevis* var. *gallinae*, usually occurs only on chickens. Rather than infesting the skin of the legs and feet, the depluming mites form burrows at the base of feathers in the skin. When mite burrowing and feeding irritates the birds and they scratch, the feathers fall out and the bird becomes deplumed in the affected areas of the body. All of these mites have similar life cycles and detection methods similar to the other burrowing mange mites.

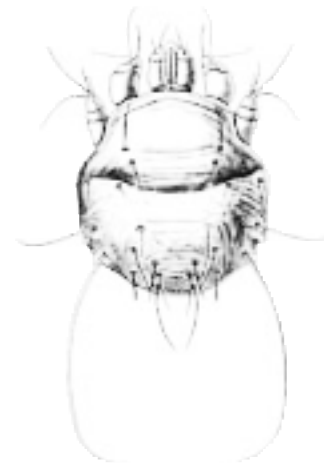

Figure 3.3 Sarcoptic mange mite general features.  
Source: Peter Carrington

## Non-Burrowing Mange Mites

The non-burrowing mange mites, in contrast to the burrowing mange mites discussed above, do not form burrows in the skin. However, they do infest animal skin and cause mange. These mites feed on lymph (clear body fluid) by puncturing the skin, or they feed on skin scales and debris. Mite feeding causes fluid to exude from the skin and form scabs, which turn into yellowish crusts if not treated. The mites live at the edge of these scabs or underneath them. These mites’ life cycle can be as short as nine days.

There are two important species of non-burrowing mange mites. *Psoroptes ovis* infests the skin of horses, cattle and sheep causing infestations commonly called sheep scab or cattle scab. The veterinary term for infestation by these mites is **psoroptic mange**. The entire body may be infested, but usually the hairier areas are affected, particularly the back, shoulders and sides.

The other important species of non-burrowing mange mite is *Chorioptes bovis*, which infests horses, cattle, sheep and goats. The veterinary term for infestation by these mites is **choriopic mange**. Usually, the legs of these animals are affected, causing stamping and leg-biting in horses. In cattle, the mites often infest the base of the tail. Choriopic mange mites appear to mainly feed on epidermal (skin) debris. Yet, infestation by these mites still may lead to mange in some animals. Animals may often be infested with choriopic mange mites but show no mange symptoms. Figure 3.4 shows a choriopic mange mite.

Detecting and identifying non-burrowing mange mites requires skin scrapings by a trained professional. These scrapings do not need to be as deep as those for burrowing mange mites, but a proper diagnosis of burrowing or non-burrowing

mange mites may require a deep scrape and a shallow scrape. Scraped material should be spread or applied onto glass microscope slides and examined under a microscope at high power.



Figure 3.4 Chorioptic mange mite.  
Source: Peter Carrington

## Ear Mites

Ear mites are closely related to the non-burrowing mange mites but they live on the skin of ear canals instead of on the outer skin. There are two species of ear mites of importance. *Otodectes cynotis* causes ear mange and lives in the ears of carnivores including dogs, cats and ferrets. *Psoroptes cuniculi* lives in the ear canals of rabbits, horses, cattle, sheep and goats. It also causes ear mange. The life cycle of these two mites is similar to the non-burrowing mange mites. The swarming, reproduction and feeding activity of these mites causes inflammation and intense itching in the ears of affected animals. Crusts form on the skin. An infested animal will often shake its head, carry the head to the side, scratch the ears and show signs of disequilibrium or dizziness by turning in circles. The ears may exude pus. Sometimes, in cases with extreme infestation and secondary infection, the ear drum perforates, allowing the middle and inner ear to become infected with bacteria.

Detecting and identifying ear mites is accomplished by ear scrapings or sampling with an oil-soaked cotton swab and then examining with a microscope. In some cases, an otoscope (ear examining instrument) may be used to search for mites, but infested animals with sensitive ear canals may not tolerate its use and may need to be restrained. With other animals, examining the ear with an otoscope may reveal mites crawling about in the ear canal. If mites are detected, no ear swabbings are necessary.

## Hair Follicle Mites

Follicle mites are tiny, elongate mites that live in the hair follicles or **sebaceous (oil) glands** associated with hair follicles in mammals. The species of major importance to domesticated animals belong in the genus *Demodex* (see Table 3.1).

Follicle mites are common parasites of cats, dogs, horses and other large animals. In healthy animals, follicle mites do not cause any skin deterioration or mange. Animals with severe demodectic mange generally have immune systems that do not function properly. In weak or diseased animals, two skin conditions can develop. In the scaly skin condition, skin thickens and wrinkles and hair falls out. The skin turns color changing from its normal color to red or bruised-looking. In the pustular skin condition, pimples or pustules filled with pus develop. The pustules can develop into severe abscesses or nodules filled with fluid and pus. This skin condition usually develops after the scaly condition and reflects the development of secondary bacterial infections in the follicles. In both conditions, itching occurs. These skin conditions are collectively called **demodectic mange**.

Heavily infested dogs exhibit demodectic mange on several parts of the body, but particularly on the face and paws. Demodectic mange in dogs is also called **red mange**. Secondary bacterial infection, especially by *Staphylococcus*, as part of the overall mange condition can lead to death in dogs. Social stress may contribute to the onset of mange conditions. In other animals, follicle mite infestation is usually asymptomatic (showing no symptoms). However, in swine and cattle, infestations can result in nodules and abscesses resulting in hide damage. Goats and horses can exhibit mild demodectic mange but generally do not develop abscesses or nodules.

Detecting and identifying follicle mites can be done by a trained professional using a deep skin scrape (as with burrowing mange mites), or by expressing pustules or abscesses and preparing slides for microscopic examination. Identification is quite easy after slides have been prepared. There are no other mites that have the elongated appearance of follicle mites, shown in Figure 3.5.

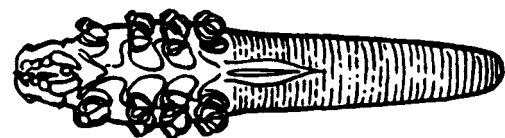

Figure 3.5 Hair follicle mite.

## Other Mites: Chiggers, Chicken and Fowl Mites

Several other kinds of mites bite or infest domesticated animals. Larvae of **chigger mites** normally parasitize wild rodents. The larvae attach to the skin and suck tissue fluids. Larval chiggers seek hosts by clinging to vegetation near ground level and wait for an animal to pass by. Chiggers typically occur in low-lying, humid environments such as stream sides and marsh or lake edges. Pastured cattle or horses may occasionally be bitten by chigger mites in these situations. Chiggers may cause itchy lesions on animals that crust over. They may be found on legs, feet and ears. The larvae attach to the skin and suck tissue fluids.

Diagnosis of chiggers on animals includes the observance of bright orange mites, crusty lesions, skin scrapings, and environmental history of being in woods and fields. Treatment includes dips and shampoos with an insecticidal product according to label directions. Keep animals out of contaminated areas to prevent reinfestation.

Two mites commonly infest poultry. *Dermanyssus gallinae*, the **chicken roost mite** (or just **chicken mite**), infests domesticated fowl as well as wild birds such as pigeons and house sparrows. During the daytime, these mites hide in cracks and crevices in the birds' roosts and in poultry houses. At night, the mites leave their refuge, infest the birds and feed on their blood. Heavy infestations in chicken houses can reduce egg laying, and cause blood loss that may lead to death in chicks and displacement of layers from their nests. In heavily-infested houses, the birds have pale combs and wattles. Birds become droopy and weak and more susceptible to other parasites and to disease.

Chicken mite infestations can be detected by collecting dirt and other material from mite hiding places in the roosts and houses and examining the material for mites. You may see masses of these small mites, their eggs, and silvery skins cast by the immature mites. Chicken mites are more of a warm weather (summer) pest and may go unnoticed unless you examine the birds at night when the mites are blood-feeding.

Sometimes chicken mites leave the nests of pigeons or sparrows and invade houses, biting people. This occurs especially when the adult birds leave their nests after the young have fledged (acquired feathers necessary for flight).

The **northern fowl mite**, *Ornithonyssus sylviarum*, infests poultry and wild birds. Unlike the chicken mite, the northern fowl mite spends most of its time on the host birds, but also occurs

in nests and houses. Northern fowl mites are more of a problem in cool weather (winter), but may be found on birds the year round. Mite populations can rise rapidly after a bird has been infested initially. When conditions are optimal for the mite, newly infested birds may support mite populations in excess of 20,000 per bird within 9 to 10 weeks. Mites do not become established in large numbers on birds until birds reach sexual maturity; birds greater than 40 weeks of age usually do not support many mites. The feathers will darken from the eggs, cast skins, dried blood and excrement of the mites. Scabs may form in the vent area. The mites suck blood and the resultant wounds can develop into dermatitis and become infected with bacteria. Heavy infestations of northern fowl mites are unhealthy for poultry, causing reduced food intake, weight loss, a pale pink comb and decreased resistance to disease and other afflictions. Also, there is a lower egg production in layers. Detection is accomplished by direct examination and handling of the birds and eggs, and skin scraping from potentially infested birds.

The northern fowl mite and the chicken roost mite are similar in appearance, even when viewed with a microscope. Identification should be attempted with help from entomologists or parasitologists.

## Endoparasitic Mites

Some mites occur in the internal organs and tissues of animals, particularly the respiratory passages. These mites are appropriately classified as endoparasites. For example, *Pneumonyssoides caninum* infests the sinuses and nasal passages of dogs. Do not deal with these mites strictly as arthropod pests suitable for control with miticides by a certified applicator, but rather refer to veterinarians for any necessary treatment.

Mites in the family Oribatidae (commonly called **oribatid mites**) are generally free-living and occur in soil. Although these mites are not typically ectoparasitic on domestic animals, some of them are important as intermediate hosts for certain tapeworms (genus *Moniezia*) that infect cattle, sheep and goats. The mites ingest tapeworm eggs found in infected animal feces. Inside the mite, immature stages of the tapeworm (called cysticercoids) develop. Cattle may later ingest the mites as they graze in pasture and become infected with the tapeworms. Environmental control of the oribatid mites to reduce worm load in the pastured animals is not generally recommended.

## **Skin scraping and ear swabbing for mite detection where mange or ear mites are suspected.**

Mites causing mange or infesting the ears may initially be suspected if an animal's behavior or appearance changes to an abnormal condition. Gross changes in coat or skin condition, or excessive licking and scratching can be signs that mites have infested the animal at unhealthy levels.

Detection (or diagnosis) of mite infestations of animal skin and ears can be accomplished by examining the entire body surface using a hand lens. However, mange, ear and fur mites may be more readily and definitively detected by the skin scrapings performed by a professional.

As discussed, skin scraping may be shallow (i.e., not draw blood) or deep (i.e., slightly draw blood) and can reveal non-burrowing, burrowing and hair follicle mites depending upon the depth of the scrape. Veterinarians trained in skin examination and diagnosis of dermatological and ear problems in animals should be consulted for assistance with these detection methods. These experts can help determine if the perceived problem is caused by mite infestation or something else. Be sure that the animal is adequately restrained during these procedures to ensure the safety of the person performing the technique.

## **MANAGEMENT OF MITES ON ANIMALS OR IN ANIMAL ENVIRONMENTS**

Obviously, there are many different species of mites that affect the health of many different kinds of domestic animals. Thus, the measures to control mite problems vary with the species of mite and kind of host animal involved.

The first step in managing mite ectoparasites on livestock is to provide for good herd health because it helps maintain the animals' resistance to mite infestations. Housing, nutrition and sanitary conditions should be at optimal levels. Animals held under crowded conditions, on poor feed rations and in unclean housing are more likely to contract or harbor infestations of mites. Animals in poor health for other reasons also are more susceptible to mite infestations and may be reservoirs of mites, causing infestations of healthy animals. Examine new animal additions to a herd or flock for pests and, if necessary, treat to prevent contamination of animals already present. Quarantining new animal additions is part of good husbandry practices.

Control of mites on animals or in the environment usually requires use of approved pesticides

or drugs. The choice of which pesticide to use, or which drug, varies with the mite that is the pest and the animal infested by the mites. Pesticides that are used to control mites or ticks are called **acaricides**. Note that not all insecticides approved for louse (more than one lice) control on livestock are approved or effective for mange mite control. Consult with your veterinarian.

**Cattle.** The mites on pastured or confined beef and dairy cattle that require control measures are those that cause mange or scabies. These problems usually occur in winter and reach peak outbreaks in winter and spring. Report any infestation of mange or scabies mites in cattle to federal agricultural officials. The presence of a single scabies mite is the infestation level (action threshold) at which animals should be treated. Affected animals should be culled (removed) from the herd and quarantined. Whole herd quarantine and treatment may be required.

For beef cattle infested with scabies mite, the animals twice must be dipped or sprayed in a spray-dip machine at intervals required by the label. There are several approved acaricides for this purpose. Alternatively, cattle may be injected with an ivermectin drug. Non-lactating dairy cattle can be treated similarly, or with a high-pressure spray. In all cases, the applications have slaughter intervals or milk withholding times that must be adhered to.

**Swine.** Producers will need to decide whether to eradicate mange or to control it. Eradication is possible, but expensive, and reinfection may occur. Under the supervision of a veterinarian, injecting all swine on the farm on the same day with ivermectin will eliminate mange infestation. However, if even one animal is missed, it can serve as a source of reinfestation for the entire herd.

Alternately, producers may opt for a program of control that seeks to keep infestation at a very low and tolerable level. Various acaricides can be used effectively in a control program. The frequency of application depends on the initial severity of infestation. Control starts with the breeding herd. Severely affected sows should be culled or injected with ivermectin. The remainder of the breeding herd should be treated thoroughly with a spray-on acaricide either simultaneously for at least three times at weekly intervals, or alternately in segregated groups prior to farrowing. Then a routine program of spraying the sows with a repeat spray in two weeks can be carried out twice a year. If production is in batches, then weaned pigs can be treated when they are moved to the nursery

facility. Treatment at this age and segregation from older animals precludes the necessity of more expensive treatment of older, larger animals in finishing.

Nursery pigs may be treated with spray-ons, ivermectin injection, or ivermectin feed additive. If necessary initially to treat growing, finishing pigs, schedule treatments to prevent conflicts with sales of market animals. Many spray applications have pre-slaughter withholding times and ivermectin must be injected more than 18 days before slaughter.

**Sheep and goats.** Mange mites affecting sheep and goats can be detected by the methods mentioned previously. Mange mites can be controlled on these animals through the use of approved acaricides. Dipping and using pour-ons are the methods of choice for acaricide applications.

**Poultry.** Both the northern fowl mite and the chicken mite are important pests of confined poultry. The best method of northern fowl and chicken mite control is preventing the contact of infested birds with healthy, pest-free birds and keeping the houses clean.

Detecting an initial low mite population that can be controlled effectively and economically is important in a mite-monitoring program. Individuals in flocks should be monitored regularly for mite presence. At least ten randomly selected birds from each cage row (in a caged-layer operations) in the entire house should be monitored weekly. To reveal the mites, examine the vent area under a bright light, and part the feathers. Northern fowl mites congregate on the bird's abdomen or around the vent. The actual decision to treat is influenced by flock age, time of year, and distribution of the infestation in the house. It is usually uneconomical to treat older birds because their mite populations are unlikely to increase. A population build-up is more likely in a young flock. Mite populations can be expected to increase in cooler months and decrease in warmer months. An infestation restricted to one part of a house may not spread, but the infested area must be monitored closely. Detecting mites in broiler-feed operations generally means the entire flock must be treated. Once mites become established on birds, the use of acaricides is an important part of management.

When treatment for mites is necessary, apply the insecticide to the birds in the late afternoon before their eggs have hardened in the oviduct. This reduces the potential for egg cracking and, therefore, lower grading of the egg for market. Chemical control of northern fowl mites in caged-layer operations requires applying the insecticide

directly to the vent region with sufficient pressure (minimum 100 to 125 psi) to penetrate the feathers. The spray will have to be directed upward from beneath the cages to reach the vent. Liquids are preferable to dusts for northern fowl mites. Even though they normally live on the host, northern fowl mites can survive off the host for two to three weeks at room temperature. Therefore, removing birds from an infested house and replacing them two weeks later may not solve the pest problem.

Chicken mites visit the poultry at night to blood-feed and hide in cracks, nests and other protected sites during the day. Thus, sanitation is a very important management method for chicken mite infestations. Acaricide sprays directed into these hiding areas, using liquid formulations, provides the best approach for chemical control of chicken mites. Through the use of premise treatments, chicken mites may be controlled without actually having to treat the chickens.

There are plastic strips impregnated with acaricides that can be placed in the areas where birds nest and congregate. When the birds rub against these strips, the insecticide is transferred to their bodies.

**Horses.** Horses can be infested by mange mites that cause a deterioration of the skin and coat. The mites may severely affect horse health if infestations are unchecked. Mange mite treatment methods for horses are similar to those for beef cattle. Use high-pressure spray applications of approved acaricides at weekly intervals. However, horses' skin is more sensitive to insecticide treatment than is the skin of other animals. Consult a veterinarian for information on the best products for use on horses.

**Companion animals and small animals.** Companion animals (i.e., dogs and cats) and other small animals, such as pet rabbits, can become infested with mange mites or follicle mites, leading to unhealthy conditions of the animals. Dogs can be affected by the scabies mite, *Sarcoptes scabiei* var. *canis*, while cats and rabbits are affected by the burrowing mange mite *Notoedres cati* and the fur mite, *Cheyletiella*. The best treatment for mange mites in these animals is dipping in an approved acaricide. Dusts may be used for light or localized mange mite infestations. These treatments also will kill fur mites.

## TICKS

There are more than 800 species of ticks belonging to two families: the **soft ticks** (family Argasidae, 160 species) and the **hard ticks** (family Ixodidae, 650 species). Ticks are close relatives of mites; many scientists feel that ticks evolved from mites into parasitic associations with animals during the time of the large reptiles (about 200 million years ago).

Ticks are **obligatory** blood-feeders on vertebrate hosts. This means that they depend entirely on blood for food and their survival. They parasitize reptiles, birds and mammals. Unlike mites, there are no ticks that feed on plant juices or prey on other arthropods.

Ticks are of major world-wide veterinary importance for the following reasons:

1. They cause blood loss.
2. Their feeding causes inflammation and irritation of the skin.
3. They may stimulate hypersensitive allergic reactions.
4. They may cause a toxic reaction in the host, complicated by paralysis (called “tick paralysis”).
5. They transmit microorganisms that cause disease.

Arthropods that transmit pathogenic microorganisms are called “vectors” of the diseases that the pathogens cause. For example, *Ixodes scapularis*, commonly called the deer tick, is a vector of Lyme disease.

### Hard Ticks

Ticks are small arthropods, but all life stages can be seen with the naked eye. Figure 3.6 shows an example of a hard tick. The feeding apparatus of a tick, like that of a mite, is called the hypostome. The hypostome allows the tick to suck blood. The legs are segmented. The rest of the body of the tick is the abdomen. On the back of the abdomen of hard ticks is the scutum or shield. The scutum is often colored and has holes and lines in it (called “ornamentation”). The ornamentation of the scutum is important identifying hard ticks. Some hard tick species have ridges or festoons in the abdomen. In female hard ticks, the scutum does not cover the abdomen completely. In male hard ticks, the scutum covers the abdomen. Ticks do not have antennae.

### Soft Ticks

Soft ticks look very different than hard ticks. The hypostome of soft ticks does not project forward — it is tucked underneath the abdomen and



Figure 3.6 The American dog tick (*Dermacentor variabilis*), is an example of a hard tick.

is not visible from above. Soft ticks do not have a scutum, nor do they have elaborate coloration patterns. Instead, the body is covered with bumps and folds.

### Tick Development and Feeding

Biological development of ticks starts with the egg stage and is followed by three more stages: six-legged larva, eight-legged nymph and eight-legged adult. Hard ticks have only one nymphal instar (that is, one molt to the nymph stage, followed by a molt to the adult stage). Soft ticks may have up to seven nymphal molts, depending upon the species of tick and the kind of life cycle involved.

Each stage of a tick must feed on blood. Blood is the sole nutrient source for ticks and allows them to develop and molt to the next stage. For adult female ticks, blood provides the nutrients to develop eggs.

Blood feeding by ticks is a complex behavior and a physiological interaction with the host being fed upon. Ticks usually locate hosts through “questing.” During questing behavior, a tick climbs to a perch (such as a blade of grass or end of a branch) and extends its legs. When an animal brushes against the perch, the tick grabs onto the animal’s fur. The tick then crawls about the body of the animal until it finds a suitable place to attach its mouthparts. The tick inserts its hypostome into the skin and secretes a cement from the salivary glands to hold the hypostome in place. The tick then starts to take blood. For hard ticks blood feeding lasts several days to weeks, depending on the length of attachment. Most species of soft ticks blood-feed for only minutes to hours at a time. Many soft ticks do not quest as described above, but walk to a host to feed.

## Tick Life Cycles

Ticks have complex life cycles involving several blood meals with the same or different animal hosts and may include long periods of time when they are not on a host but living in the environment. Indeed, one of the characteristic features of ticks is that even though they are highly dependent upon blood for food they may survive away from a blood host for long periods. Some species of ticks can live for years without a host.

Soft ticks are usually associated with nests, dens, burrows, or roosts of their animal hosts. Soft ticks usually mate when they are not on a host. Hard ticks are generally not associated so closely with their hosts but are free-ranging and only come into contact with animal hosts for blood feeding. Hard ticks usually mate when they are on a host, oftentimes while the female is blood feeding. Because soft ticks take small blood meals for a short feeding period, the female only lays a few hundred eggs during her lifetime, with eggs laid at intervals. Hard ticks take large blood meals and lay 6,000 or more eggs at one time.

Ticks have four generalized life cycles. These life cycles are related to the number of individual animal hosts a tick will visit and feed on during its life from egg to adult. The life cycles are called **one-host life cycle**, **two-host life cycle**, **three-host life cycle** and **multihost life cycle**. Ticks are often referred to by the kind of life cycle they have, for example, the American dog tick is a three-host tick.

The three-host life cycle has been adopted by about 625 species of the hard tick family and is the most common tick life cycle. The larvae find a host and feed for days, then drop off the host and wait days to weeks for the blood meal to digest. Then they molt to the nymph stage. The nymph finds a new host (of the same or a different species of animal that the larva was feeding upon), blood-feeds, drops off and digests the blood. It then molts to the adult stage. These ticks quest for a new, third host. They feed and mate on this third host. The females drop off after feeding, digest the blood and lay eggs. Males stay on the host, often do not feed, and die after mating.

In the three-host life cycle, the larvae and nymphs typically feed on smaller animals (for example, birds or rodents) than do the adult ticks (for example, deer or cattle). Three-host tick cycles may take years to complete, depending on the environmental and climatic conditions in the area.

The two-host life cycle occurs in 12 of the hard tick species. This life cycle is very similar to the three-host life cycle. Two-host ticks generally do

not occur in North America, though in other parts of the world they are extremely important pests of animals.

The one-host tick life cycle occurs in about 12 species of the hard tick family. Larvae, nymphs and adults all feed upon the same animal host without dropping off of it to molt. One-host ticks are important pests of domesticated animals in North America and elsewhere.

The multihost life cycle is characteristic of nearly all of the species of soft ticks. Multihost life cycles take place in areas where host animals dwell, such as dens, burrows, nests and other shelters. In this life cycle, many nymphal molts occur, and these nymphs are called intermediate stages. Larvae find a host in the shelter and then feed. They detach from the host, stay in the shelter, digest the blood and molt to the first-stage nymph. The nymphs repeat the feeding and other activities of the larvae. Individual nymphs feed and molt several times before molting to the adult stage. Adults quest for and feed on a host in the same shelter as the nymphs and larvae. The adult ticks may feed many times. The female ticks lay small batches of eggs after each blood feeding.

## DETECTING AND IDENTIFYING TICKS

Ticks can be detected on animals by direct examination without use of a hand lens or microscope. Engorged ticks (those filled with blood) are particularly easy to see because they are large and obvious, looking somewhat like a castor bean in shape and color. To find ticks on an animal, ruffle or comb hair or feathers to expose the skin and examine skin directly. Ticks may have preferred attachment sites that protect them to a certain degree from being dislodged by animal grooming. Areas around the head, in the ears, on the shoulders and other parts of the body can harbor attached ticks. On cattle, ticks can be found in highly vascularized areas of the skin (i.e., tail, udder). Unattached ticks can be recovered from the host by combing and examining the comb.

Ticks can be identified using references and biological identification keys. Identification is important because certain tick species transmit agents which cause serious diseases, while others do not. Thus, correctly identifying ticks can help animal health care professionals decide the need for performing diagnostic tests for tick-borne diseases.

A pictorial key to the genera of adult ticks in the United States is given at the end of this chapter. Identification of ticks to particular species often requires contacting experts through local county extension offices or health departments.

Immature ticks, larvae and nymphs, are difficult to identify even with the aid of a microscope. Consult an expert to determine if a particular arthropod is an immature tick and, if so, the species of the immature tick.

## IMPORTANT TICKS AFFECTING ANIMAL HEALTH

There are many species of ticks affecting animal health. Ticks may be found on companion animals, livestock and other animals in agricultural settings and even animals in pet shops or zoos. Additionally, ticks are important ectoparasites of wild animals and may seriously affect the vigor of individuals and the fitness of whole populations.

Table 3.2 lists several important tick species found in the United States, their distribution and common name, which domesticated animals the ticks commonly parasitize and the diseases they are associated with as vectors. The following text provides detailed information about the important ticks of the northcentral part of the United States.

The **American dog tick** *Dermacentor variabilis*, (Fig. 3.6) is widespread in the eastern United States. The American dog tick is brown with white ornamentation on the scutum (shield on the abdomen) in the adult stage. It parasitizes wild, woodland rodents in the larval and nymphal stages, and as an adult it commonly occurs on dogs and wild canines, cattle, horses, raccoons, opossums, and humans.

The American dog tick is a three-host tick. It is an important vector of the microorganisms that causes Rocky Mountain spotted fever. This disease is also known as American tick-borne typhus. Dogs and humans can contract Rocky Mountain spotted fever, a serious and potentially fatal disease characterized by unusual spotted rashes and high fever.

The **winter tick**, *Dermacentor albipictus*, (Figure 3.7) is a common tick with an inactive summer period but an active winter time. Though inactive in the summer, larvae quest for hosts in the fall. They find and parasitize large animals (ruminants and horses) during the winter. It is a one-host tick, spending all of the winter on a host. In the northcentral U.S., this tick is a common

**Table 3.2 Common ticks affecting animal health in the northcentral region of the United States**

<b>Tick Animals Parasitized</b>	<b>Common Name</b>	<b>Scientific Name</b>	<b>Geographical Distribution</b>	<b>Disease Associations</b>
Cattle, horses dogs, cats	American dog tick	<i>Dermacentor variabilis</i>	Eastern U.S., California	Rocky Mountain Spotted Fever
Wide range of birds, mammals	Lone star tick	<i>Amblyomma americanum</i>	Southern states east of Texas	Rocky Mountain Spotted Fever
Ruminants, horses	Winter tick	<i>Dermacentor albipictus</i>	North America, widespread	
Poultry	Fowl tick	<i>Argas persicus</i>	Southern U.S. & sporadically north	
Rodents, cattle, horses deer, dogs, cats	Deer, bear tick	<i>Ixodes scapularis</i>	Upper midwest, eastern coast states	Lyme disease
Dogs mainly	Brown dog tick	<i>Rhipicephalus sanguineus</i>	Worldwide, indoors	



ectoparasite of white-tailed deer, elk and moose. It will also parasitize cattle and horses that are pastured or ranged in winter. Tick loads can exceed thousands of ticks per animal. The winter tick is not a vector of pathogenic microorganisms, but it can cause problems leading to blood loss and allergic reactions in affected animals.

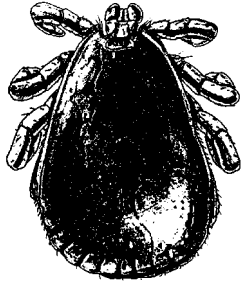

**Figure 3.7 Winter tick (*Dermacentor albipictus*).**  
Source: Peter Carrington

The **lone star tick**, *Amblyomma americanum*, (Figure 3.8) is a common and problematic tick of the southcentral and southeastern United States, but these ticks appear every year in north central states (probably brought up by northwardly migrating birds). The tick gets its name from the bright, lone star-like spot on the scutum. The male and immature ticks lack this spot. Lone star ticks are vectors of Rocky Mountain spotted fever rickettsiae. The lone star tick is a three-host tick. It parasitizes a wide range of birds (particularly by larvae and nymphs) and mammals, including cattle, horses, sheep, dogs and humans.

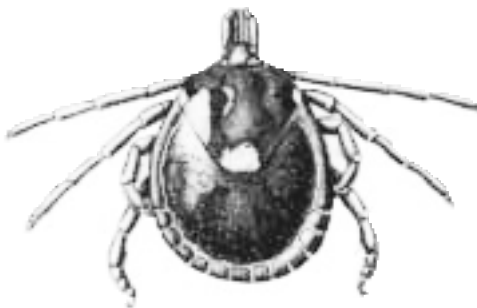

**Figure 3.8 The lone star tick (*Amblyomma americanum*) is a common and problematic tick of the south central and southeastern United States. These ticks appear every year in north central states (probably brought up by northwardly migrating birds).**

The **black-legged tick**, *Ixodes scapularis*, (Figure 3.9) is a three-host tick with a prolonged two-year life cycle. In the larval and nymphal stages, it quests for woodland rodents, such as mice and chipmunks, but it will also parasitize ground-foraging birds. Adult ticks are found on larger-sized wild mammals, but will also parasitize humans, dogs, cats, horses and cattle.

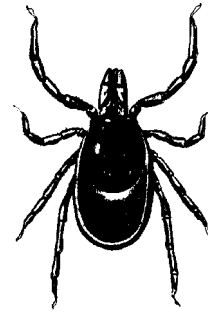

**Figure 3.9 Black-legged tick (*Ixodes scapularis*).**

*Ixodes scapularis* is the vector (transmitting organism) in the eastern U.S. of *Borrelia burgdorferi*, the bacterial organism that causes Lyme disease. Lyme disease is a chronic, debilitating disease that initially manifests itself as a rash in humans and may later lead to chronic arthritis and possibly heart and nervous system problems. Dogs, horses and possibly cattle show some symptoms of Lyme disease, indicating that they can become infected following an infectious tick bite.

Other ticks of veterinary importance in the northcentral region of the U.S. include *Argas radiatus*, the fowl tick. This tick may infest domesticated poultry, but it is rare and occurs mainly in southern states. If importing animals, isolate and examine the them for ticks.

## MANAGEMENT OF TICKS ON ANIMALS

Management of ticks affecting livestock or companion animals varies with the species of tick and kind of animal that needs protection. For large animals, such as cattle and horses, tick control can be enhanced with vegetation management that modifies the tick habitat. Animals can then be pastured in areas where tick questing areas have been reduced.

On animals, tick control can be achieved using approved acaricides by dipping, spraying the entire animal with high-pressure sprays or whole animal dusts. Insecticide-impregnated ear tags offer some protection and control when ticks are infesting mainly the ears.

When only a single or a few ticks are on an animal, simply remove them using tweezers or fingers. Grasp the tick as close to the skin as possible and pull firmly away until it detaches. Be sure not to squeeze the tick – you could cause any disease organism in the tick to go into the animal. Do not remove ticks by burning, or using materials such as kerosene or diesel fuel. With heavy infestations, animals should be dipped, dusted or shampooed with an acaricide and then combed thoroughly to rid the ticks from the body of the animal.

---



## Chapter 3 – Review Questions

**Write the answers to the following questions and then check your answers with those in the back of this manual.**

1. What features of mites and ticks generally distinguishes them from insects?
  - a. Four legs
  - b. Two major body parts
  - c. Three major body parts
  - d. Six legs
2. What four ways do mites affect the health of animals?
  - a. Death.
  - b. Mange.
  - c. Scabies.
  - d. Weight loss.
  - e. b and c.
3. What is one of the most common problems that mites cause in animals?
  - a. Death.
  - b. Mange.
  - c. Scabies.
  - d. Weight loss.
  - e. b and c.
4. Describe the generalized life cycle of mites.
5. How long is the entire life cycle of a mite?
  - a. Eight days to four weeks.
  - b. 24 hours
  - c. Two days
  - d. Two months.
6. Why do sarcoptic mange mites cause intense itching and dermatitis on the animals they infest?
7. Animals affected with sarcoptic mange may scratch so heavily that liquid exudes from the affected skin, causing skin crusts and skin cracking and thickening. (True or False)

8. Secondary infection is common in scratched areas. (True or False)
9. Sarcoptic mange mites typically infest the hairiest parts of an animal's body. (True or False)
10. How can you detect and identify non-burrowing mange mites?
  - a. Observe with a hand lens.
  - b. Comb the animal with a mite comb.
  - c. Skin scrapings.
  - d. a and b.
11. Follicle mites are common parasites of cats, dogs, horses and other large animals. (True or False)
12. In healthy animals, follicle mites normally do not cause any skin deterioration or mange conditions. (True or False)
13. In weak or diseased animals, follicle mites can cause two skin conditions to develop. Describe them.
14. What are the skin conditions caused by follicle mites called?
15. Both endo- and ectoparasitic types of mites exist. (True or False)
16. Describe why ticks are of major worldwide veterinary importance.
17. Each developmental stage of a tick must feed on blood because blood is the sole nutrient source for ticks and allows them to develop and molt to the next stage. (True or False)
18. Ticks can be detected on animals by direct examination without use of a hand lens or microscope. (True or False)
19. If an animal has ticks, what are the control options?

---

## CHAPTER 4

# CHEWING AND SUCKING LICE

### LEARNING OBJECTIVES

After you finish studying this chapter, you should be able to:

- Tell what sucking and chewing lice feed on.
  - Describe the general appearance of lice.
  - Explain the general life cycle of lice.
  - Know what types of lice are associated with various agricultural animals.
- Know where lice typically infest on an agricultural animal's body.
  - Understand how to control lice and prevent the spread of lice on agricultural animals.

---

### CHEWING AND SUCKING LOUSE COMPARISONS

Lice (singular: louse) are insects belonging to either the **sucking louse** order (**Anoplura**) or the **chewing or biting louse** order (**Mallophaga**). All lice are obligatory (dependent on) ectoparasites of birds and mammals. There are about 460 species of sucking lice and 3,000 species of chewing lice. Sucking lice feed solely on blood and have mouthparts designed for sucking. Their mouthparts penetrate the skin and actually fit into a blood vessel, from which the blood meal is drawn. Sucking lice only occur on mammals.

Biting lice have mouthparts designed for chewing, not sucking, and they feed on feathers, hair and skin scales. They live on mammals and birds. An infestation of lice is called **pediculosis**.

Lice are highly host-specific—that is, a particular species of louse is generally associated with only one kind of animal host. Often, a species of louse is restricted to one part of the body of one kind of animal host. Lice do not survive long if they are removed from their host, so they live on the host all the time. They are transferred from host to host by direct contact. Table 4.1 lists the hosts and the common chewing lice associated with them. Table 4.2 lists the hosts and the common sucking lice associated with them.

Infestations of lice are associated with overcrowding and poor sanitation in the animal's environment. Infestations are seen mostly in the

winter, primarily because long winter hair coats are desirable homes for lice. Populations are limited by summer heat.

Lice are wingless insects that are flat from top to bottom. They are usually tiny to minute in size (from 1 to 5 mm in length), though they can be seen with the naked eye. Figure 4.1a shows a typical chewing louse and Figure 4.1b shows a typical sucking louse. The head of a sucking louse is much narrower than that of a chewing louse.

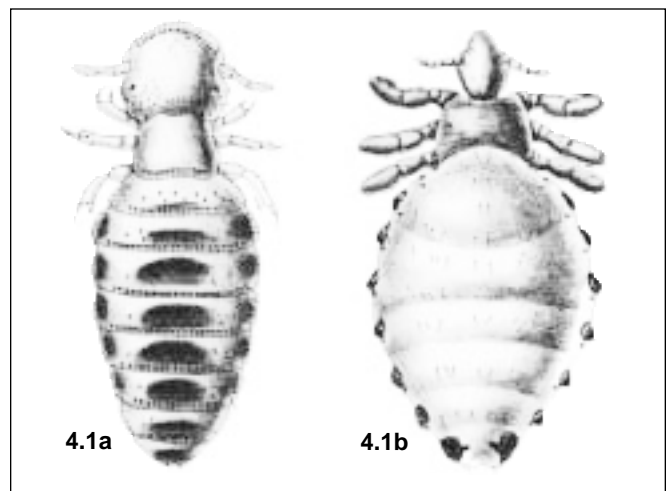

Figure 4.1a shows a typical chewing louse; Figure 4.1b is a typical sucking louse. The head of a sucking louse is much narrower than that of a chewing louse. As a general rule, the *head of a sucking louse is narrower than the thorax* (middle body part), whereas the *head of a chewing louse is wider than the thorax*. The legs often have claws to grasp hairs or feathers.

As a general rule, the **head of a sucking louse is narrower than the thorax** (middle body part), whereas the **head of a chewing louse is wider**

**than the thorax.** The legs often have claws to grasp hairs or feathers.

**Table 4.1 The common chewing (biting) lice affecting animals in the U.S.**

<b>Animal Host</b>	<b>Common Name</b>	<b>Louse Species</b>
<b>Cat</b>	Cat biting louse	<i>Felicola substrata</i>
<b>Dog</b>	Dog biting louse	<i>Trichodectes canis</i>
	Dog biting louse	<i>Heterodoxus spiniger</i>
<b>Horse</b>	Horse biting louse	<i>Bovicola equi</i>
<b>Cattle</b>	Cattle biting louse, Red louse	<i>Bovicola bovis</i>
<b>Sheep</b>	Sheep biting louse	<i>Bovicola equi</i>
	Goat biting louse	<i>Bovicola caprae</i>
<b>Goat</b>	Goat biting louse	<i>Bovicola caprae</i>
	Angora goat biting louse	<i>Bovicola limbatus</i>
<b>Chicken</b>	Wing louse	<i>Lipeurus caponis</i>
	Chicken head louse*	<i>Cuclotogaster heterographus</i>
	Chicken body louse**	<i>Menacanthus stramineus</i>
	Shaft louse	<i>Menopon gallinae</i>
	Fluff louse	<i>Goniocotes gallinae</i>
	Large chicken louse	<i>Goniocotes gigas</i>
<b>Turkey</b>	Chicken body louse**	<i>Menacanthus stramineus</i>
	Large turkey louse	<i>Chelopistes meleagridis</i>

\* The chicken head louse also infests penned pheasants.

\*\* The chicken body louse also infests a variety of other domesticated fowl (guinea and pea fowl, quail, pheasants, ducks, geese)

**Table 4.2 The common sucking lice affecting animals in the U.S.**

Animal Host	Common Name	Louse Species
Dog	Dog sucking louse	<i>Linognathus setsus</i>
Horse	Horse sucking louse	<i>Haematopinus asini</i>
Cattle	Shortnosed cattle louse	<i>Haematopinus eurysternus</i>
	Cattle tail louse	<i>Haematopinus quadripertusus</i>
	Longnosed cattle louse	<i>Linognathus vituli</i>
	Little blue cattle louse	<i>Solenoptes capillatus</i>
Sheep	Face and body louse	<i>Linognathus ovillus</i>
	Sheep foot louse	<i>Linognathus pedalis</i>
Goat	Face and body louse	<i>Linognathus stenopsis</i>
Swine	Hog louse	<i>Haematopinus suis</i>

## LIFE CYCLE OF LICE

The eggs of lice are called **nits** and are cemented to hairs or feathers on an animal host. The eggs hatch and larval lice, called **nymphs**, emerge. Nymphs blood-feed. Nymphs continue to feed and molt three times before maturing into an adult male or female louse. The adult lice mate and the females lay eggs onto host hairs or feathers. The entire life cycle takes up to 30 days or more depending upon temperature. All life stages of lice occur on the host.

## EFFECTS OF LICE ON ANIMAL HEALTH

A single animal may be infested with thousands of lice. Their feeding activity results in hair or feather loss, blood loss, skin irritation and secondary infection. Lousy animals may be weak and susceptible to other infestations or diseases. Infested animals will scratch frequently, worsen-

ing the condition. However, grooming by the host animal may remove lice and help lessen the effects of lice activity. Also, an animal's immune system may affect lice and reduce their numbers. Some animals may be infested with lice and show no ill effects. For example, one study showed that 50% of the individuals in a herd of beef cattle were infested with lice but only 2% were severely infested and showed pathological signs.

## Cattle Lice

Ranged, pastured and confined cattle can be infested with lice. Five different species of lice may infest cattle including both chewing lice (one species) and sucking lice (four species). However, only some of these are common enough to have an important effect on animal health and well-being. Another, cattle tail louse, is tropical and occurs in Florida and the gulf coast states, so it will not be considered here.

The only species of chewing louse that occurs on cattle is the **cattle biting louse** or the **red louse** (see Figure 4.2) probably the most important type of louse on cattle. Like the other species of lice on cattle, populations of the cattle biting louse build up in the fall and peak during the winter months when animals are crowded together. It occurs on both beef and dairy cattle. Lice typically infest the base of the tail, back line and shoulders, but infestations spread to other parts of the body as louse numbers increase. They feed on shed skin scales.

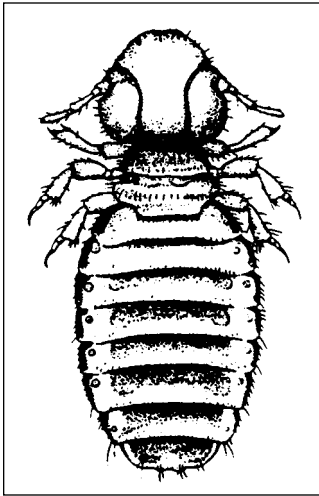

Figure 4.2 Cattle biting louse or the red louse.

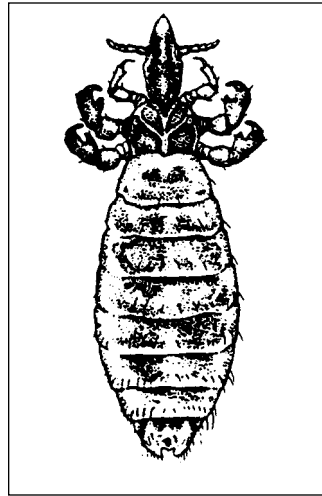

Figure 4.3 Longnosed cattle louse.

The important sucking lice on dairy cattle are the **longnosed cattle louse** (see Figure 4.3) and the **little blue cattle louse** (see Figure 4.4). The **shortnosed cattle louse** (Figure 4.5) occurs mainly on beef cattle but may also occur on dairy cattle. These lice typically occur on the head (base of the horns) and neck, dewlap, back and shoulders, base of the tail and rump.

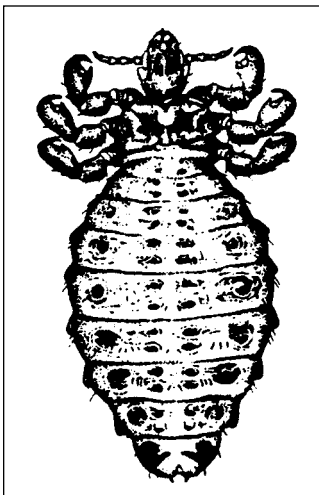

Figure 4.4 Little blue cattle louse.

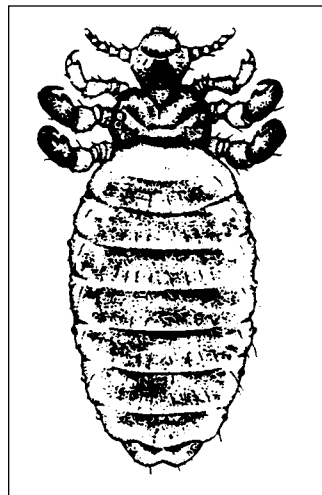

Figure 4.5 Shortnosed cattle louse.

Animals with biting louse infestations may look shaggy, discolored and ragged. They will spend noticeable time licking and rubbing themselves. Usually calves, yearlings and old animals are those that become infested, but cattle of all ages can harbor lice. Transfer of lice from cow to calf provides a mechanism for louse infestation of young animals. Lice must often be controlled or prevented on cattle.

Experts believe that the effects of lice on cattle are greatly underestimated; the USDA estimates that losses in production and costs of control in the beef industry due to lice exceed \$126 million annually. Whether lice cause reductions in milk production in dairy cows is not known. However, there are no good economic thresholds that guide pest control decisions. Some authorities recommend louse control if a moderate infestation of 3-10 lice per square inch of skin is detected. Following these guidelines, an infestation of greater than 10 lice per square inch is a severe infestation. Some authorities recommend control if three lice per square inch are found. Detecting lice on cattle requires direct inspection by two-hand parting of hair and examining hair and skin for presence of lice and nits. If exact species identification is desired, lice can be mounted on glass slides in oil and examined with a microscope.

## Hog Lice

One species of sucking louse occurs on swine, the **hog louse** (Figure 4.6). No biting lice occur on swine. The hog louse usually infests its host behind the ears and between the legs. In heavy infestations, the lice will spread to other areas of the body. All ages of hogs can be infested. The hog louse can carry the virus that causes swine pox.

Hog lice bloodfeed in groups while clinging to host hairs. Lice feeding causes a deterioration of skin because the animals are irritated and scratch and rub heavily at infested sites. Infested animals may become weakened and, consequently, more susceptible to other diseases. Detecting lice on hogs requires direct examination of affected areas.

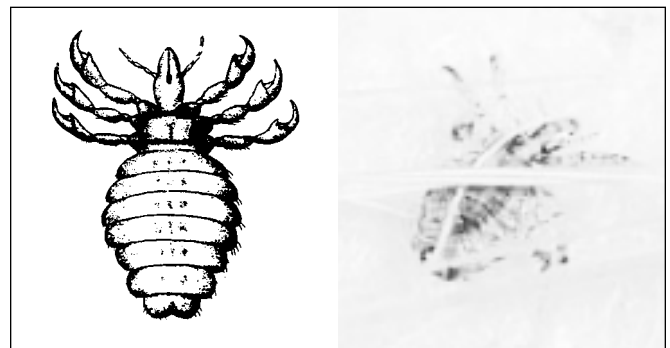

Figure 4.6 Hog louse.

## Sheep and Goat Lice

Sheep harbor two species of sucking louse and one species of biting louse. Louse infestations on sheep are heaviest in winter. Sheep that are heavily louse infested may yield less fleece and fleece of lower quality than noninfested sheep.

The most common louse on sheep is the **sheep biting louse** (Figure 4.7) These lice eat skin scales and irritate the host. Sheep scratch and rub infested areas causing wool loss and fleece damage. The **face and body louse** is often called the **face louse** or **sucking body louse** (see Figure 4.8). It occurs on all parts of the sheep except the limbs. Limited infestations are found mainly around the face wool.

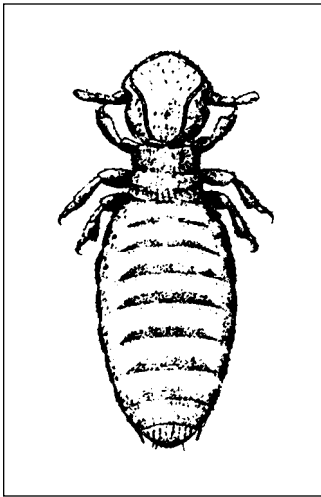

Figure 4.7. Sheep biting louse.

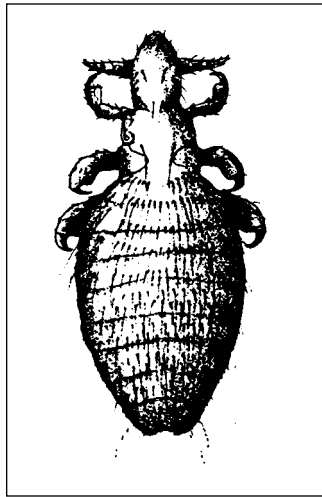

Figure 4.8. Face and body louse or the sucking body louse.

Low level infestations of **sheep foot louse** usually occur on their feet. These lice may spread upward to the legs, scrotum and belly. This louse is more common on rams. It does not cause much injury to sheep.

Goats carry two species of chewing lice and one species of sucking louse. The **goat biting louse** (Figure 4.9) feeds on the skin, but burrows into hair follicles causing itching, inflammation, hair loss and poor hair coat quality. The **face and body louse**, a sucking louse on goats (Figure 4.10) occurs mainly on the neck, underline and around the udder. Another biting louse, the **Angora goat biting louse** occurs on Angora goats. It feeds similarly to the goat biting louse, is similar in appearance and causes damage to the hair coat.

Detection of lice on goats and sheep requires direct examination. Wool and hair deterioration are signs of infestations.

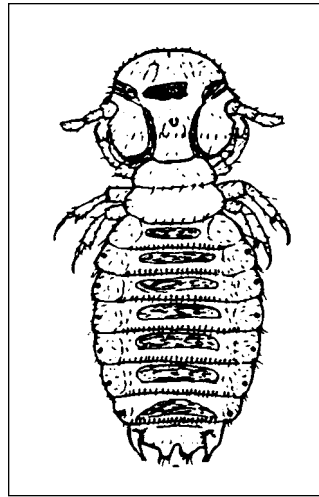

Figure 4.9. Goat biting louse.

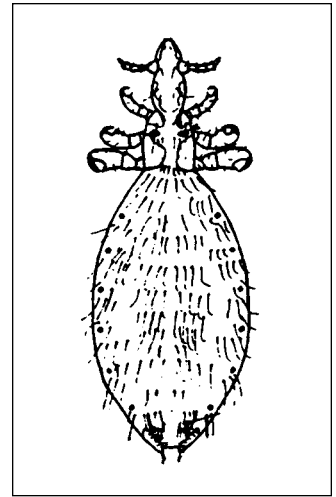

Figure 4.10. Face and body louse of goats.

## Poultry Lice

Chickens and other fowl harbor only chewing lice. Although many species of lice infest poultry (at least six on chickens and two on turkeys), the major species of concern is the **chicken body louse** (Figure 4.11). Body lice on chickens are found close to where the feathers meet the skin. The nits (eggs) are white clusters on the feather shafts. The lice are yellowish-white and can be seen on feathers and skin. They feed on skin scales.

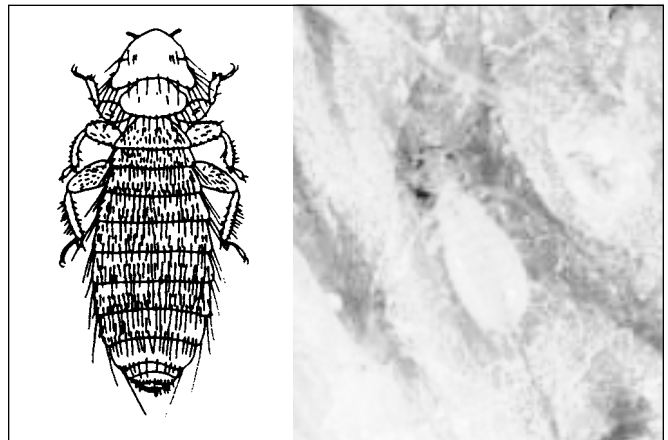

Figure 4.11. Chicken body louse.

Turkeys may also be infested with chicken body louse. Another louse pest of turkeys is the **large turkey louse**.

In contrast with cattle lice, poultry lice are usually more common in the summer than in the winter. Chicken body lice can heavily infest hens in caged layer houses. Some authorities estimate that louse infestations cause as much as 46% decrease in egg production. Lice can be found on poultry by direct examination of skin and feather shafts.



## Lice of Companion Animals and Horses

Dogs, cats and horses may occasionally be infested with lice. There are no sucking lice specific to dogs and cats, but each may be infested with chewing lice. Horses may harbor one species of sucking louse and one species of chewing louse. Both are most likely to infest horses in winter when the hair is long. The **horse biting louse** feeds on skin debris as do other biting lice. The **horse sucking louse** is similar in appearance and biology to other sucking lice. To prevent lice from moving among horses in an infested herd, disinfect saddle blankets, curry combs, brushes and tack. Because horses do not tolerate pressure sprays well, apply insecticides with a wet sponge.

## MANAGING LICE ON CATTLE AND OTHER LIVESTOCK

Preventing lice infestations involves isolating or culling chronic louse carriers so that lice will not be transferred to non-infested animals. Check animals and treat for lice before adding them to a herd or flock.

When lice reach unacceptable numbers on individual cattle as determined by thresholds, behavioral changes or by being spread to other members of a herd, then lice must be controlled. Some recommendations suggest pest control treatments if three lice per square inch are found. An infestation of greater than 10 lice per square inch is considered severe. Louse control on animals involves use of insecticides. Some insecticides cannot be used on calves under 3 months or on lactating cows. Other insecticides have treatment intervals related to slaughter times to prevent insecticide residuals in the meat. Read all label directions and precautions before applying products to animals.

Cattle often have both louse and grub (fly maggots, see Chapter 6 – Flies) infestations at the same time. **Early** fall applications of some insecticides provide both lice and grub control. These applications may be pour-ons, coarse sprays, spot-ons, dips or injections. Once fly grubs enter a cow's body and begin developing (approximately November 1 to February 1), systemic insecticides can not be used for louse or grub control. This is because if grubs are killed when inside the

animals body they decompose, releasing toxins. These grub toxins cause a toxic reaction in cattle and possibly death. Only surface applied insecticides that are non-systemic should be used for louse control during winter periods. It is during the winter that cattle louse numbers often peak and grubs may be developing internally. Therefore, pest managers must select their management tactics carefully.

Check treated animals for lice at two-week intervals after application, and retreat if lice are found. Retreatment is often necessary because many insecticides do not kill lice eggs or nits. Eggs that survive an insecticide treatment may hatch and reinfest the animal.

Lice control measures on hogs are similar to methods used for mange control (see Chapter 3). The lice life cycle must be completely broken on each animal. Follow all precautions when handling and treating baby pigs since they are very susceptible to insecticide toxicity. Therefore, the least risky louse management for swine is to control them on the sow. If the sow does not have lice, the suckling pigs will not be infested from contact with their mother.

Certain insecticides are not labeled for use on lactating or gestating sows or young pigs. If lice are present, treat newly weaned pigs and finishing pigs. Treat boars for lice before breeding. The intervals before slaughter vary from 0 to 30 days depending on the insecticide used. Apply insecticides as coarse sprays, pour-ons, dips, dusts or injections. As with cattle, monitor swine for lice at two-week intervals after application and retreat if newly hatched lice appear.

Louse control on sheep and goats is accomplished with sprays, dips or pour-ons of registered insecticides. Lambs under three months should not be treated with some insecticides. Follow all label directions carefully. Additionally, treatment-slaughter intervals of 15-30 days apply in certain cases.

Louse control on poultry requires pressurized spray applications of wettable powder or emulsifiable concentrate insecticides to the bodies of birds. Dusts or other appropriate insecticide formulations must be applied to the nest boxes and litter at the same time the birds are being treated. Treating one and not the other will not result in an effective louse control program.

---



## Chapter 4 – Review Questions

**Write the answers to the following questions and then check your answers with those in the back of this manual.**

1. What do sucking lice eat? How do they obtain it?
2. Lice can survive for extended periods of time between hosts. (True or False)
3. Describe the physical difference between sucking and chewing lice.
4. List two ways lice infestations can be influenced or reduced on animals.
5. Why is it important to control lice on both adult animals prior to mating?
6. To prevent reinfestations from surviving eggs, the of the \_\_\_\_\_ lice must be completely broken on each host animal.
7. The cattle biting lice:
  - a. populations typically build up in the spring and summer.
  - b. only occurs on beef cattle.
  - c. typically infest the base of the tail, back line and shoulders first.
  - d. feed on blood.

---

# CHAPTER 5

# FLEAS

## LEARNING OBJECTIVES

After you finish studying this chapter, you should be able to:

- Identify a flea and describe its appearance.
- Explain the life cycle of fleas.
- Know which stages of the flea live on the animal and which do not.
- Describe the reasons that fleas are pests to animals.
- Understand how flea bite dermatitis develops and affects the animal.
- Develop an integrated flea management program.
- Understand and follow all precautions for human and animal safety when selecting and using flea control products.
- Explain the importance of treating the animal as well as the animal's environment when controlling flea populations.
- List the components of an effective flea larvae control program.
- Explain the importance of regular sanitation in controlling fleas.

---

## FLEA LIFE CYCLE

Fleas are insects of the order Siphonaptera (meaning siphon-like mouth and no wings). They are very small (2 to 4 mm in length), brown and flattened from side to side. Flea eggs are glossy white and oval. Immature fleas (larvae) are hairy and maggot-like in appearance. There are three instars, or developmental stages, of flea larvae, beginning with the larva that hatches from the egg. The second instar molts, or sheds the skin, and emerges out of the first instar. The third instar flea larva does the same, emerging from the second instar skin. With each molt, the flea larva grows larger. The third instar flea larva spins a silken cocoon and covers the cocoon with material from its environment. It molts inside of the cocoon to become a pupa. After a period of development the adult flea emerges from the pupa. The entire life cycle of a flea, from egg to adult, may take as few as 12 days or may last as long as 140 days, depending on temperature. Also, fleas may “rest” in the pre-emerged adult stage, inside the cocoon, if no hosts are available for the adults to jump onto.

Though there are over 2,000 species of fleas, the life cycle is similar in almost all of them. Adult

fleas obtain a blood meal from their animal hosts. They do not utilize any other kind of food. Thus, adult fleas are ectoparasites. In contrast, flea larvae live in the environment near the host animal but do not live on the animal. So, flea larvae are not ectoparasites.

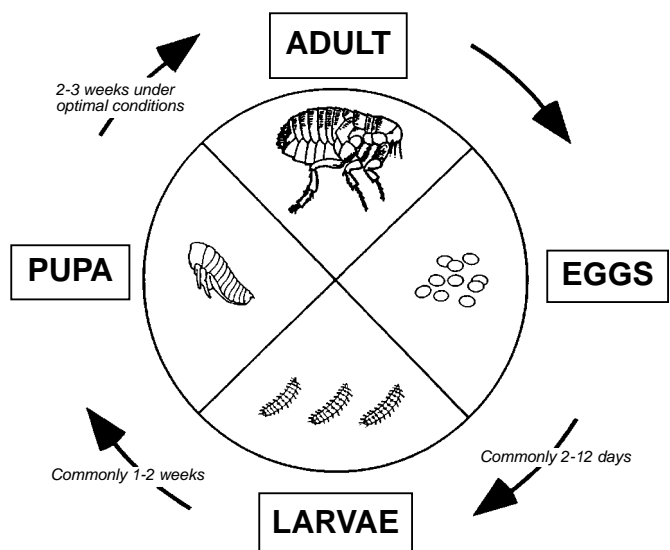

Figure 5.1 Flea life cycle.

The fleas of primary importance to domestic animals, whether companion or food animals, are the dog flea, cat flea and sticktight flea. Table 5.1 lists the scientific and common names of some fleas and shows which animals commonly serve

as their hosts. Dog and cat fleas are intermediate hosts for dog tapeworms. The sticktight flea is found only in the southern United States in association with poultry in poorly managed situations.

**Table 5.1 Common fleas affecting domesticated animals in the U.S.**

Host Animal	Flea Species	Common Name
Swine	<i>Ctenocephalides felis</i>	Cat flea
Chicken	<i>Echidnophaga gallinacea</i>	Sticktight flea
Ferret	<i>Ctenocephalides felis</i>	Cat flea
Dog	<i>Ctenocephalides canis</i> <i>Ctenocephalides felis</i>	Dog flea Cat flea
Cat	<i>Ctenocephalides felis</i>	Cat flea

## DOG AND CAT FLEAS: LIFE HISTORY

In many parts of the United States, the dog flea has been replaced by the cat flea as the most commonly found flea on both dogs and cats. These fleas are so similar in appearance and biology that we can treat them as basically the same. However, the scientific names are different. The dog flea is called *Ctenocephalitides canis*, and the cat flea is called *Ctenocephalides felis* (dog flea and cat flea will do).

The cat flea is an extremely important pest of these animals. In instances of heavy infestation where there are many fleas on an individual animal, the blood loss can be great and lead to poor animal health. Young animals may become anemic (weakened by blood loss) from heavy, regular feeding by fleas. Kittens and puppies can die from heavy infestations of fleas. At the least, flea bites are very irritating and cause animals to itch, which leads to scratching, adding to the irritation of their skin. Additionally, many dogs and cats develop flea bite dermatitis, an allergic condition that can be brought on by a single flea bite in an allergic or sensitized animal. In extreme conditions, animals develop “hot spots” (or “acute moist dermatitis”) where they continually scratch at highly inflamed sites on the skin, creating conditions for bacterial infection. A hot spot is painful to the animal and may exude pus.

Dog and cat fleas have very similar life cycles. (Figure 5.1.) The adult fleas spend virtually all of their lives on the host. They mate on the host, and both male and female fleas feed on blood by biting their host. The fleas feed daily and the female fleas lay eggs that drop from the host animal into the environment. A female lays a few eggs each day and several hundred over the course of her life. Flea eggs accumulate in areas where the host spends most of its time. In addition, the fleas defecate small pellets of digested blood into the host hair. These feces also drop off into the environment. A flea comb will gather these feces and flea eggs at the base of the tines. This provides evidence of flea infestation on dogs or cats.

Flea larvae occur indoors and outdoors, wherever the eggs have fallen off of the host. In houses, flea larvae live in carpeting, furniture, animal bedding and other protected areas with high humidity. Flea larvae can also live outdoors in areas where animals spend time (such as under porches, in dog houses, etc.). Because flea larvae depend upon the fecal pellets of dried blood produced by the adult fleas for food, larvae cannot survive in places that do not get a steady supply of adult flea feces. Therefore, flea larvae do not live in lawns or other outdoor areas unless the pet frequents those areas enough to provide food for the larvae.

Adult fleas inside the cocoon, called pre-emerged fleas, can stay in that condition for weeks to months if no host is available. However, when disturbed by the presence of a host (such as passing vibrations, carbon dioxide from exhaled breath, or other factors), the pre-emerged fleas activate, leave the cocoon and jump onto the host. This is why it is possible to return to a house or apartment that has been empty for months and find it full of fleas.

## FLEA MANAGEMENT

Managing fleas on animals requires an integrated approach. Both the host animal and the environment must be treated at the same time to be effective. Control of fleas on the animal generally requires the use of insecticides. Although flea combs can remove some fleas, combing is a better method for detecting fleas than for removing them from the animal.

**Insecticides.** A range of insecticides in the organophosphate, carbamate, pyrethrin and pyrethroid categories are available for flea control on the animal. Greyhounds and cats are more sensitive to insecticide products than most dogs. Read all insecticide labels and follow all precautions and dose directions. Consult a veterinarian if you have questions. The pyrethrins and pyrethroids have the lowest mammalian toxicity. These insecticides come in formulations such as shampoo, dust and powder, mousse, aerosol and non-aerosol mist or spray, dip, spot-on, roll-on and collar. Organophosphate drugs are also available, by prescriptions from veterinarians, for oral use. Some on-animal formulations contain insect growth regulators that kill flea eggs on the animal.

**Treating the animal.** When treating an animal, the applicator must take precautions to protect him- or herself from contact with the insecticide. All personal protective equipment listed on the label must be worn. As a minimum, chemical-resistant gloves, apron and goggles should be worn while mixing insecticides and during application to prevent insecticide contact with the skin. The working area should be appropriate for containment of the pesticide and should be resistant to caustic materials. A stainless steel preparation table and stainless steel or ceramic tub have these qualities.

The insecticides used for flea control vary widely in toxicity and efficacy. Considerations for selecting a formulation include the size and weight of the animal as well as the species. For example, cats groom themselves more than dogs and are more likely to ingest an insecticide and become poisoned by licking the residue from their fur. Cats are more sensitive to organophosphate



Mixing insecticides before shampooing an animal requires protective equipment and a good working surface.



Protective equipment (gloves, apron, goggles) should be worn during insecticide applications onto animals.

insecticides than are dogs. Some insecticides that can be used on dogs cannot be used on cats. Read and follow all label directions. Kittens and puppies, because of their smaller size, require a lower dose than do adult animals. Young animals may also require treatment with insecticides of lower toxicity than adult animals. Some products should never be used on puppies or kittens. Pregnant or nursing animals may be sensitive to certain insecticides. Veterinarians should have accurate information on insecticides and their use for flea control on animals. The insecticide label contains accurate information on how a particular formulation of an insecticide should and should not be used. **READ THE LABEL BEFORE OPENING THE CONTAINER!**

**Treating the animal's environment.** The other important part of an integrated flea management program is to control larval fleas in the environment or larval habitat away from the animal. This can be achieved mechanically or physically and with insecticides.

Mechanical or physical control of flea larvae requires removing and laundering animal bedding and thoroughly cleaning areas frequented by the animal. Vacuuming with a beater bar and immediately disposing of the waste bag (to prevent eggs from hatching) effectively eliminates up to half of the larvae and eggs in carpet. Do not put insecticides in the vacuum cleaner bag. This is an illegal use of the products and can harm you, your family and pets by creating dusts or fumes that could be inhaled.

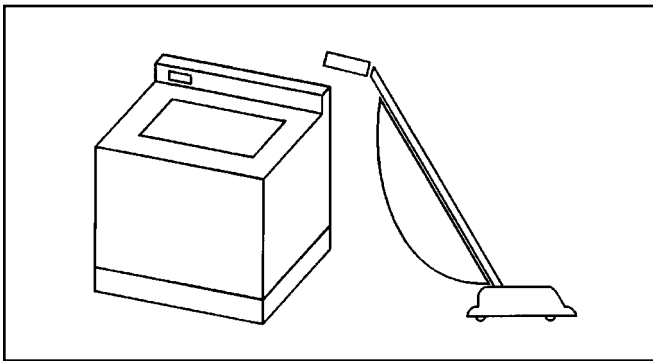

**Launder animal bedding and thoroughly clean areas the animal frequents. Dispose of the vacuum waste bag after every cleaning.**

Carpet shampooing rids the carpet of blood feces, an important food for the larvae, and may also remove eggs and larvae. In outdoor areas, cleaning up the places where animals like to rest reduces eggs and larvae and removes blood pellets. In yards and kennels, flea larvae will be found in cracks at wall-floor junctions and in floor crevices. These areas must be thoroughly cleaned and then maintained to prevent another infestation.

Chemical control of flea larvae can be achieved with insecticides. Organophosphate, carbamate, pyrethrin, pyrethroid and growth regulator (hormone mimic) insecticides and certain minerals are available for flea control in the environment. These insecticides are formulated as coarse sprays, foggers, dusts or are microencapsulated. All but the growth regulators kill flea larvae on contact. Insect growth regulators prevent flea larvae from developing to the adult stage. Growth regulators may also inhibit egg hatching. A good flea larval control program incorporates sanitation, contact insecticides and growth regulators for good results.

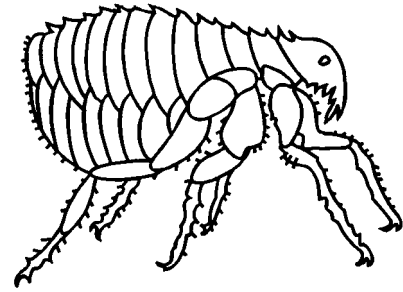

Flea management requires patience, time and careful planning. Vacuuming and cleaning of areas frequented by dogs and cats should be a regular, routine part of house cleanliness and pet care. The same applies to kennels. If an infestation occurs, insecticide applications on the animals or in the environment may have to be repeated according to the intervals listed on the label and depending upon the efficacy of the treatments. Retreatment and time intervals between insecticide treatments will vary with the kind of insecticide and the formulation.

Successful flea control will not happen if only one approach, such as dipping the dog, is used. The animal and the environment in which it lives must be treated simultaneously, and that treatment must be combined with regular sanitation efforts. Read all product labels carefully. Do not overexpose your pet by combining too many treatments at one time, such as a collar, a shampoo and a dust. Pesticides have a cumulative effect. Be aware of each product's toxicity and do not endanger yourself or the animal by using excessive amounts of any one product or by combining products.

When using insecticides for flea control, remember that the applicator and the animal owner can be exposed to the insecticides at several times in the management process. The label may call for the use of gloves and other protective equipment during application and suggest the pet not be handled with unprotected hands until the treatment dries. Also, certain parts of the pet's body (such as the eyes) may be sensitive to the insecticides and must be shielded during application.

The applicator should follow label directions and application guidelines carefully to minimize exposure during and after application. When using flea "bombs" (aerosol cans with a self-releasing mechanism), follow all the precautions and remove the pets from the area being treated. Using excessive rates is illegal and can result in fires and even explosions.

---



## Chapter 5 – Review Questions

**Write the answers to the following questions and then check your answers with those in the back of this manual.**

1. Kittens and puppies can die from heavy infestations of fleas. (True or False)
2. What is “flea bite dermatitis”?
3. How does a flea infestation lead to the development of “hot spots” (or “acute moist dermatitis”) on animals?
4. Dogs are the only hosts for dog fleas and cats are the only hosts for cat fleas. (True or False)
5. How many eggs might a female flea lay in a day? How many eggs would she lay in her life?
6. Flea eggs can accumulate on the host as well as in areas where the host animal spends most of its time. (True or False)
7. Flea larvae feed on:
  - a. Fur.
  - b. Animal dander.
  - c. Lawn grasses.
  - d. Adult flea fecal pellets of blood.
  - e. All of the above.
8. What are two important parts to an integrated flea management program?
9. Cats are more sensitive to organophosphates than dogs. (True or False)
10. Releasing excessive rates of flea “bombs” can result in \_\_\_\_\_.

---

## CHAPTER 6

# FLIES

### LEARNING OBJECTIVES

After you finish studying this chapter, you should be able to:

- Understand the general life cycle of flies.
- List the three groups of biting and nuisance flies.
- Explain how various flies are pests of animals.
- Describe the three components of a biting-fly management program.
- Explain why house fly populations can quickly build to enormous levels.
- Understand the need for an integrated management program for filth flies and animal waste management.
- Describe the options available for managing flies on and around animals.

---

Flies are insects with only one pair of wings. They belong to the insect order called Diptera (meaning “two wings”). Although most kinds of flies are harmless to animals, several families of flies are major pests of animals and often require management. Some flies are vectors of animal diseases.

The fly pests of animals fall into three groups:

- **Blood-feeding flies** not associated with manure or animal waste.
- **Filth flies** associated with animal waste or manure.
- **Parasitic bot flies.**

All flies have a true metamorphosis life cycle (the immature stages or larvae appear worm-like and may sometimes be true maggots). Some filth flies, especially the stable fly, are also blood feeders.

### BITING, BLOOD-FEEDING FLIES

Blood-feeding flies: Mosquitoes, black flies, biting midges, deer flies, and horse flies are blood-feeding flies. Only the female flies take blood. They use it for egg yolk development inside the abdomen. The females have piercing mouthparts that are either blade-like and cut the skin or needle-like and pierce the skin. The mouthparts taken together are called the proboscis. Male flies in these groups feed on nectar or other sugar

sources. Table 6.1 lists the groups of blood-feeding flies. Various blood-feeding flies are shown in Figure 6.1.

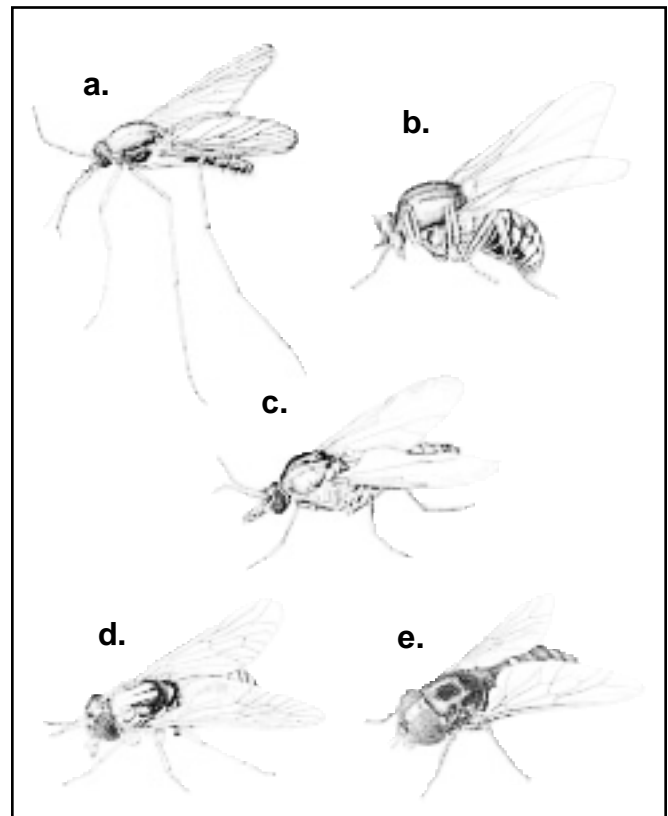
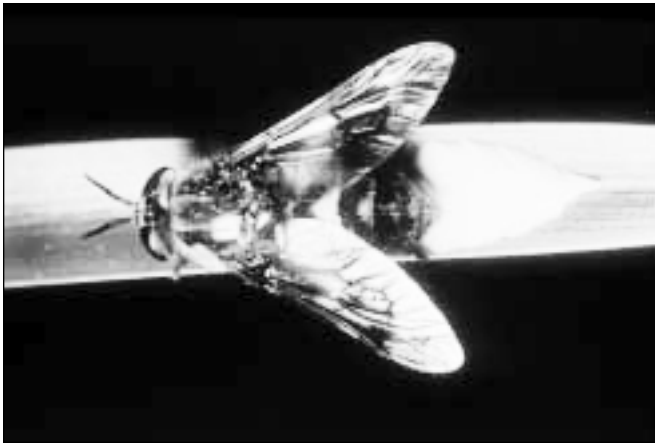

Figure 6.1 Blood-feeding flies: a. Mosquito b. Black fly c. Biting midge d. Deer fly e. Horse fly.





Horse Fly

**Table 6.1 Blood-feeding flies affecting domesticated animals in the United States.**

Common Name	Scientific Family
Mosquito	Culicidae
Black fly	Simuliidae
Biting midge	Ceratopogonidae
Deer fly	Tabanidae
Horse fly	Tabanidae

**Mosquitos'** developmental cycle includes an aquatic larval stage. Mosquito eggs are laid singly or in clusters on or near water. Larvae hatch from the eggs and develop in the water. The larvae feed on a variety of microorganisms and organic matter in the water and develop through four larval stages or instars to the pupal stage. Adult mosquitoes emerge from the pupae and fly away. Female mosquitoes seek out animal hosts by using cues such as carbon dioxide and moisture in exhaled breath to find them. Most mosquitoes seek hosts in the evening or at night, though some bite in the daytime. Once they have found an animal host, mosquitoes search its body until they find a bare patch of skin. Then the mosquito probes the skin with its needle-like mouthparts, finds a blood vessel and sucks blood. Usually only a few minutes are required for blood feeding. Some large animals may experience hundreds to thousands of mosquito bites per night if left unprotected. After blood feeding, the engorged female mosquito leaves the animal and rests in the environment while the eggs develop. She then lays eggs and seeks a host for blood again. A single mosquito may bite several times in its lifetime.

Mosquito



Many mosquitoes bite domestic animals and cause injury by blood loss and create wounds where bacteria may invade and cause infection. Some animals may develop allergies to mosquito bites. In addition, mosquitoes transmit disease agents to animals. For instance, **dog heartworm** is caused by a nematode. Infected dogs end up with adult worms in their hearts. The adult worms shed tiny, immature worms called microfilariae into the bloodstream. When mosquitoes bite an infected dog, the microfilariae enter the body of the mosquito with the blood. The microfilariae develop in the mosquito to a stage that is infective to the dog. Days to weeks later, when the mosquito locates another dog, it transmits the worms during blood feeding. A single infected dog in an area can be an infective source for uninfected dogs for miles around. Thus, it is important to protect dogs from heartworm through preventive drugs and to keep them safe from mosquito bites. If left untreated, heartworms in dogs can cause heart failure and death.

**Eastern equine encephalitis** is a disease of horses, pheasants and humans caused by a virus. The virus is transmitted by swamp mosquitoes among wild birds such as cardinals and cat birds. Sometimes the virus extends from its natural swamp-bird cycle to horses and other dead-end hosts by biting mosquitoes. Encephalitis in horses is a severe disease and usually leads to rapid onset of symptoms and death. Horses can and should be vaccinated for encephalitis in areas where the disease occurs to protect them and their owners from disease.

**Fowl pox or avian pox** is a viral disease of domestic fowl and wild birds. The virus can be passed by direct contact among birds, such as chickens in breeder or broiler houses. Bird-biting mosquitoes in the genus *Culex* can also transmit the virus among birds and may be important vectors when birds are confined together. Mosquito control inside poultry houses is an important emergency measure during outbreaks of fowl pox in chicken flocks.

**Black flies** may be severe seasonal parasites of large animals in Michigan. The larvae occur in slow- or fast-moving streams and rivers where they cling to rocks and filter out food particles from the passing water. The larvae pupate on the rocks, then the adult black flies emerge, swim to the water surface and fly away. Female black flies swarm around and onto the bodies of animals. The bites are very irritating and large numbers of bites can cause severe reactions such as toxemia or anaphylactic shock (allergic reaction). In some instances, high numbers of black flies caused blood loss so extreme that cattle have died of anemia. Black flies can transmit a malaria-like disease to waterfowl.

**Biting midges** — also called “punkies,” “no-see-ums,” or “sand flies” — are tiny biting flies with speckled wings. The larvae occur in still or moving water, where they live in the mud, sand or debris at the bottom. Though these flies are very small, their bite is very irritating. Bites may swell and form bloody, weeping lesions similar to black fly bites. Biting midges transmit a nematode parasite of horses that causes a disease called **fistulous withers**.

**Deer flies** and **horse flies** are large-bodied flies and strong fliers. They live as long as six weeks. The larvae are found in a variety of aquatic and semi-aquatic conditions and in moist soil, where they live in the mud and sediments and prey upon worms and insects. Most horse and deer flies have only one generation per year. The adults emerge in early to mid-summer. Adult females obtain a blood meal and later lay eggs on vegetation above still water or moist soil. After hatching, larvae drop into the water, develop and crawl to drier areas to become pupae. This insect overwinters as a mature larvae.

Deer and horse fly bites are painful and injurious. The flies bite by a scissors-like action of their bladed mouthparts causing a pool of blood to form, which they then suck up. The flies bite during daytime hours. Animals can injure themselves by attempting to drive off or escape from these flies. Deer and horse flies are important vectors of the virus that causes **equine infectious anemia** or **swamp fever** of horses. There is no treatment for this disease once a horse becomes infected.

## MANAGEMENT OF BLOOD-FEEDING FLIES

Managing biting flies to prevent bites is an important part of animal health care, for both companion animals and livestock. There are three components to biting fly management. First is modification of the habitat and environment. For mosquitoes, this means eliminating local sources of standing water around the animals. Most mosquitoes come from true wetlands, however, so draining larval breeding sites is usually not possible nor desirable and must be done with the approval and collaboration of natural resources authorities. Control of larval mosquitoes with insecticides is feasible but this is a specialized discipline requiring training and expertise. The best approach to mosquito control is a regional (e.g., township or county) system utilizing multiple strategies for control of larval and adult mosquitoes. Extension bulletin E-2180, “Mosquito Control,” is a training manual for mosquito management and pesticide applicators’ certification that describes various control measures in detail.

Little can be done about the immature stages of black flies, biting midges, deer and horse flies. Black fly larvae can be controlled in streams with insecticidal bacteria, but this strategy requires permits and consulting with experts.

The second component to biting fly management is to separate the animals from the flies through physical means. Animals can be stabled or kept indoors when the flies are biting. Sometimes, cattle or horses can be pastured in areas distant from larval breeding sites of biting flies, or put to pasture at times when fly biting is low.

The third component to biting fly management is the use of repellents on the bodies of animals and insecticides applied to the animals directly or in their immediate environment. For mosquito control, residual premise sprays of insecticides are effective when applied to areas where mosquitoes rest, including barns or animal dwellings, sheds and vegetation. Ultra-low volume application of insecticides is an effective way to control mosquitoes and other small biting flies both inside and outside premises. Thermal fogs can also be used inside and outside dwellings for mosquito control.

In general, insecticide use for control of biting midges, black flies, deer and horse flies is limited to topical applications directly on animals. Black flies often attack the ears of animals, so applying mineral oil or mild insecticides to the ears can provide relief to an animal. Follow all label directions.

## NUISANCE FLIES

**Filth flies associated with farm and animal waste.** Filth flies often constitute a problem for swine, dairy, beef and poultry production facilities. Though less common, filth flies can also be a problem in pasture settings. Filth flies affect livestock production by their annoying or blood-feeding activity which causes reduced milk production, decreased weight gains, or other undesirable consequences. Some filth flies are vectors of disease agents to livestock and humans.

Additionally, the close proximity between livestock production facilities and human settlements has created situations where filth flies become a source of annoyance and concern for farm neighbors. On the other hand, maggots of filth flies play an important ecological role—they degrade manure to simpler constituents and reduce the volume of waste material. As pests and disease vectors, filth flies often must be managed. Table 6.2 lists the filth flies and Figure 6.2 shows certain adult filth flies.

**Table 6.2 Filth flies affecting domesticated animals in the United States.**

Common Name	Scientific Name
House fly	<i>Musca domestica</i>
Stable fly	<i>Stomoxys calcitrans</i>
Face fly	<i>Musca autumnalis</i>
Horn fly	<i>Haematobia irritans</i>

Filth flies, like other true flies of the insect order Diptera, have four life stages: egg, larva (or maggot), pupa and adult. Perhaps the most important filth fly with widespread distribution in Michigan is the **house fly**. Larvae of this fly develop in a wide range of materials including fresh manure, animal waste mixtures of manure, straw, hay, silage, or feed and garbage. The adult flies are gray/black with yellowish sides and are 6 to 7 millimeters long. They have sponging mouthparts and lap up materials from animal wastes and liquefying matter. Under typical summer conditions, house flies can achieve 10 to 12 generations per year (with 8 to 22 days required for a full development cycle from egg to adult), so these flies increase in number as the summer progresses. The adult flies commonly migrate 1 to 3 miles and movement up to 13 miles within 24 hours has been documented.

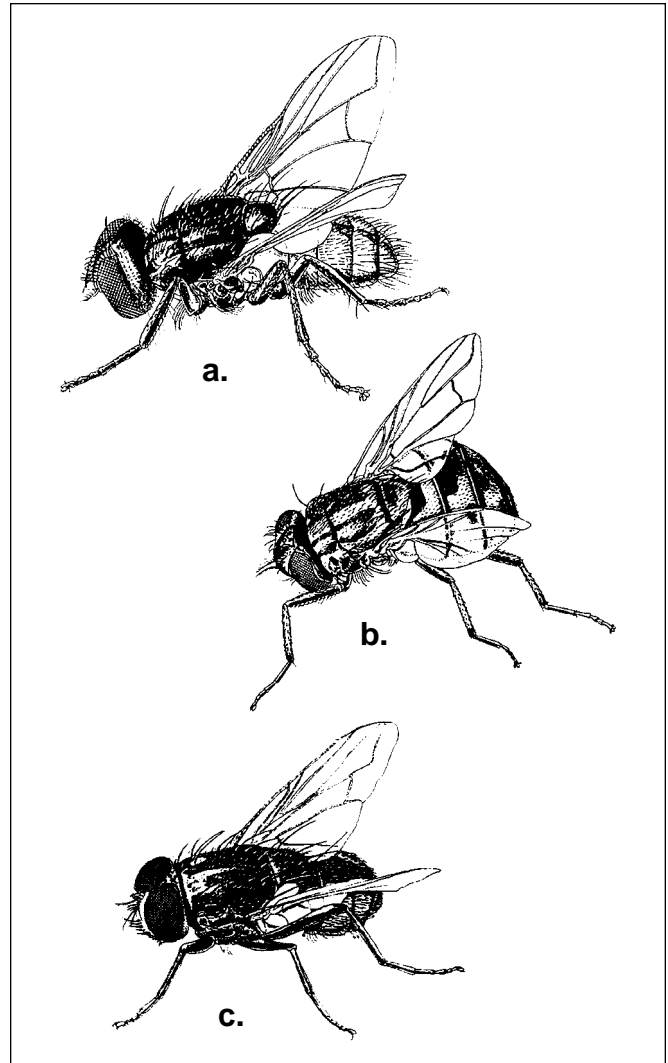

**Figure 6.2 Adult filth flies: a. House fly b. Stable fly c. Face fly.**

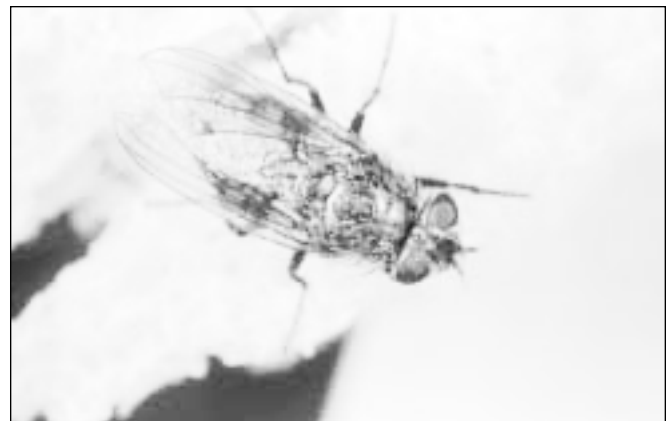

**House Fly**

House flies are known vectors to cattle of the bacteria causing summer mastitis and pinkeye. House flies can also serve as intermediate hosts for a roundworm parasite of horses.

House fly populations can build to enormous numbers in agricultural settings. The annoyance factor for livestock is difficult to assess, but the buzzing sound of the flies and their aggregation when feeding at sores and mucous membranes may cause undesirable behavioral changes in livestock. Annoyance of house flies for humans is well known.

Another filth fly associated with livestock farms in Michigan is the **stable fly** (*Stomoxys calcitrans*). The stable fly is nearly identical to the house fly, but can be distinguished by checkerboard markings on their back and their long, distinctive, bayonet-type mouthparts. Adults of both sexes are blood-feeders. Both sexes inflict a very painful bite, irritating to the host. Each fly may bite several times per day. They are voracious blood feeders and have been known to follow livestock for great distances. Most of the time, however, stable flies present a problem around feedlots and loafing pens and other animal confinement areas.



Stable flies on the legs of a calf.

The larval habitat of the stable fly also differs from that of the house fly. Maggots of stable flies do not occur in fresh manure, but are found in manure-straw mixtures, urine-soaked feed and straw and other materials that may ferment such as stored damp feed, grass clipping piles and round hay bales. Calf hutches or swine farrowing areas, for examples, are an important breeding ground for stable flies because of the accumulation of urine, manure and straw. These flies swarm onto the bodies of livestock and cause considerable annoyance, blood loss and create the possibility of secondary infection of sores produced by fly feeding. The stable fly serves as a biological vector of *Habronema microstoma* a parasite of the stomach in horses. The larvae of this parasite are responsible for summer sores, a skin irritation found around the eyes of horses.

Stable flies harass dogs (one common name for stable fly is “dog fly”) and prefer to feed on the ears. Fly bite dermatitis (Fly bite ears) is caused by the rasping teeth and mouthparts of stable flies. These flies affect the faces and ears of dogs. Lesions are seen on tips of ears or at the folded edge of flop-eared breeds. The lesions may have dark crusts and be oozing blood and serum.



Stable fly.

Protect animals from stable fly attacks by using repellents such as sprays or pastes. Keep the animal indoors or in a shelter when fly populations are high. Proper handling and disposal of manure and compost are essential and may require insecticide treatments.

The adult stable flies prefer strong light and are more abundant in summer and autumn. Stable flies will migrate long distances (100 miles or farther) and may accumulate at shorelines and bite vacationers.

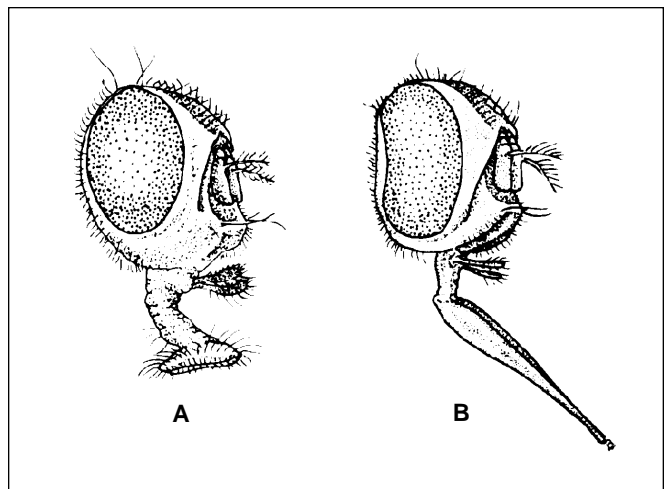

Figure 6.3 Heads of adult house fly (A) and stable fly (B) showing differences in the mouthparts. Credit: Ciba

**Table 6.3 Comparison of filth flies affecting agricultural animals.**

Common Name	Egg laying and larval habitat	Adult description	Mouth parts	Pest behavior
<b>House Fly</b>	Fresh manure, animal waste mixtures of straw, hay, silage, or feed and garbage	Gray/black with yellowish sides, 4 dark lengthwise stripes on thorax; 6 to 7 mm long.	Sponging	Annoyance. Bacterial vector to cattle of summer mastitis and pinkeye. Also, intermediate host for a roundworm parasite of horses.
<b>Stable Fly</b>	Manure-straw mixtures, urine-soaked feed and straw and other materials that may ferment such as stored damp feed, grass clipping piles and round hay bales. <i>Not</i> in fresh manure.	Four dark longitudinal stripes on thorax, several dark spots on abdomen; 6 to 8 mm long; "squats" when at rest.	Chewing	Blood-feeders, inflict very painful bites, irritating to host. Swarm onto livestock and cause considerable annoyance, blood loss and create possibility of secondary infection of sores produced by their bites.
<b>Face fly</b>	Strictly in freshly excreted manure in pasture areas.	Abdomen black longitudinal with orange base (☼); thorax gray with black base and dorsal stripe (☼); thorax gray with 4 dark, lengthwise stripes; 6 to 8 mm long.	Sponging	Feed on mucus secretions of the eyes, nose and mouth of cattle and horses. Vectors of pinkeye-causing bacteria and intermediate hosts for eyeworms of cattle.
<b>Horn fly</b>	Exclusively in undisturbed, fresh manure.	Brownish-gray to black with yellowish cast to body; set of parallel stripes just behind head, brownish-red antennae; 3.5 to 5 mm long.	Chewing	Harassment. Blood-feeding resulting in blood loss.

The **face fly** (*Musca autumnalis*), is another filth fly of concern to animal agriculture. Maggots of this fly develop strictly in freshly excreted manure in pasture areas. Consequently, the adult female flies frequent pastures where they feed on the mucus secretions of the eyes, nose and mouth of cattle and horses. Their mouthparts consist of

small teeth-like structures which they use to damage eyes to increase tear secretion. Owing to their feeding habits and behavior, these flies are important vectors of the bacteria causing pinkeye and are also intermediate hosts for eyeworms (*Thelazia* spp.) of cattle. Face flies usually only visit an animal for about 30 minutes per day and spend

the rest of the time in the environment near their animal hosts. Face flies are more difficult to control than horn flies because they may feed on other protein sources besides facial secretions so that treating the animals doesn't necessarily mean effective fly control. Some insecticides for use in backrubbers or as sprays or facial smears are approved for use on lactating dairy cattle.

Another pasture fly which occurs in Michigan is the **horn fly** (*Haematobia irritans*). It has been estimated that this species is responsible for more loss to beef cattle production in the U.S. than any other single species of arthropod pest. Females lay eggs exclusively in undisturbed, fresh manure. Larval (maggot) development proceeds rapidly but depends upon ambient temperature. Both sexes of this fly bite cattle for blood. The harassment caused by blood-feeding and blood loss causes reduced weight gains and lowered milk production in cattle. Horn flies, unlike the other filth flies associated with cattle, stay on the animal where they may feed 20 to 30 minutes per day, leaving only to lay eggs. Horn flies will congregate on the animals back and head. Bulls generally have more flies per animal than do cows and young stock. Horn flies are the biological vector of *Stephanofilaria stilesi*, a parasite of cattle and cause of stephanofilariasis, a skin inflammation of the lower abdomen of cattle.



Horn flies on the back of cattle.

## MANAGEMENT OF FILTH FLIES

Management of filth flies must be integrated with manure management practices. The overall aim is to remove manure. If it cannot be removed, manure must be dried out so maggots cannot develop. **Good farm sanitation** such as regular removal of manure from confinement settings, composting, thin spreading to facilitate drying, liquefaction or other techniques can greatly reduce fly problems and are critical in a successful pest management program.

Indoor areas where animals frequent or are stalled must be kept clean of accumulating waste. House fly and stable fly development requires wet or moist conditions, thus eliminating standing water and providing good drainage are very important. Stacked manure can be covered with dark plastic to heat it, causing drying which kills fly eggs and maggots. In swine production areas, high pressure sprays can be used to clean and remove material accumulating at the waste pits. Areas along fence lines and boundaries that are difficult to keep clean will breed large numbers of flies. Obviously, manure management practices cannot be utilized effectively in pasture settings where manure pats are naturally dispersed.

Insecticides can be used effectively for adult fly control as space sprays, residual sprays, ear tags, feed additives or direct application to animals as dusts, pour-ons or wipes.



Ear tags help protect the animals from adult fly attacks.

**Space or area sprays** as mist, fog or ultra-low volume applications, typically control flies only at the time of application and for a limited area. A mist blower, fogger, ultra-low volume sprayer or hydraulic sprayer type equipment is required. Area sprays are usually mixed with water to dilute them from high concentrates (25-50%) to low concentrates (0.15-1.0%) before application. The insecticide label gives instructions on proper dilutions.

**Residual sprays** for filth flies are typically emulsifiable concentrates or wettable powders (both mixed with water, as indicated on the label, before use). They are applied as a wet spray to surfaces or vegetation where flies rest. In contrast with area sprays, which offer no residual activity, this approach offers some residual activity.

**Larvicides** have had limited success in killing maggots in manure or animal waste, so this control measure is not generally recommended. In cases where the use of larvicides is the only option, then apply labeled rates as a coarse spray.

**Insecticide-laden baits** can be used for managing house flies. Baits can be purchased ready-to-use or prepared as bait stations with residual insecticides mixed with sugar and put in burlap or paper bags. Baits are useful in indoor settings. When baits are used, place them so that animals or children cannot come into contact with them. Besides baits, certain traps can be used for fly control. Sticky traps made of stiff paper or a fiberglass panel coated with either insecticide or a sticky glue will attract stable flies and offer localized control. Jars baited with fish heads or other smelly materials typically attract green blow flies and do not control house flies or stable flies.

**Feed additives** can be used for control of maggots in manure. The additives are mixed with animal feed or provided in a salt block. The specialized insecticide moves through the animal's digestive system and later comes into contact with the maggots. Because house flies and stable flies breed in materials in addition to manure, feed additives are not completely effective unless combined with other control measures.

Certain insecticides can be **directly applied onto animals** according to label directions to protect them from flies. The insecticide applications are dips, wet sprays, pour-ons (typically along the midline), dusts applied directly onto the animal or indirectly with a dust bag and mixed with oil and saturated in a back rubber. In addition, insecticide-impregnated ear tags can be used. In each case, the specific application depends upon the target insect pest and the species and condition of the animal. Many restrictions apply to insecticide applications on young animals, lactating mothers, milking dairy cows, recently freshened cows, or those due for slaughter. Read and follow all label precautions and directions carefully.

Fly control in dairy parlors and milk rooms requires special care. Dairy farmers should control flies to prevent contamination of milk, but only certain insecticides may be used in dairy settings as directed on the labels. Generally, baits at stations or in bait sprays, or diluted space or

residual sprays are acceptable. An example of a mechanical pest control for flies is an electronic "bug-zapper" with ultraviolet lights. These devices provide limited reduction in fly numbers in indoor areas.

Certain "biological control" agents, such as predators, parasites and pathogens of the immature stages of filth flies can be integrated with other control methods. These agents work best in warmer, southern states or indoors where they can overwinter. In northern states, these agents are mainly experimental. Obviously, any use of biological control agents such as fly parasites of the fly pupae is useful when combined with other physical, cultural and insecticidal methods. Some parasites can be purchased commercially.

## BOT FLIES

Bot flies, also called **warble flies** or **gad flies**, are important, common parasites of horses, cattle, sheep and potentially foxes and mink in fur farms. Additionally, bot flies are common parasites of wild rodents, deer and rabbits, as well as other wild mammals. Infestation of bot flies in animals occurs when the larval stages are living inside the skin or tissues of the animal. This kind of fly infestation is called **obligatory myiasis** (pronounced my-EYE-ah-sis). Other kinds of flies may be attracted to and lay eggs in wounds or injuries on animals causing a kind of infestation called secondary or **facultative myiasis**.

The major bot flies or warble flies of concern are those affecting horses, sheep and pastured cattle. Table 6.4 lists these bot flies and their hosts. Figure 6.4 is an example of a bot fly adult, egg and larva. The bot flies affecting horses involve three different species that all affect the stomach, i.e., larval bot flies are internal parasites. Adult flies (large bodied with big heads) lay eggs directly on the horses.

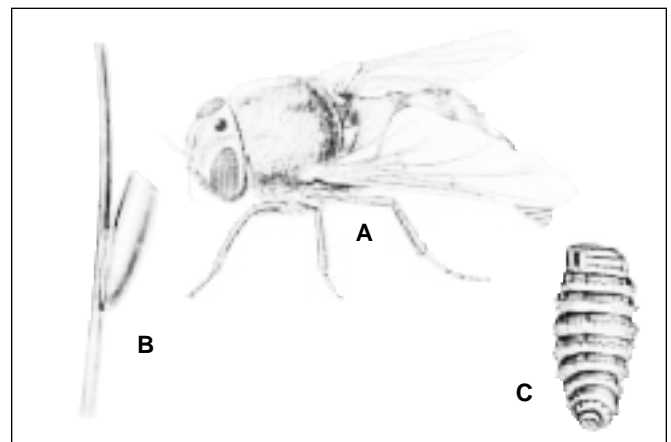

Figure 6.4 Bot fly. a. Adult bot fly. b. Egg of common horse bot fly attached to hair. c. Larva or grub of a bot fly.

**Table 6.4 Bot flies affecting domesticated animals in the United States.**

Host Animal	Common name	Scientific name
Horse	Common horse bot fly	<i>Gasterophilus intestinalis</i>
Horse	Throat bot fly	<i>Gasterophilus nasalis</i>
Horse	Nose bot fly	<i>Gasterophilus haemorrhoidalis</i>
Sheep	Sheep bot fly	<i>Oestrus ovis</i>
Cattle	Common cattle grub	<i>Hypoderma lineatum</i>
Cattle	Northern cattle grub	<i>Hypoderma bovis</i>

The **common horse bot fly** lays yellow eggs that stick to the hairs on a horse's legs. When a horse licks the legs during grooming, the eggs hatch and the new larvae enter the horse's mouth. The larvae burrow into the mucous membranes of the tongue and remain there for two to four weeks. Then, the larvae leave these tongue galleries, move to the stomach and attach themselves to the lining. The larvae detach from the stomach after a year and pass out of the animal with the feces, landing on the soil where they pupate.

The life cycle and behavior of the **nose fly** or **nose bot fly** is similar to that of the common horse bot fly. However, the nose bot fly lays its eggs, which are black, directly on the animal's nose. The bot larvae hatch in two to four days and burrow into the lip membranes and tongue, remaining there for five to six weeks. They then migrate to the stomach and remain attached to the stomach wall through the winter. In early spring, the full grown larvae detach from the stomach and reattach near the anus before finally dropping to the ground and pupating.

The **throat bot fly** or **chin fly**, of horses has a life cycle and behavior similar to the common horse bot fly and the nose bot fly. However, the female lays eggs on hairs under the horse's jaw. Larvae hatch in three to five days, crawl to the mouth and burrow into the gums, remaining there for four weeks. The mouth can be severely irritated. Afterwards, the larvae migrate to the stomach and form clusters.

The egg-laying activity of the nose bot fly and chin fly is called "**fly strike**." Fly strike greatly

disturbs horses causing them to toss their heads in panic. This behavior is a likely sign of bot fly activity.

Control of bot flies on horses involves applying insecticides by sponge or wet spray directly to the eggs. It is best to use a sponge when applying to the nose and face, to avoid spraying the mucous membranes. Bots in the stomach can be killed with orally-administered insecticides or drugs. The drugs are usually formulated as a paste applied by a syringe to the mouth of the horse. Consult a veterinarian for recommended rates and application methods.

The **sheep bot fly** (also called the sheep nose fly, sheep gadfly, or sheep head maggot) lays newly hatched, live larvae on the nostrils of sheep. The larvae crawl into the nose and eat mucus. Later, the larvae crawl into the sinuses, attach to the walls and continue to feed. Finally, larvae drop from the nostrils and pupate in the soil. Maggots of the sheep bot fly can damage the nasal tissue and infestations may result in secondary infections. An ivermectin formulation is registered for control of sheep bot flies.

The two bot flies affecting cattle are the **common cattle grub** and the **northern cattle grub**. The adults resemble bumble bees and have been called **bomb flies** or **heel flies** because when they lay their eggs they strike the legs of cattle. Cattle panic when this happens and may show **gadding** behavior by stampeding, bunching together, or standing in water. These fly eggs hatch in four days. The larvae or grubs crawl into the skin through hair follicles and migrate through the



body. The common cattle grubs migrate to the gutt and the northern cattle grubs migrate to the spinal column. In these areas, the grubs feed and develop. They then migrate internally to the back of the cattle where each grub forms a pocket or **warble** between layers of skin. The warble has an opening to the air allowing the grub to breathe. They feed on skin secretions in the warbles for months before leaving through the breathing hole and dropping to the ground to pupate. The northern cattle grub generally leaves the host from four to six weeks after the common cattle grub.

In northern states, warbles usually appear on native cattle between September and January. Warbles will appear at different times in cattle that are shipped in from other states or Canada.

Cattle grubs can be controlled by applying systemic insecticides during the fall weaning, usually between mid-September and November 1. The insecticides for grub control are available in several formulations— ready-to-use pour-on, wettable powder, feed additive, mineral block, spray and ready-to-use spot-on solution. Pour-ons and spot-ons are applied to the animal's midline, usually in one dose, but sometimes repeat applications may be done following label directions. Some of the insecticides used for grub control in the fall are also registered for cattle louse control; thus grub and louse control can be achieved with one application.

Do not treat cattle for grubs between November and January because of the possibility the dead grubs release a toxin which may cause swelling of the esophagus and spinal column.

**Other flies affecting sheep.** Sheep can be afflicted with two other kinds of flies. **Wool maggots** are one kind of blow fly that lay eggs in the wool of sheep. These flies lay their eggs in areas where the wool is soiled with urine, blood or manure, typically around the tail. Applying 0.05% permethrin spray to this area can rid sheep of the wool maggots. Many cultural practices have evolved in sheep production systems to help prevent soiling of the wool. Some practices include "crutching" (the removal of the hair below the tail and between the legs) and "docking" (the removal of the tail). Reducing the possibility of injury and keeping the animals dry and clean are of greater value in wool maggot management than chemical treatment.

Sheep also harbor an odd ectoparasite that resembles a tick, called the sheep ked. The ked is actually a wingless, blood-feeding fly. Ked control is important, otherwise infested sheep can suffer blood loss and other debilitating conditions. Ked control can be accomplished in a manner similar to louse control on sheep (see Chapter 4).



Sheep ked: pupae.



Sheep ked: adult.

---



## Chapter 6 – Review Questions

**Write the answers to the following questions and then check your answers with those in the back of this manual.**

1. How many pairs of wings do flies have?
  - a. None
  - b. One
  - c. Two
  - d. Three
2. What are the three groups of fly pests of animals?
3. What do the immature stages or larvae of flies look like?
  - a. Seeds.
  - b. Flat disks.
  - c. Caterpillars.
  - d. Maggots.
4. Name three of the blood-feeding flies.
  - 1.
  - 2.
  - 3.
5. Which of the blood-feeding flies has a developmental cycle involving water or aquatic habitats?
  - a. Mosquito.
  - b. Stable fly.
  - c. House fly.
  - d. Horn fly.
6. Dog heartworm is caused by a nematode and is transmitted between dogs by mosquitoes. (True or False)
7. What are the three components to biting fly management?
8. What important ecological role do filth flies fulfill?
9. Some filth flies are vectors of disease agents to animals and humans. (True or False)
10. What is the difference between a space or area spray and a residual spray?

---

## CHAPTER 7

# HOST ANIMALS AND THEIR PESTS

### LEARNING OBJECTIVES:

After you finish studying this chapter you should be able to:

- Identify the primary arthropod pests of livestock in Michigan.
- Determine where specific pests are likely to be located on the host animal or bird.
- Monitor for pest injury or the presence of pests on host animals.
- Identify behavior of animals that may indicate the presence of pests.

---

The previous chapters presented information on groups of arthropods including identification, biology, their impact on animal hosts, and how to detect and manage them. This chapter provides a profile of the primary livestock groups in Michigan and reviews the arthropod pests that are associated with them. The livestock profiles include dairy cattle, beef cattle (confined or pasture), swine, sheep and goats, horses, and poultry. This information is intended as a summary focusing on the animal host. Refer to the previous chapters for detailed information on the individual arthropods.



### DAIRY CATTLE

Dairy cattle maintained in typical dairy herd production systems (milk parlors, barns, drylots, loafing sheds, and pastures) are inflicted by house flies, stable flies, horn flies, face flies, mosquitoes, horse and deer flies, heel flies or cattle grubs, lice, and mites. The importance of these arthropods to animal health and to milk production, and to the corresponding monitoring and management practices required, depends upon the sex and age of the animals and their stage of management (e.g., first-year heifers on pasture vs. confined, freshened cows). For example, horn fly

and face fly will generally only be significant pests on cows and bulls in pastures and some drylots. Different arthropod pest activities vary seasonally, thus monitoring efforts must be adjusted accordingly.

### Pest: House Flies

House flies are very common in dairy operations because the larvae or maggots occur in waste material such as manure. They are common summertime pests in feedlot and dairy barns. In large numbers, they annoy animals and people. Also, the flies may function as mechanical transmitters of some disease-causing microorganisms.

**Monitoring:** House flies can be monitored using fly speck cards or by visual inspection of the premises and animals.

**Management:** Sanitation is the primary management strategy for house flies. Use of insecticides to reduce fly numbers to more desirable, lower densities is a secondary strategy. Insecticide use includes premise sprays as residual treatments, space sprays, and animal feed-throughs. Use of insecticides to control maggots, other than feed-throughs, is not recommended.

Another management strategy includes the release of parasitic wasps which attack the immature stages (especially pupae) of house flies. This *biological control strategy* must be used in conjunction with sanitation and must be customized to local climates and conditions.

## Pest: Stable Flies

Stable flies are biting flies, similar in appearance to house flies.

**Monitoring Activities:** These flies can be monitored by looking for the biting individuals on the bodies of animals, especially the legs, or by using sticky traps made of Alsynite panels covered with adhesives to capture the flies. Threshold densities of stable flies for control decisions have not been established.

**Management:** Any level of animal annoyance and discomfort should instigate fly management actions. Stable fly management requires good sanitation in the animal's environment. Maggots of stable flies occur in wet, decaying materials such as urine-soaked straw, wet, spilled feed, and straw-manure mixtures. Calf pens can attract and be a significant source of stable flies and house flies. Bedding in animal beds must be cleaned out and then replaced with fresh material—not merely be covered over with fresh material. Eliminate breeding sites to greatly reduce stable fly populations. Other stable fly management methods include those discussed for house flies—premise sprays as residual treatments, space sprays, and animal feed-throughs.

## Pest: Horn and Face Fly

Both the horn fly and face fly occur in open, pasture settings and secondarily in drylots. These flies rest and feed directly on the animals. Horn flies are blood feeders and bite the host animal several times per day. Face fly feeding activity injures the eyes and introduces pink-eye bacteria. The females of both flies lay their eggs in freshly-voided manure.

**Monitoring:** Watch for peak populations of horn and face flies by late spring/early summer. Face flies are present throughout the season. Make visual inspections of the animals for the resting and feeding horn and face flies. Horn flies rest and feed along the backline of adult animals. Face flies aggregate on the face of the animals, feeding on eye secretions of both calves and cows. Also, watch for fly avoidance behaviors by the animals, such as when groups of animals bunch together to avoid fly strikes. Some studies suggest that these flies cause decreased milk production or decreased feeding efficiency. Thresholds to assist in management decisions for these flies have not been established for dairy cows but consideration of annoyance and discomfort of the animals are critical factors when deciding on management action.

**Management:** Horn fly management includes applying insecticides directly to the animal, either

as a pour-on, dust, spray, or insecticide-impregnated ear tags and supplemented with dust bags. For face fly management, options are limited but include the use of insecticide-impregnated ear tags attached to the animals and encouraging animals to move against dust bags, oilers and back rubbers that contain insecticides effective against the flies.

## Pest: Biting Flies

Mosquitoes, black flies, midges, and deer and horse flies are all biting flies that are primarily pests of outdoor animals, especially those on pasture.

**Monitoring** for these pests is through direct examination of the animals. Presence of these biting flies on their bodies, and observation of abnormal animal behavior are indicative of annoyance by biting flies.

**Management:** Reduce biting fly problems by moving animals indoors where they are protected from biting insects. Biting flies can be managed with insecticides applied on the animals.

## Pest: Cattle Grub or Heel Fly

The **cattle grub** or **heel fly** (two species of flies in northern states called the common cattle grub and the northern cattle grub) are pests of pastured heifers and other pastured dairy cows. The adult flies are active from spring to early fall and lay eggs on the body of the cows. The eggs hatch into larvae or grubs that burrow into the host animal. The grubs migrate through the body for several months before establishing warbles in the skin along the back. Cattle grubs damage the hide and cause deterioration of cattle condition.

**Monitoring:** Management of cattle grubs begins with monitoring the pastured animal's behavior. Kicking of their feet (gadding) and running about is evidence that they are attempting to escape buzzing, striking flies. The pest is known as a heel fly during this stage because they lay their eggs around the animal's heels, although some eggs may be laid on the belly. If producers witness this activity, expect grubs to appear in the animals in the fall. In fall, inspect cattle by feeling along the spine, especially of young animals, to detect the grubs in elevated areas of the skin called *warbles*. A hide with five or more warbles is downgraded.

**Management:** Successful control of this pest requires community-wide management. To kill the grubs, use a systemic insecticide or injectable drug. Make these applications or treatments before a fall cutoff period, when the grubs are around the animals' esophagus or the spinal cord. Grubs killed after the fall cutoff date may cause inflammation

**Figure 7.1 Common Pests of Cattle**

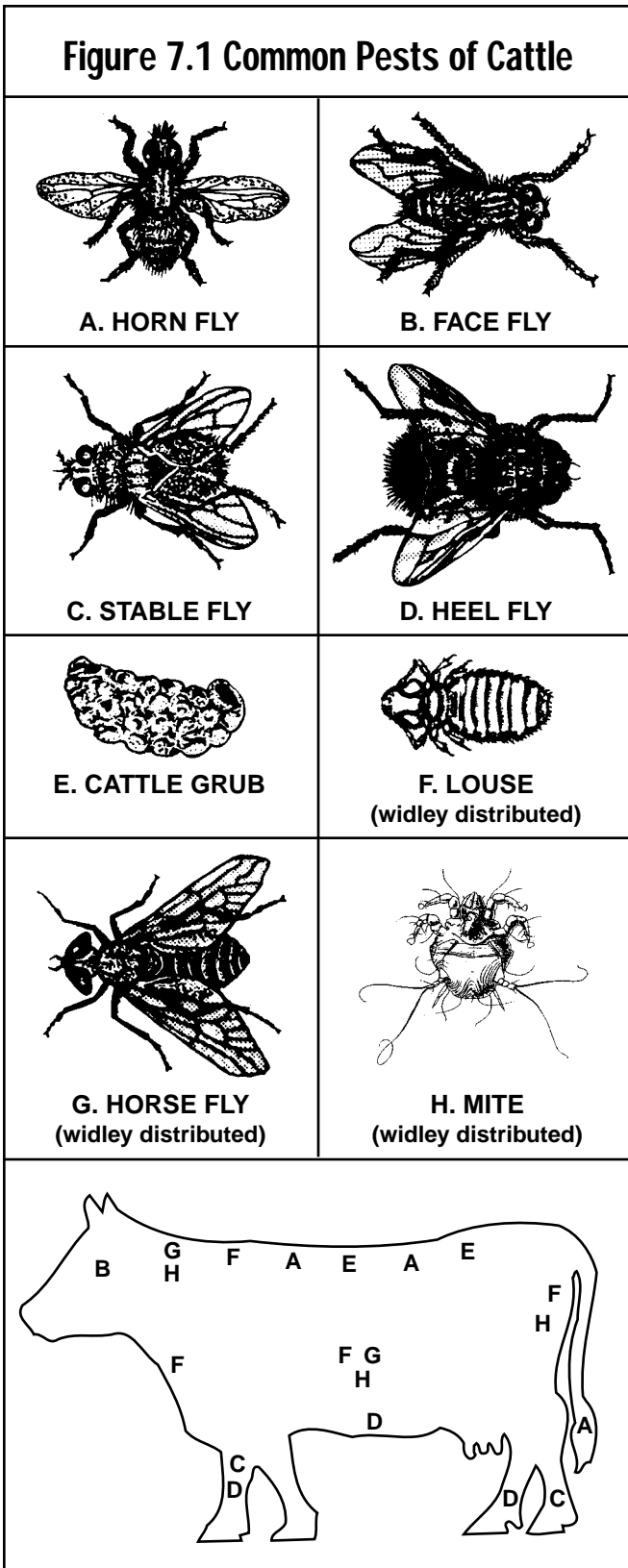

resulting in choking or paralysis of the host animal. Check with a veterinarian or other authority for the cutoff date in your area. In Michigan, treatment is typically before November 1.

## Pest: Lice and Mange Mites

Dairy cattle may become infested with lice and mange mites particularly in the winter.

**Monitoring:** Observing the animal's general condition—coat appearance, presence of skin lesions—provides indications of lice or mite infestations. Animal behavior—excessive licking and scratching and rubbing against structures—also indicates the pest presence. Producers should monitor for eggs or lice and mites on a regular basis throughout the winter. Part the animal's hair and examine the hair and skin for the eggs and adults of these pests. Skin scrapes are more useful than surface examinations for determining the presence of burrowing mites.

**Management:** To prevent the spread of these pests, quarantine and monitor new animals before integrating them with existing herds. Oversee, separate and treat infested animals to prevent establishment of mange mite populations in herds.

Insecticides applied as high pressure sprays, pour-ons or dusts are the chemical approach to lice and mange mite control. For lice, two pesticide treatments at weekly or biweekly intervals may be necessary. Pesticides are not effective against eggs therefore, a second application is needed to kill the lice that hatch after the first treatment.

Sarcoptic mange management requires acaricide applications to control the mite as described in the mite and tick chapter. Pesticide treatments to lactating and nonlactating animals are different. Be sure to follow all appropriate precautions. Mites other than sarcoptic mites, can be controlled with the types of insecticide treatments used for lice.

For all arthropod pests of dairy cattle, it is extremely important to use treatments that conform to regulations regarding withholding times and residue tolerances for milk. Some treatments may be acceptable for nonlactating cows and for beef cattle, but may not be acceptable for milk cows. Use of many systemics is prohibited for milking cows. Consult veterinarians, dairy extension specialists, and pesticide labels for information about restrictions and rates of applications.

## CONFINED CATTLE

The arthropod pests of confined beef cattle are similar to those that inflict dairy cattle. Manure management strategies which are important to reduce pest pressures will differ because of the different housing and operational conditions between confined beef cattle and dairy cows. For

example, sanitation and maintenance of fly-free conditions in milk parlors is critical but does not reflect the low level but tolerable fly thresholds in beef cattle environments. Confined beef cattle are generally not bothered by the open pasture fly pests—horn fly and face fly. Although, these flies occasionally become problems on feedlots (especially face fly on steers and horn fly on isolated bulls). Grubs may be a problem in confinement if the cattle are brought in from pasture or range for finishing rations. The other arthropods (house fly, stable fly, lice, and mites) can be important pests in confined beef cattle operations. Monitoring and management activities for the pests of confined beef are the same as for dairy cattle listed above.

## RANGE AND PASTURE CATTLE

The arthropod pests of pastured or rangeland cattle differ somewhat from dairy and confined cattle. Horn flies and face flies are more important than house flies and stable flies. Biting flies, such as deer flies and horse flies, are relatively important pests of range and pasture animals. Cattle grubs are also important pests of pastured cattle. Lice and mange mites may infest pastured cattle as well. In some areas, ticks are serious pests of rangeland cattle. Monitoring and management methods for arthropod pests are similar to those described for the dairy and confined cattle.



## SWINE

### Pests: Hog Louse and Mange Mites

The primary arthropod pests of swine are the hog louse and mange mites. Both of these pests are obligate ectoparasites on the skin of swine. Hog lice are very large (compared with other lice), and can be detected on the hog's body in clumps, particularly around the neck and ears.

**Monitoring:** Signs of excessive scratching or irritation by the animal are indications that a pest problem exists. Direct examination of the animals' skin is the best method for detecting a lice or mite infestation. Pay close attention to the neck and ear area.

Mange mites are very tiny and burrow into the skin, thus they are not directly visible. Scraping of the skin surface, especially at crusty areas where

mite infestations exist, yields a small skin sample that can be examined under a microscope to confirm the presence of mites and mite burrows.

**Management:** Hog lice and mange mite management involves sanitation through cultural methods, monitoring and pesticide treatment. Sanitation entails culling chronically-infected individuals, treatment of sows before farrowing to prevent transfer of lice or mites from sows to young pigs, purchasing louse- and mite-free hogs, and quarantining newly acquired hogs.

Direct application of high-pressure acaricides sprays onto the skin of the hogs, or use of injectable acaricides are used for mange mite control. Louse control requires similar methods. The chapter on mites and ticks discusses louse and mite control on swine in detail.

### Pest: Flies

House fly and stable fly populations occur in association with animal waste and other waste materials at swine operations. Biting insects such as mosquitoes and deer flies, also bite and annoy hogs.

Figure 7.2 Common Pests of Hogs

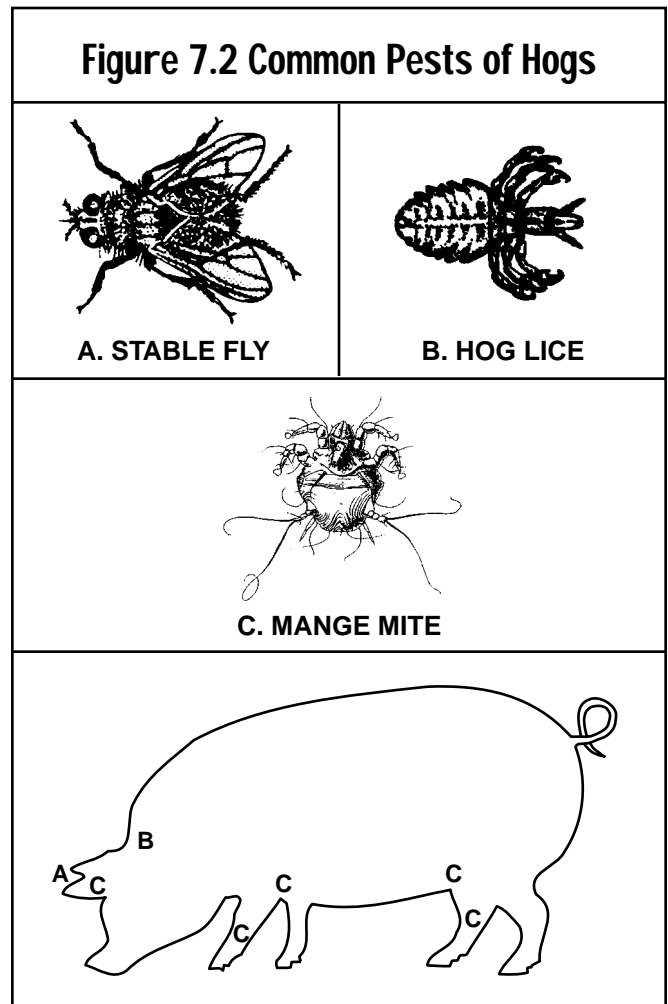

**Monitor** and employ general fly management activities—sanitation, as used in confined cattle operations. See the appropriate management options for biting flies described for cattle and in chapter six, “Flies.”

## Pest: Fleas

Fleas can be pests of hogs when populations become established in confined, production facilities. The adult fleas spend most or all of their time on the animal, while the larval fleas live in the bedding material and cracks and crevices near where the hogs are confined.

**Monitoring:** Watch the animals for excessive scratching and rubbing. Directly inspect the animal’s bodies for adult fleas.

**Management:** Control fleas with sanitation efforts—eliminate eggs, larvae and larval habitat. If large populations exist, crack and crevice and premise sprays of insecticides may be necessary to bring the problem under control.



## SHEEP AND GOATS

The arthropod pests of sheep and goats include flies associated with manure, as well as arthropods that either blood feed on these animals, annoy them, or infest their wool, skin or other tissues. Sheep have a larger number of pests than goats.

## Pest: Biting flies

Mosquitoes, deer and horse flies, and biting midges can severely affect sheep and goats.

**Monitoring:** Watch for biting fly activity around the animals. Presence of biting *stable flies* on animals indicates that improved sanitation is required to reduce fly numbers.

**Management:** Due to their association with manure and waste materials such as wet straw, large stable fly populations can develop among sheep and goats, in and around barns and out-buildings. House flies may also occur because of accumulated manure from sheep and goats. Improve manure sanitation measures to reduce stable fly and house fly populations.

## Pest: Lice

A variety of lice occur on both sheep and goats. Lice are a minor problem on goats compared to sheep. Their impact varies with the general health and condition of the individual animals, the type of lice, and the nature of the wool fleece — fine or thick.

**Monitoring:** . Most lice are problematic in the winter months with the exception of the foot louse. Foot louse is most abundant in warmer months. Animals with a ragged fleece, and those that are rubbing and scratching excessively, are likely to be heavily infested. Make several spot checks over the animal’s entire body. Locate lice by parting the wool and examine the base of hair next to the skin. The location of the lice may help with identifying the lice species.

On sheep, the sheep biting louse is most common and is widely distributed over the body. The foot louse is usually contained on the animal’s legs. Face and body louse are on all parts of the body except the limbs. When populations are low, the face and body louse is only on the face.

On goats, the goat biting louse is widely distributed as is the Angora biting louse specifically on Angora goats. The face and body louse is on all parts of the body except the limbs. Low level populations of the face and body louse are only found on the animal’s face.

**Management:** Apply low pressure insecticide sprays and dusts for control of sheep lice. A detergent in the spray increases the sticking ability of the insecticide. Shearing removes lice populations from the animal.

## Pest: Sheep Keds

Sheep keds are wingless, blood-feeding flies similar in appearance to ticks. Their feeding deprives the sheep of nutrition. They are rarely pests on goats.

**Monitoring:** Sheep keds can be found throughout the year in sheep wool. Blood-feeding by the keds stains the wool and provides evidence of their presence. Inspect the belly and neck by parting the wool to detect sheep keds.

**Management:** Apply insecticide to each individual in the entire flock to effectively reduce sheep keds. The appropriate method of insecticide application depends on flock size and the availability of facilities and labor. Dips, sprays, dusts, and pour-ons are all acceptable methods of application. Shearing removes sheep keds from the animal.

## Pest: Mange Mite on Sheep

The primary mange mite of importance on sheep is the non-burrowing mange mite (*Psoroptes ovis*). It infests the skin and causes a condition called sheep scab. Other mites of the *Chorioptes* group also infest sheep. Mange mites are a problem throughout the year.

**Monitoring:** Detect mite infestations by looking for signs of sheep scab—shabby appearance of the fleece, excessive scratching and rubbing. Take skin scrapings and make microscopic observations to determine mite presence. Cull the chronically infected individuals to prevent transmission to non-infected animals.

**Management:** Dipping with approved acaricides is the preferred mite management method for sheep.

## Pest: Wool Maggots on Sheep

Wool maggots are fly larvae that hatch from eggs laid in the waste and moisture that accumulates around the tail and hind legs of sheep. Adult wool maggots are blow flies. The maggots invade the fleece and can cause skin injury.

**Monitoring:** Adult wool maggot flies are active in the summer. They are attracted to soiled animals and lay their eggs in soiled wool. Inspect sheep for wool maggots by examining wool at the breech and look for manure-laden tags of wool that harbor maggots.

**Management:** Keep animals clean. Combine shearing with early season lambing (to remove the breech of ewes that becomes contaminated with birthing material) to prevent wool maggot occurrence. If infestations occur, local or spot treatment of infestations with insecticides is an effective management method.

## Pest: Sheep Bot Fly

Maggots of the sheep bot fly (or head grubs) live in the nostrils of sheep, feeding on mucus. The adult flies lay live larvae (not eggs) into the sheep's nose.

**Monitoring:** Sheep hold their heads low or in a corner to escape the striking behavior of flies. Fly activity occurs throughout the summer. Observe sheep behavior and inspect for presence of grubs in the nostrils.

**Management:** Ivermectin drenches control sheep bot fly problems.

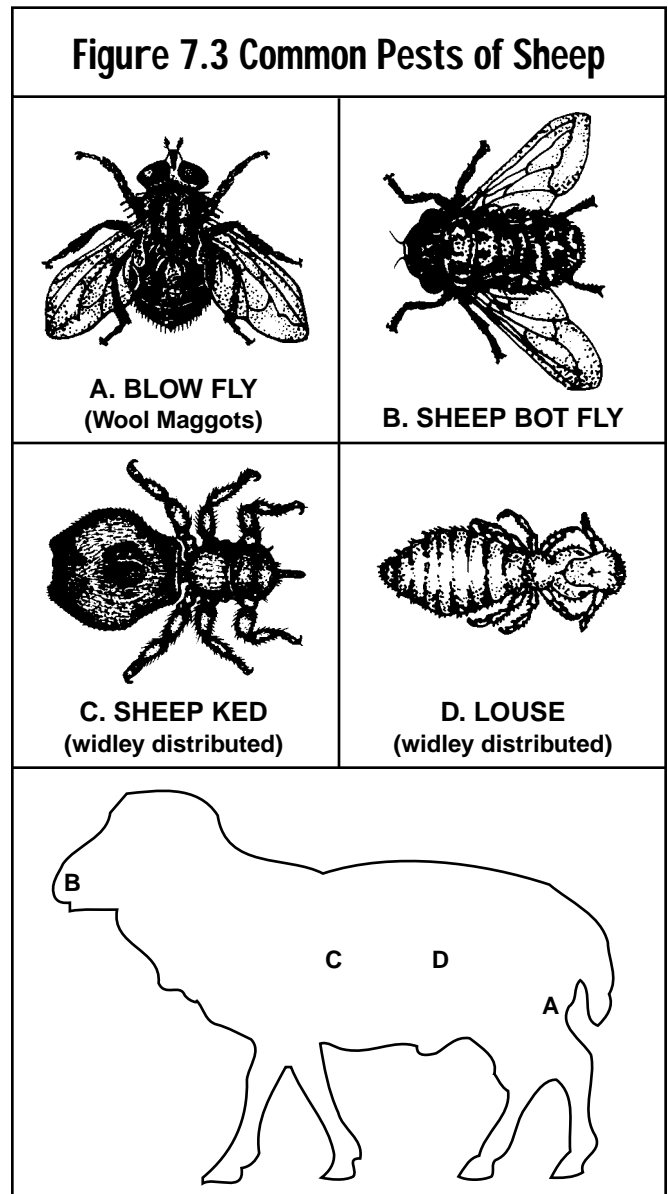

## HORSES

The arthropod pests of horses include biting flies, nonbiting flies, bot flies, lice and mange mites.

## Pest: Biting Flies

Biting flies such as mosquitoes, deer and horse flies, black flies, and biting midges are very important pests of horses, particularly those that are pastured. Monitor and control biting flies using the methods described for cattle above.

The stable fly is associated with manure and waste materials such as wet straw. Large populations develop in poorly maintained horse



barns and stables. Presence of biting stable flies on animals indicates that improved sanitation is required to reduce the numbers of flies.

**Monitoring:** Directly observe the bodies of the horses for presence of the biting flies. Also, observe the horse's behavior watching for signs of irritation and annoyance caused by the flies.

**Management** of biting flies varies with the kind of fly. Consult chapter six, Flies for this information.

### Pest: Filth Flies

Filth flies, such as house flies, occur because of accumulated manure. Reduce manure to reduce house fly densities and their annoying activities.

Sometimes, face flies are attracted to horses and use them as hosts. Horses kept in pastures are at greatest risk.

### Pest: Bot Flies

The bot flies affecting horses involve three different species. All species affect the stomach. The adult flies lay eggs directly on the horses, either on the legs, nose or on hairs under the horse's jaw. Larvae hatch in three to five days, crawl to the mouth and burrow into the gums, lips or tongue. After a period of development, the larvae migrate to the stomach. The burrowing activity of the larvae is very irritating to horses, and the presence of bots in the stomach can disrupt digestion and cause other problems.

**Monitoring:** Adult bot flies are active throughout the summer. Observe horse behavior during "fly strike" (when the flies are laying their eggs). Examine the horses for wounds in the mouth and presence of eggs.

**Management:** Apply insecticides by sponge or wet spray directly to the hair coat to kill the bot fly eggs. If wounds are found in the mouth, contact a veterinarian for further assistance with bot fly control. Bots in the stomach are controlled with orally-administered insecticides or drugs. The drugs are often formulated as a paste applied with a syringe into the horse's mouth.

### Pest: Lice and Mange Mites

Both lice and mange mites infest horses.

**Monitoring:** For both lice and mange mites, inspect the horse's hair coat for these pests, or for signs of damage caused by them. Also, a general deteriorated condition of the animal can be an indicator of infestation by lice or mange mites.

**Management:** Routine grooming reduces the chance of lice or mite populations from becoming

established. Control existing lice and mites by rubbing or brushing appropriate acaricides or insecticides into the hair coat, and treating tack, saddles and blankets. Mites are more difficult to kill than lice.

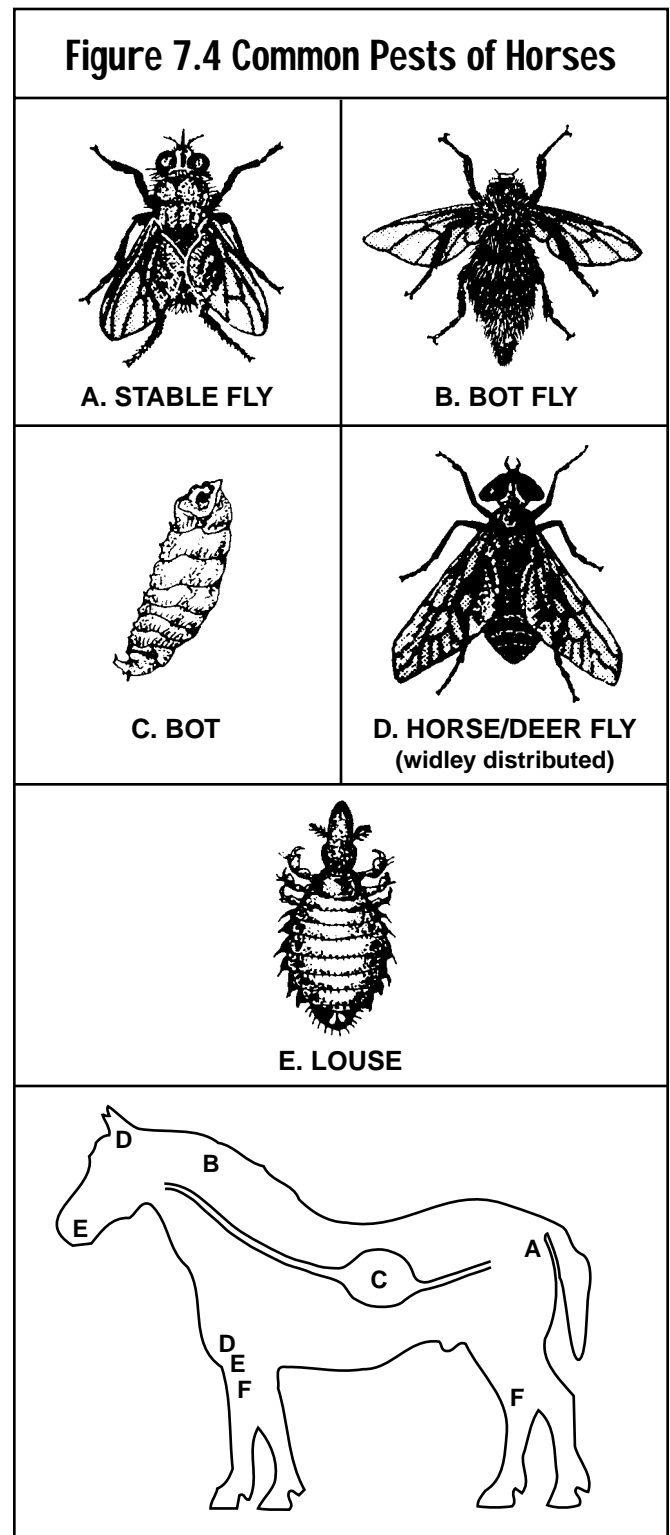



## POULTRY

The arthropod pests of poultry that infest the bodies of the birds include bed bugs, ticks, lice and mites. Annoying insects associated with accumulated manure, such as filth flies, are potential problems in poultry operations (humans may be more annoyed than the poultry). Darkling beetles may invade the structure of poultry facilities.

### Pests: Northern Fowl Mite

The northern fowl mite infests the bodies of birds, and also occurs in nests and houses. The mites are active night feeders. The mites suck blood, creating wounds which develop into dermatitis that can further become infected with bacteria.

**Monitoring and detection:** Northern fowl mites are active throughout the year. Examine the vent area of potentially-infested birds for presence of darkened feathers which is caused by dried blood. The mites may also be seen. Monitor the birds regularly (biweekly).

**Management:** Prevent the introduction of mites by eliminating infested birds and taking precautions to integrate only pest-free birds. Once mites have become established, use of cultural practices to reduce mite habitat and to prevent transfer of mites from infested to uninfested areas is important.

Acaricides are an important element used in mite management. Poultry must be sprayed thoroughly with a high power sprayer. Liquid pesticides are preferable to dusts for northern fowl mite management. The premise may also require pesticide treatments to rid the building of northern fowl mites.

### Pests: Lice

Many species of lice infest chickens and turkeys, but the species of most concern is the **chicken body louse**. Body lice feed on skin scales.

**Monitoring:** Body lice on chickens are found close to where the feathers meet the skin. The eggs appear as white clusters on the feather shafts, while the lice are yellowish-white and can be seen on feathers and skin. Poultry lice are usually more common in the summer than in the winter. During this time, examine the feather shafts and skin for chicken body lice and the northern fowl mite.

Management of lice on poultry requires application of wettable powder sprays or emulsifiable concentrate insecticides to the bodies of the birds, and dusts to the nest boxes and litter.

### Pest: Filth Flies

Accumulations of manure in poultry houses provide habitat for a variety of arthropods, some of which may be pests. For example, maggots of several different species of flies (filth flies) live in manure.

**Management:** Manure management is an important component of filth fly management for poultry production systems. Manure management strategies will vary with the kind of production system (layer house, broiler house, turkey house, etc.). Maintain dry manure to eliminate fly maggot habitat —moist conditions are required for maggot survival.

There are many predators and parasites of the pest insects. It is important to preserve the natural enemies of the pest insects that occur in poultry manure. Thus, avoid direct insecticide applications onto manure which kills beneficial arthropods living in it.

Figure 7.5 Common Pests of Chicken

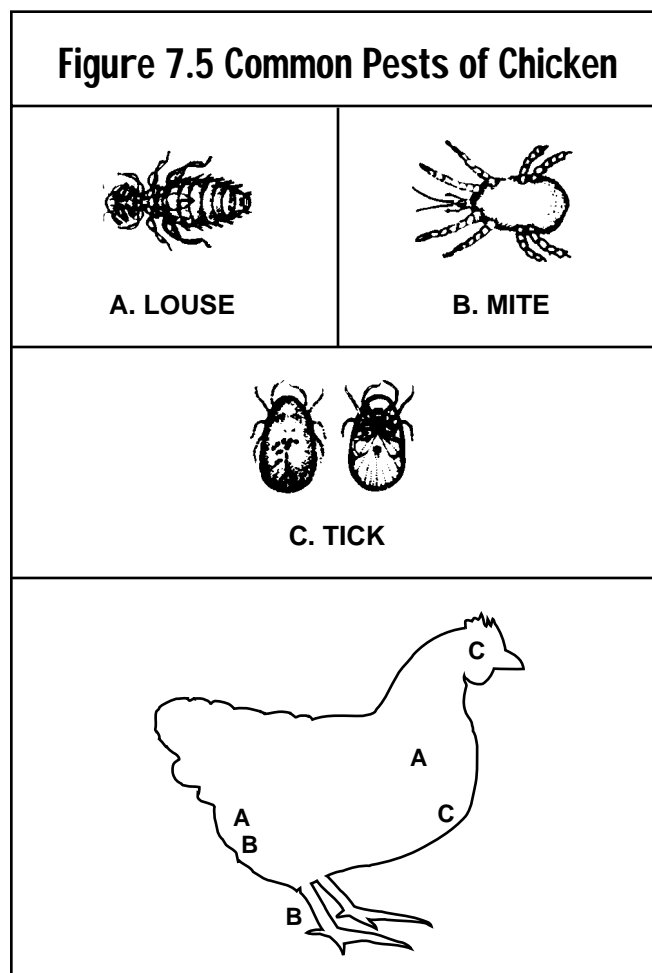

---



## Chapter 7 – Review Questions

**Write the answers to the following questions and then check your answers with those in the back of this manual.**

- Dairy cattle have lice and mange mite problems primarily in the:
  - Spring
  - Summer
  - Fall
  - Winter
- Horn and face flies lay their eggs in:
  - The animal's skin.
  - Fresh manure.
  - Pasture settings only.
  - The base of the horns.
- Confined beef cattle experience similar pests as dairy cattle. (True or False)
- The primary arthropod pest(s) of swine in Michigan is(are):
  - Hog louse.
  - Flies.
  - Fleas.
  - Mange mites.
  - A and D
- What four cultural practices reduce the spread of lice and mange mites on swine?
  - 
  - 
  - 
  -
- What part of the sheep's body should be inspected when looking for sheep keds?
  - Back legs.
  - Ears.
  - Belly and neck.
  - Along the backbone.
- Which arthropod pest requires skin scrapings and microscope-aided examination to confirm its presence in a host animal?
  - Wool maggots.
  - Mange mites.
  - Bot fly.
  - Ticks.
- The bot flies that affect horses include four different species that affect the host animals' lungs. (True or False)
- When managing filth fly populations, what is the most effective management activity?
  - Putting ear tags on animals.
  - Hanging fly strips and making premise sprays of insecticides.
  - Releasing parasitic wasps.
  - Improving manure management techniques.
- What body area on poultry should be inspected for northern fowl mites?
  - Vent.
  - Combs.
  - Feet.
  - Under wings.

---

# Answer Key to Livestock Pest Management Review Questions

## Chapter 1 – Pests and Integrated Pest Management

1. Adult insects have three body regions; head, thorax and abdomen – and three pairs of legs.
2. b
3. c
4. An organism the pest is associated with.
5. True
6. Dermatitis is direct skin damage. Inflammatory reactions of animal skin may be caused by arthropod bites, body secretions and other irritations.
7. The four groups of important animal insect pests are:
  - biting and non-biting flies.
  - invasive flies.
  - chewing and sucking lice.
  - fleas.
8. Integrated pest management—the use of all available strategies to manage pests so that an acceptable yield and quality can be achieved economically with the least disruption to the environment.
  1. Detection, 2. Identification, 3. Economic or medical significance, 4. Control method selection, and 5. Evaluation.
9. Early detection of small pests:
  - allows the manager more control options.
  - reduces animal discomfort by preventing increased pest populations.
10. Identifying the pest allows the animal manager to gather information about that particular pest (life cycle, biology) so that the pest's susceptible life stage can be targeted for control.
11. Economic injury levels are most important in agricultural settings (livestock, etc.).
12. d
13. The applicator must consider dose-response relationships and pesticide choice.
14. IPM strategies include:
  - biological** – use of predators and parasites.
  - cultural** – keep animal well groomed and its environment clean, provide adequate diet and exercise.
  - mechanical**- groom, clean regularly, use lights to attract pests away from animals, trap rodents.
  - physical** – sticky flypaper, separate animals, clean up after infested animals.
  - pest-resistant breeds** – use breeds of animal that are resistant to certain conditions and characteristics of that area.
  - sanitation** – keep kennels, barns, stables, exercise areas, and bedding clean.
  - quarantines** – isolate a new animal for a while to confirm it is pest-free; separate weak or sick animals from the herd or flock until they recover.
  - chemical**- pesticides.

## Chapter 2 – Pesticides and Their Use for Livestock Pest Management

1. e
2. False
3. b
4. Tremors, vomiting, excessive salivation, ataxia, loss of appetite, diarrhea, seizures, breathing difficulty, weakness, death.
5. Organophosphates and carbamates. A wide range of insects including fleas, ticks, mites and lice.
6. True
7. a.
8. False
9. d
10. e
11. True

12. A premise spray will persist in the treated area for a long period of time. A space or area spray does not have residual qualities and kills only the pests present at the time of application.
13. a
14. Identify the pest to be sure the product is an effective control; determine if the product is labeled for use on animals; determine if there are use restrictions for certain animals; type and percentage of active ingredient; toxicity; formulation; equipment required to make the application; requirements for retreatment.
15. Physical, chemical, host tolerance, timing and timing incompatibility. See these sections of the chapter for definitions.

### Chapter 3 – Mites and Ticks

1. b
2.
  1. by damaging tissues and causing dermatitis;
  2. by causing blood or body fluid loss;
  3. by causing allergic reactions; or
  4. by creating conditions for secondary bacterial infection.
3. e
4. Mites mate and the females lay eggs. Eggs hatch and six-legged larvae emerge. Larvae feed and molt to the eight-legged nymph. Later, after feeding, the nymphs molt and become adult male or female mites.
5. a
6. Because of their burrowing behavior and feeding.
7. True
8. True
9. False
10. a
11. True
12. True
13. In the scaly skin condition, skin thickens and wrinkles and hair falls out. Skin turns color from normal to red or bruised-looking. In the pustular skin condition, pimples or pustules filled with pus develop. The pustules can develop into severe abscesses or nodules filled

with fluid and pus. This skin condition usually develops after the scaly condition and reflects the development of secondary bacterial infections in the follicles. In both conditions, itching occurs.

14. These skin conditions are collectively called demodectic mange.
15. True
16.
  1. they cause blood loss,
  2. their feeding causes inflammation and irritation of the skin,
  3. they may stimulate hypersensitive allergic reactions,
  4. they may cause a toxic reaction in the host, complicated by paralysis (called “tick paralysis”), and
  5. they transmit microorganisms that cause disease.
17. True
18. True
19. If they are pastured animals, vegetation management can reduce tick habitat. On animals, tick control can be achieved using approved acaricides by dipping, spraying the entire animal or applying whole animal dusts. When only a few ticks are present, remove them using tweezers or fingers.

### Chapter 4 – Chewing and Sucking Lice

1. Sucking lice feed on blood. Their mouthparts penetrate the skin of an animal and they draw the food from blood vessels.
2. False
3. The head of a sucking louse is narrower than the thorax.  
The head of a chewing louse is wider than the thorax.
4. Grooming; the animal’s immune system can help protect against lice.
5. If parents, especially the mother, do not have lice, offspring will not risk infestation through exposure to the parent.
6. life cycle
7. c

## Chapter 5 – Fleas

1. True
2. An allergic condition that can be brought on by a single flea bite in an allergic or sensitized animal.
3. “Hot spots” occur when the animal continually scratches at highly inflamed sites on the skin caused by flea bites, creating conditions for bacterial infection. A hot spot is painful to the animal and may exude pus.
4. False
5. A few eggs per day and several hundred over the course of her life.
6. True
7. d
8. Treating for fleas on the host animal and in the host’s environment at the same time.
9. True
10. It is an illegal use of the products and can harm you, your family or your pets by creating dusts or fumes that could be inhaled.
11. They prevent flea larvae from developing to the adult stage.
12. Fires or explosions.

## Chapter 6 – Flies

1. b
2. Blood-feeding flies not associated with manure or animal waste.  
Filth flies associated with animal waste or manure.  
Parasitic bot flies.
3. d
4. Mosquitoes, black flies, biting midges, deer flies, and horse flies are blood-feeding flies.

5. a
6. True
7.
  1. Modification of the habitat and environment to reduce the sources of the flies.
  2. Separate animals from the flies through physical means— i.e., keep animals indoors when flies are biting.
  3. Use of repellents on the bodies of animals and insecticides applied to the animals directly or in their immediate environment where the flies occur.
8. They degrade manure to simpler components and reduce the volume of waste material.
9. True
10. Space or area sprays typically control flies at the time of application, whereas residual sprays offer longer activity.

## Chapter 7 – Host Animals and Their Pests

1. d
2. b
3. True
4. e
5.
  1. Cull chronically infested individuals.
  2. Treat sows before farrowing.
  3. Purchase pest-free hogs.
  4. Quarantine newly acquired hogs to confirm that they are pest-free.
6. c
7. b
8. False
9. d
10. a

---

# GLOSSARY

**Abiotic** – Not relating to living organisms.

**Abrasive** – Capable of wearing away or grinding down another object.

**Absorption** – The uptake of a chemical into plants, animals or minerals. Compare with adsorption.

**Acari** – Scientific grouping of organisms within the class Arachnida, including spiders, mites and ticks.

**Acariasis** – Veterinary term for an infestation of mites in or on an animal.

**Acaricides** – Pesticides that control mites or ticks.

**Acceptable daily intake** – A reference dose for the health-based standard for chemicals in food. For non-carcinogenic pesticides, it is generally 1/100 of the NOEL; for carcinogenic risk, it is 1/1,000,000 of the NOEL.

**Acidic** – Having a pH less than 7. Any of various typically water-soluble and sour compounds that are capable of reacting with a base to form a salt, that are hydrogen containing molecules or ions able to give up a proton to a base or are substances able to accept an unshared pair of electrons.

**Acre-foot** – A volume of water equivalent to 1 acre of water 1 foot deep.

**Active immunity** – Immunity (antibodies and immune cells) developed by an animal in response to a disease challenge or a vaccine antigen, as opposed to passive immunity, which is immunity conferred by the mother through antibodies ingested in the milk (colostrum). Active immunity is long-lived. Passive immunity is short-lived.

**Active ingredient** – The chemical(s) in a pesticide product that control the target pest.

**Acute effect** – Illness or injury that may appear immediately after exposure to a pesticide (usually within 24 hours).

**Acute exposure** – Exposure to a single dose of pesticide.

**Acute toxicity** – A measure of the capacity of a pesticide to cause injury as a result of a single or brief exposure.

**Additive** – A chemical added to a pesticide formulation to increase its effectiveness or safety; same as adjuvant.

**Adherence** – Sticking to a surface.

**Adjuvant** – A chemical added to a pesticide formulation or tank mix to increase its effectiveness or safety.

**Adsorption** – The process by which a pesticide bonds with a surface; e.g., a soil surface.

**Adulterated** – (1) A pesticide whose strength or purity falls below that specified on the label. (2) A food, feed or product that contains illegal pesticide residues.

**Aerobe** – An organism that requires oxygen for growth.

**Aerosol** – A suspension of very small particles of a liquid or a solid in a gas.

**Agitate** – To stir or mix.

**Agitation** – The process of stirring or mixing.

**Agitator** – Device that stirs or mixes a pesticide in a tank or hopper.

**Agricultural animals** – Those used for production of food and fiber; livestock.

**Algae** – Photosynthetic plants that contain chlorophyll, have simple reproductive structures, and have tissues that are not differentiated into true roots, stems or leaves.

**Algaecide** – A chemical compound that kills algae.

**Alkaline** – Having a pH greater than 7: the opposite of acidic.

**Allelopathy** – The production of growth inhibitors by one plant that retard the development of another plant.

**Allergic effects** – Harmful effects, such as skin rash or asthma, that some people develop in reaction to pesticides that do not cause the same reaction in most other people.

**Allergic effects statement** – a statement appearing on a pesticide label that states if tests or other data indicate that a pesticide product has the potential to cause allergic effects, such as skin irritation or asthma. Sometimes the labeling refers to allergic effects as “sensitization.”

**Alopecia** – Hair, feather or wool loss: may be due to any of a variety of causes.

**Amitraz** – A formamidine chemical with insecticidal and acaricidal properties.

**Anaphylactic shock** – An often severe and sometimes fatal systemic reaction in a susceptible animal upon exposure to a specific antigen (such as wasp or fly venom) after previous sensitization; characterized especially by respiratory symptoms, fainting, itching, and shock.

**Ancylostoma caninum** – Canine hookworm.

**Anemia** – Reduction or loss of red blood corpuscles.

**Anemic** – Weakened; lack of vitality due to blood loss or iron deficiency.

**Anaerobe** – An organism which does not require oxygen for its growth.

**Annual** – A plant that completes its life cycle in one year.

**Antagonism** – An interaction of two or more chemicals such that the effect, when combined, is less than the predicted effect based on the activity of each chemical applied separately.

**Anti-siphoning device** – An attachment designed to prevent backward flow into the water source.

**Antibiotic** – Chemical compounds produced by microorganisms which are toxic to other microorganisms.

**Antidote** – (1) A chemical applied to prevent the phytotoxic effect of a specific pesticide on desirable plants. (2) A substance used as a medical treatment to counteract poisoning.

**Antibiotics** – Chemical substances that destroy or inhibit the growth of bacteria and some other organisms. A veterinarian may prescribe antibiotics for a viral disease to prevent secondary bacterial infections, but antibiotics do not affect the viruses themselves.

**Anti-siphoning device** – An attachment to the filling hose designed to prevent backward flow into the water source.

**Aquatic plants** – Plants that grow on, in or under water.

**Aqueous** – Indicating the presence of water in a solution or environment.

**Arachnids** – Organisms from the class Arachnida, such as spiders, mites and ticks.

**Ascarids** – Any of the genus of parasitic roundworms.

**At emergence** – Treatment applied during the visible, emerging phase of the specified crop or weed.

**Atropine** – A mixture used to inhibit the actions of acetylcholine in the parasympathetic nervous system (as by relieving spasms of smooth muscle or dilating the pupil of the eye).

**Attractants** – Substances that lure insects to traps or to poison-bait stations; bait.

**Avicide** – A chemical used to control birds.

**Back-siphoning** – The movement of liquid pesticide mixture back through the filling hose and into the water source.

**Bacteria** – Extremely small, single-celled microorganisms that usually lack chlorophyll and reproduce by fission (splitting of the cell into two equal halves).

**Bactericide** – A pesticide used to control bacteria.

**Band application** – Placement of a pesticide in a narrow area either over or along the crop row.

**Band spraying** – Application of a pesticide to a strip over or along a crop row.

**Beneficial insects** – Insects that are useful to people — e.g. predators and parasites of pest species, bees and other pollinators.



**Benthic** – Of aquatic habitats; those organisms that live on or in the sediments; bottom-dwelling.

**Biennials** – Plants that require two growing seasons to complete their life cycle.

**Bioaccumulation** – The buildup of pesticides or other chemicals in the bodies of animals (including humans), particularly in fat tissue.

**Biocide** – A chemical able to kill microbial organisms.

**Biological control** – Control by predators and parasites, either naturally occurring or introduced.

**Biological degradation** – The breakdown of a pesticide due to the activities of living organisms, especially bacteria and fungi.

**Biology** – The science that deals with the structure, function, development, evolution, and ecology of living organisms.

**Biomass** – Volume of living plant material.

**Biotic** – Relating to living organisms.

**Biotype** – A population within a species that has distinct genetic variation.

**Bordetella** – Infectious bacterium that can cause tracheobronchitis.

**Botanical pesticide** – Organic pesticides derived or extracted directly from plants. Examples are nicotine, pyrethrin, strychnine and rotenone.

**Brand name** – The specific, registered name given by a manufacturer to a pesticide product; same as trade name or proprietary name.

**Broad-spectrum pesticide** – A pesticide that is effective against a wide range of pests or species.

**Broadcast application** – The uniform application of a pesticide to an entire field or area.

**Calibrate** – To measure and adjust the amount of pesticide the application equipment will release per unit of area.

**Calibration** – The process of measuring and adjusting the amount of pesticide that application equipment will apply to the target area.

**Carbamate** – A synthetic organic pesticide containing carbon, hydrogen, nitrogen and sulfur that are used as insecticide, fungicide and nematicides. They have similar effects on nerve function as organo-phosphates.

**Carcinogen** – A substance which has the ability to cause cancer.

**Carcinogenic** – Capable of causing cancer in animals or humans.

**Carrier** – A liquid or solid material added to a pesticide active ingredient or formulated product to facilitate its application. Also known as the material used to carry the pesticide to the target, e.g., water.

**Caution** – Signal word associated with pesticide products classified as either slightly toxic or relatively nontoxic.

**Cell** – The basic structural unit of all living organisms: An organism may be composed of a single cell (e.g. bacteria) or many cells working together (all “higher” organisms, including man).

**Certified applicator** – A person qualified to apply or supervise applications of restricted use pesticides.

**Certified commercial applicator** – Any person (other than private applicators) who is certified or registered to use or supervise the use of a restricted use pesticide and who is in the business of applying pesticides for others.

**Chelate** – A combination of a metal ion and an organic molecule. Combining the two makes the metal ion less reactive with other chemicals in water or in a soil solution.

**Chemical name** – Name applied to a pesticide active ingredient that describes its chemical structure according to rules prescribed by the American Chemical Society and published in the Chemical Abstracts Indexes.

**Chemical degradation** – The breakdown of a pesticide by oxidation, reduction, hydrolysis or other chemical means.

**Chemical-resistant** – Ability to prevent movement of pesticide through the material during the period of use.

**Chemigation** – The application of an agricultural chemical by injecting it into irrigation water.

**Cherry eye** – Swollen gland of the third eyelid of an animal that is visible as a large red mass on the inner corner of the eyelids.

**Chigger** – A six-legged mite larva that sucks the blood of vertebrates and causes intense irritation.

**Chlorinated hydrocarbons** – An insecticide/acaricide class that includes lindane, methoxychlor and naled.

**Chlorophyll** – The green photosynthetic substance in plants that allows them to capture solar energy and convert it to chemical energy.

**Chlorosis** – Loss of green color (chlorophyll) from foliage.

**Cholinesterase** – An enzyme that helps to control the transmission of nerve impulses in animals and humans.

**Chorioptic mange** – Veterinary term for infestation of *Chorioptes bovis*, a species of non-burrowing mange mites.

**Chronic effect** – Illness or injury that appears a long time, up to several years, after exposure to a pesticide.

**Chronic exposure** – Exposure to repeated doses of a pesticide over a period of time.

**Chronic toxicity** – A measure of the capacity of a pesticide to cause injury as a result of repeated exposures over a period of time.

**Closed mixing systems** – Systems in which liquid pesticide concentrates are transferred from their original containers to mix or spray tanks through a closed series of hoses, pipes, etc. Such systems are designed to prevent or minimize human exposure to the concentrates.

**Coccidia** – Parasitic protozoan that infests the digestive tract and can cause blood-tinged diarrhea in young puppies.

**Collection pad or tray** – A safety system designed to contain and recover spills, leaks, rinsates and other pesticide-containing materials.

**Colostrum** – Mammary secretion containing antibodies of the bitch. Puppies receive this fluid upon the first suckling and receive maternal antibodies and passive immunity to those diseases to which the bitch has immunity.

**Comatose** – Inactive, as in a coma.

**Commercial applicator** – Any persons other than private applicators, certified to apply pesticides.

**Common name** – (1) When referring to a pesticide, an abbreviated name applied to a herbicide active ingredient; usually agreed upon by the American National Standards Institute and the International Organization for Standardization. (2) When referring to an organism, a name derived from local common usage that is agreed upon by some accepted authority but may not be unique.

**Companion animals** – Pets such as dogs and cats.

**Compatibility** – Mixable in the formulation or in the spray tank for application in the same carrier without undesirable alterations in the characteristics or effects of the individual components.

**Compatibility agents** – Chemicals that enhance the effective mixing of two or more pesticide products.

**Congenital** – Condition existing at time of birth.

**Concentrate** – Pesticide having a high percentage of active ingredient; occasionally applied full-strength, but usually diluted before application.

**Concentration** – The amount of active ingredient or equivalent in a quantity of diluent expressed as percent, pounds per gallon (lb/gal), kilograms per liter (kg/l), etc.

**Contact herbicide** – A herbicide that causes localized injury to plant tissue where contact occurs.

**Contact pesticide** – A pesticide that kills pests simply by contacting them.

**Corrosion** – Process of being worn away gradually by chemical action.

**Cross contamination** – When one pesticide gets into or mixes with another pesticide accidentally; usually occurs in a pesticide container or in a poorly cleaned sprayer.

**Cultural control** – Control by changing management practices to reduce pest numbers without using pesticides.

**Cuticle** – Thin, fatty or waxy outer surface on the leaves of some plants.

**CZMA** – Coastal Zone Management Act.

**Danger** – Signal word associated with pesticide products that may cause skin irritation, or eye injury more severe than suggested by the acute toxicity (LD50) of the product.

**Days to harvest** – The minimum number of days allowed by law between the final application of a particular pesticide and the harvest date.

**Decontamination** – To rid of a polluting or harmful substance.

**Deflocculating agent** – A material added to a suspension to prevent settling.

**Degradation** – The breakdown of a pesticide into a simpler compound that is usually, but not always, non-toxic; may be either chemical, physical or biological or any combination of the three.

**Delayed effects** – Illnesses or injuries that do not appear immediately (within 24 hours) after exposure to a pesticide or combination of pesticides.

**Demodectic mange** – A variety of skin conditions caused by an infestation of follicle mites.

**Dermatitis** – The direct damage and inflammatory reaction of an animal's skin to arthropod bites or body secretions.

**Dermal toxicity** – Ability of a chemical to cause injury when absorbed through the skin.

**Dermal** – Of the skin; through or by the skin.

**Detection** – The first step in an IPM program; requires thorough and regular monitoring of animals for pest infestations or other signs and symptoms that indicate a pest is present on the animal or in the animal's environment.

**Dew claws** – Claws high on the inner side of dogs' legs that serve no useful function for most breeds. Consult veterinarian regarding removal.

**Diluent** – Anything used to dilute a pesticide; often referred to as the carrier.

**Dilute** – To make less concentrated.

**Dilute pesticide** – A pesticide that is not concentrated; one that does not have a high percentage of active ingredient.

**Directed application** – Precise application to a specific area or plant organ, such as to a row or bed or to the lower leaves and stems of plants.

**Direct supervision** – When a certified applicator is supervising the application of a pesticide and is physically present at the time and the place the pesticide is being applied.

**Directed spraying** – Aiming a pesticide at a specific portion of a plant or target site.

**Disinfection** – Disinfection is the act of maintaining animals and birds in an environment that is cleaned and sanitized daily, including kennels, doors, grids, eating bowls, water bottles, walls, ceiling, floors, food utensils, isolation areas, puppy rooms, runs, exercise areas and examination areas. Maintenance personnel should wear clean clothes daily and wash hands and arms after handling any animals with a disease problem.

**Dispersible granule** – A dry, granular formulation that will separate or disperse to form a suspension when added to water.

**Dispersing agent** – A material that reduces the attraction between particles.

**Distemper** – Common worldwide disease of dogs caused by canine distemper virus.

**Distributor products** – Products that are produced and registered by a manufacturer or formulator and sold under a different name by a distributor.

**Dock** – Shorten tail by cutting.

**Dormant** – State in which growth stops temporarily. May refer to plants, plant parts, microorganisms and certain animals.

**Dose** – (1) Amount, quantity or portion of a pesticide which is applied to a target. (2) A measure of exposure used in animal testing to determine acute and chronic toxicities; usually expressed in milligrams per kilogram body weight.

**DOT** – U.S. Department of Transportation.

**Drift** – Pesticide movement in air, away from the target site.

**Dust** – A finely-ground, dry pesticide formulation in which the active ingredient is combined with an inert carrier such as talc, clay, powdered nut hulls or volcanic ash; dusts are applied in the dry form.

**Ear mites** – Parasite that inhabits the ear canal and feeds by piercing the skin. Mites are visible to the naked eye. Ear mite infestation can be suspected if the ear passage contains a dark brown exudate with a characteristic odor.

**Early postemergence** – Applied after emergence during the cotyledonous growth phase of crop or weed seedlings.

**Eastern equine encephalitis** – Disease of horses, pheasants and humans caused by a virus transmitted by swamp mosquitoes among wild birds.

**Ecology** – The science that studies the interrelationships of living organisms and their environment.

**Economic damage** – The amount of injury that will justify the cost of applied control measures.

**Economic injury level** – The population density at which a pest causes a reduction in the value of the crop that is greater than the cost of control.

**Economic threshold or action threshold** – The population density at which management measures should be instituted to prevent an increasing pest population from reaching the economic injury level.

**Ecosystem** – A system formed by the interaction of a community of organisms with their environment.

**Ecto** – Prefix meaning “outside of the body.”

**Ectoparasite** – Organism that lives on the outside of the host body, more or less in permanent association.

**Emergence** – The event in seedling or perennial growth when a shoot becomes visible by pushing through the soil or water surface.

**Emerged plant** – A rooted or anchored aquatic plant adapted to grow with most of its leaf and stem tissue above the water surface and not lowering or rising with the water level.

**Emulsifiable concentrate (EC or E)** – A pesticide formulation that usually contains a liquid active ingredient, one or more petroleum-based solvents, and an agent that allows the formulation to be mixed with water to form an emulsion (droplets of one liquid dispersed in another liquid).

**Emulsifier** – Chemical that allows petroleum-based pesticides (EC's) to mix with water.

**Emulsion** – A mixture of two or more liquids that are not soluble in one another. One is suspended as small droplets in the other.

**Encapsulated pesticide** – A pesticide formulation in which the active ingredient is encased in extremely small capsules made of inert synthetic polymers. The pesticide is released gradually over a period of time.

**Endangered species** – A plant or animal that is in danger of becoming extinct.

**Endo** – Prefix meaning “inside the body.”

**Endoparasite** – Organism that invades internal body parts of the host.

**Entomology** – The science that deals with the study of insects.

**Environment** – All of our physical, chemical, and biological surroundings such as climate, soil, water and air and all species of plants, animals and microorganisms.

**Enzymes** – Proteins that increase the rate of specific chemical reactions.

**EPA** – U.S. Environmental Protection Agency.

**EPA establishment number** – A number assigned to each pesticide production plant by EPA which must appear on all labels.

**EPA Registration number** – A number assigned to a pesticide product by EPA when the product is registered by the manufacturer which must appear on all labels for that product.

**Epidemic** – A temporary widespread outbreak of a disease.

**Eradication** – Destroying an entire pest population in an area.

**Erosion** – Movement of soil and associated materials, principally by water and wind.

**Euthanize** – Kill in a humane manner.

**Exotic** – Native to other regions, countries or continents.

**Exposure** – Coming into contact with a pesticide; getting a pesticide on a surface or in or on an organism.

**Eyewash dispenser** – Commercially available system for flushing contaminants out of the eyes.

**FAA** – Federal Aviation Administration.

**Facultative myiasis** – Infestation by flies that are attracted to and lay eggs in wounds or injuries on animals.

**FDA** – Food and Drug Administration.

**FEPCA** – The Federal Environmental Pesticide Control Act of 1972. This law, including its many amendments replaces and adds to FIFRA. FIFRA remains as the commonly used acronym.

**FIFRA** – Federal Insecticide, Fungicide, and Rodenticide Act, as amended.

**Flowable (F or L)** – A pesticide formulation in which the active ingredient is impregnated on a diluent such as clay that is then finely ground and suspended in a small amount of liquid; the resulting paste or cream-like formulation is added to water in the spray tank and forms a suspension.

**Foaming agent** – A material designed to reduce drift, which causes a pesticide mixture to form a thick foam.

**Foliage** – Primarily the leaves; may include stems of a plant.

**Foliar** – Applied to the leaves of a plant.

**Foliar application** – Application of a pesticide to the aerial portions of either a crop or weed.

**Food chain** – A group of plants, animals and/or microorganisms linked together as sources and consumers of food.

**Formulation** – Pesticide product as sold, usually a mixture of active and inert ingredients; can be dry, solid, liquid or gas.

**Fowl pox** – Viral disease of domestic fowl and wild birds.

**Fragmentation** – Plant pieces that break off the parent plant and can develop new roots and become re-established.

**Fry** – Recently hatched fish.

**Fumigant** – Pesticide that is a vapor or gas or that forms a vapor or gas when applied and whose pesticidal action occurs in the gaseous state.

**Fungi** – A group of lower parasitic plants lacking chlorophyll.

**Fungicide** – A chemical used to control fungi.

**General use pesticide** – A pesticide that is not classified as a restricted use pesticide.

**Germination** – The process of initiating growth in seeds.

**GPA** – Gallons per acre.

**GPM** – Gallons per minute =  $\frac{\text{GPA} \times \text{MPH} \times \text{W}}{5940}$

**Granules (G)**: A dry pesticide formulation made by applying a liquid formulation of the active ingredient to particles of clay or another porous material. Granules are applied in the dry form and have a particle size substantially larger than dusts.

**GRAS** – Generally Recognized As Safe. Commonly used for risk assessment and to describe tested inert ingredients.

**Groundwater** – Water beneath the earth's surface in soil or rock.

**Growth regulator** – A substance used for controlling or modifying plant growth processes without appreciable phytotoxic effect at the dosage applied.

**Habitat** – The places where a plant or animal lives, feeds and breeds.

**Half life** – The length of time required for the quantity of a chemical to be reduced by half under a specific set of conditions.

**Hazard** – The likelihood that an injury will occur as a result of a given level and duration of exposure.

**Health certificate** – Document signed by a veterinarian that states an animal is free of clinical evidence of disease. Considered in most states to be an official document.

**Heartworm** – Thread-like worms (*Dirofilaria immitis*) that reside mostly in the right ventricle of the heart; transmitted by mosquitoes. Prevention possible.

**Heat stress** – Illness that occurs when the body is subjected to more heat than it can tolerate.

**Herbaceous plant** – A vascular plant that does not develop persistent woody tissue above ground.

**Herbicide** – A chemical used to control, suppress or kill plants or to severely interrupt their normal growth process.

**Hereditary defect** – Abnormal condition of the sire or dam, or of past generations of the sire or dam, that may be passed on to the current generation of animals.

**Hookworms** – An endoparasite (e.g. *Ancylostoma caninum*) that attaches to the intestinal wall and ingests blood. Infestation can lead to severe anemia and death.

**Hormone mimics** – A class of insecticides that prevents development of immature insects to the adult stage. These chemicals simulate the activity of juvenile hormone, the hormone in insects that maintains immature characteristics. (See insect growth regulator.)

**Host** – A plant or animal on or in which a pest lives or feeds.

**Hydraulic** – Operated by the pressure created by forcing liquid through a narrow opening.

**Hydraulic agitation** – Stirring or mixing provided by the high-pressure flow of surplus spray material from the pump.

**Hydrolysis** – Decomposition of a chemical compound by reaction with water.

**Hypersensitivity** – An extreme allergic reaction to insect bites, stings or secretions.

**Hypostome** – Feeding apparatus of a mite.

**Immunized** – Creation of antibody levels high enough to prevent a disease.

**Impermeable** – Cannot be penetrated.

**Incompatibility** – When two or more pesticides cannot be effectively mixed without a loss in activity, an increase in toxicity or hazard to the applicator or harm to the crop or the environment.

**Incubation** – Period of time between exposure to disease and development of clinical evidence of the disease.

**Inert ingredients** – Inactive components of a pesticide formulation that are used to dilute the pesticide or to make it safer, more effective, easier to measure, mix and apply and more convenient to handle.

**Ingestion** – Eating or swallowing.

**Ingredient name** – The active ingredients and the amount of each ingredient (as a percentage of the total product) in a pesticide listed by the official chemical name and/or common name for each active ingredient.

**Inhalation toxicity** – A measure of the capacity of a pesticide to cause injury when absorbed through the lungs.

**Inoculation** – Injection of a vaccine or bacterium.

**Inorganic** – Of mineral origin; does not contain carbon.

**Inorganic pesticides** – Pesticides of mineral origin; they do not contain carbon.

**Insect growth regulators** – A class of insecticides that prevent development of immature insects to the adult stage.

**Insecticide** – A chemical used to control insects.

**Insoluble** – Does not dissolve in liquid.

**Integrated pest management (IPM)** – An ecological approach to pest management in which all available techniques are consolidated into a unified program so that pest populations can be managed to avoid economic damage and minimize adverse effects.

**IPM** – Integrated pest management.

**Invert emulsion** – An emulsion in which water is dispersed in oil rather than oil in water; invert emulsions are normally quite thick and thus less susceptible to drift.

**Intermediate host** – A host that is usually used by a parasite in the course of its life cycle and in which it may multiply.

**Intranasal** – Administration of antigen via nasal passages.

**Invertebrates** – A class of animals that lack spinal cords.

**Ivermectins** – Group of insecticides labeled as drugs, that often come into use for pest control on animals.

**Isolate** – Set apart to prevent disease transmission.

**Isolation area** – An area or caging constructed to prevent spread of contagious conditions. The area or cage should have a ventilation system that prevents commingling of air from the isolation area with air in the healthy animal area.

**Juvenile hormones** – Natural insect chemicals that keep the earlier stages of an insect from changing into normal adult form.

**Label** – The information printed on or attached to the pesticide container or wrapper.

**Labeling** – The pesticide product label and other accompanying materials that contain directions that pesticide users are legally required to follow.

**Larvicide** – A pesticide used to kill insect larvae.

**Late postemergence** – Applied after the specified crop or weeds are well established.

**LC50** – The concentration of an active ingredient in air which is expected to cause death in 50 percent of the test animals so treated. A means of expressing the toxicity of a compound present in air as dust, mist, gas or vapor. It is generally expressed as micrograms per liter as a dust or mist but in the case of a gas vapor as parts per million (ppm).

**LD50** – The dose (quantity) of chemical(s) calculated to be lethal to 50 percent of the organisms in a specific test situation. It is expressed in weight of the chemical (mg) per unit of body weight (kg) of the test organism. The toxicant may be fed (oral LD50) or applied to the skin (dermal LD50).

**Leaching** – The movement of pesticide in water or another liquid downward through soil or other medium.

**Lesions** – Damage to an organ or tissue.

**Lethal** – Causing or capable of causing death.

**Lethargy** – Lack of energy, drowsy, dull, sluggish or inactive.

**Liability** – Legal responsibility.

**Life cycles** – The series of stages an organism passes through during its lifetime.

**Lime sulfur** – Inorganic chemical (calcium polysulfide) used for lice control.

**Local Effects** – Effects which occur at the site where the pesticide makes initial, direct contact with body (i.e. skin, eye, nose, mouth, trachea, esophagus, stomach, GI tract, etc.). Local effects may occur immediately or may take longer to appear. These may include such effects as: local (contact site) skin irritation (rash, irritation, ulceration) or local irritation of mucous membranes of eyes, nose, mouth, throat, etc.

**Macrophyte** – A large or macroscopic plant that is easily seen without the aid of a microscope.

**Mange** – Deterioration of the skin's condition, leading to hair or feather loss, skin discoloration, often disfiguring and, in severe cases, lethargy and weakness.

**Material Safety Data Sheets (MSDS)** – These data sheets contain specific information on toxicity, first aid, personal protection equipment, storage and handling precautions, spill and leak cleanup and disposal practices, transportation, physical data, and reactivity data. MSDS are available from manufacturers.

**Mechanical control** – Pest control by physically altering the environment.

**Mechanical agitation** – Stirring or mixing done by rotating paddles or propellers in the sprayer tank.

**Metabolite** – A compound derived from metabolic transformation of a chemical by plants or other organisms.

**Metamorphosis** – The series of changes in shape, form or size through which insects and insect-like organisms pass in their growth from immature stages to adult stage.

**MDA** – Michigan Department of Agriculture.

**MDEQ** – Michigan Department of Environmental Quality

**MDNR** – Michigan Department of Natural Resources.

**Microbial pesticide** – Bacteria, viruses and fungi used to cause disease in some pests.

**Microbicide** – A chemical able to kill microorganisms. Includes bactericides, algacides, and fungicides.

**Microfilaria** – Immature stages of canine heartworm that circulate in the blood.

**Microorganism** – An organism that is so small that it cannot be seen without the aid of a microscope.

**Mild steel** – Steel that contains a very low percentage of carbon; also called “soft steel.”

**Mineral oil** – Barrier against biting flies; also a diluent in some ear mite treatments that contain carbaryl.

**MIOSHA** – Michigan Occupational Safety and Health Administration.

**Miscible liquids** – Two or more liquids that can be mixed and will remain mixed under normal conditions.

**Miticide** – A chemical used to control mites.

**Mitigate** – To lessen, decrease or make less severe.

**Mode of action** – The way in which a pesticide exerts a toxic effect.

**Mold** – The vegetative phase in the growth of certain fungi displaying long filamentous extensions.

**Molluscicide** – A chemical used to control snails, slugs and other mollusks.

**Mollusks** – Group of animals with soft, unsegmented bodies that are usually, but not always, enclosed in shells.

**Monitoring** – The process of information gathering and collection through observation of a site or target organism.

**Mph** – Miles per hour.

$$\text{Speed (Mph)} = \frac{\text{distance (feet)} \times 60}{\text{time (seconds)} \times 88}$$

**MSHA** – Mine Safety and Health Administration

**Mucopurulent** – White or yellowish discharge containing mucus and pus, typically seen from the eyes or nose in animals with bacterial infections.

**Mutagenic** – Capable of producing genetic change.

**Mutation** – A change, usually harmful, in inherited genetic material.

**Mycoplasmas** – The smallest known living organisms that can reproduce and exist apart from other living organisms. They obtain their food from plants.

**Narrow-spectrum pesticide** – A pesticide that is effective against only one or a few species; the term is usually applied to insecticides and fungicides.

**Natural enemies** – The predators and parasites that attack pest species.

**Necrosis** – Localized death of tissue usually characterized by browning and desiccation.

**Necrotic** – Showing varying degrees of dead areas or spots.

**Nematicide** – A chemical used to control nematodes.

**Nematodes** – Small, slender, colorless roundworms that live saprophytically in soil or water or as parasites of plants, animals or fungi; plant-parasitic nematodes are so small that they cannot be seen except through a microscope.

**Neoprene** – A synthetic rubber characterized by superior resistance to penetration by pesticides.

**Neurotoxic** – A pesticide which is harmful to nerve tissue.

**NIOSH** – National Institute for Occupational Safety and Health.

**Nits** – The eggs of lice.

**No observable effect level (NOEL)** – The dose of substance which causes no observable effects.

**NOAA** – National Oceanic and Atmospheric Administration.

**Non-persistent pesticide** – A pesticide that breaks down quickly after it is applied.

**Non-selective herbicide** – A herbicide that is generally toxic to all species of plants. This toxicity may be a function of dosage, method of application, timing of application or other such factor. Some selective herbicides may become non-selective if used at very high rates.

**Non-selective pesticide** – A pesticide that is toxic to most plants, insects or animals.

**Non-target** – Any site or organism other than the site or pest toward which the control measures are being directed.

**Non-target organisms** – All plants, animals and microorganisms other than the intended target(s) of a pesticide application.

**Noxious weed** – A weed specified by law as being especially undesirable, troublesome and difficult to control. Definition will vary according to legal interpretations.

**Nymphs** – Larvae that emerge from insect eggs of many insects and arthropods.

**Obligatory myiasis** – Infestation of bot flies in animals occurring when the larval stages are living inside the skin or tissues of the animal.

**Ocular** – Pertaining to the eye.

**Offsite** – Outside the area where the pesticide is being released.

**Oil solution** – A liquid pesticide formulation in which the active ingredient is dissolved either in oil or some other organic solvent.

**Oncogen** – A substance having the ability to cause tumors; the tumor may or may not be cancerous.

**Oncogenic** – Capable of producing or inducing tumors in animals, either benign (non-cancerous) or malignant (cancerous).

**Oncogenicity** – The ability to cause tumors.

**Oral toxicity** – A measure of the capacity of a pesticide to cause injury when taken by mouth.

**Oral** – Of the mouth; through or by the mouth.

**Organic** – Containing carbon.

**Organic matter** – Materials and debris that originated as living plants or animals.

**Organic pesticides** – Pesticides that contain carbon. Most are synthetic; some are derived or extracted from plants.

**Organophosphate** – A synthetic organic pesticide containing carbon, hydrogen and phosphorus; parathion and malathion are two examples used primarily as insecticides and act on nervous system.

**OSHA** – Occupational Safety and Health Administration in the United States Department of Labor.

**Ovicide** – A chemical that destroys eggs.

**Parainfluenza** – Pneumonia-like infection caused by canine parainfluenza virus.

**Parasite** – An organism living on, in or with another living organism for the purpose of obtaining food.

**Parts per million, weight (PPMW)** – One part of a substance in one million parts of another substance, by weight; for example, approximately 2.72 lb of active ingredient applied to 1 acre-foot of water will give 1 PPMW.

**Parvovirus** – Virus that attacks growing tissues (especially the intestinal tract) in puppies that are not immunized.

**Passive immunity** – Immunity not of the young animal's own making, for example from maternal antibodies that offer only temporary protection.

**Patella** – Kneecap.

**Pathogen** – An organism that causes disease in other organisms.

**Pelleted formulation** – A dry formulation of herbicide and other components in discrete particles, usually larger than 10 cubic millimeters, and designed to be applied without a liquid carrier.

**Penetrant** – Chemical that helps a pesticide get through a surface and into an object or organism.

**Percolation** – Downward seepage of water through the soil.

**Perennials** – Plants that live for more than two years.

**Persistence** – A measure of how long a pesticide remains in an active form at the site of application or in the environment.

**Persistent pesticide** – A pesticide that remains active for a period of time after application and gives continued protection against a pest.

**Personal protective equipment (PPE)** – Devices and clothing worn to protect the human body from contact with pesticides or pesticide residues.

**Pest** – An unwanted organism (plant, animal, bacteria, etc.); any organism that competes with people for food, feed or fiber, impacts aesthetic qualities, or impedes industrial or recreational activities.

**Pesticide** – A substance or mixtures of substances intended to prevent, destroy, repel or control undesirable organisms.



**Pesticide concentrate** – A pesticide formulation as it is sold before dilution.

**Pesticide handler** – Person who directly handles pesticides, such as during mixing, loading, transporting, storing, disposing and applying or working on pesticide equipment.

**Pesticide handling** – Directly working with pesticides, such as during mixing, loading, transporting, storing, disposing, and applying or working on pesticide equipment.

**Pesticide interaction** – The action or influence of one pesticide upon another and the combined effect of the pesticide on the pest(s) or crop system.

**Pesticide registration** – The status given to a product to allow for its sale and use as a pesticide by the Environmental Protection Agency or by the state to meet a special local need.

**Petiole** – Stalk of a leaf.

**Petroleum-based** – Made from petroleum products. Examples are: xylene, refined oil and kerosene.

**pH** – A measure of the acidity or alkalinity of a solution.

**Pheromones** – Chemicals emitted by an organism to influence the behavior of other organisms of the same species.

**Phloem** – The living tissue in plants that functions primarily to transport metabolic compounds from the site of synthesis or storage to the site of utilization.

**Photic zone** – Portion of a body of water in which enough light can penetrate to support aquatic plant growth.

**Photodecomposition** – Degradation of a pesticide by light.

**Photosynthesis** – The process in green plants of synthesizing carbohydrates from carbon dioxide and water, utilizing light energy captured by chlorophyll.

**Physiology** – The branch of biology that deals with the functions and activities of living organisms.

**Phytotoxicity** – Injury to plants due to chemical exposure.

**Piscicide** – A chemical used to kill or control fish.

**Plant disease** – Any harmful condition that makes a plant different from a normal plant in its appearance or function.

**Plant growth regulator** – A substance used for controlling or modifying plant growth processes.

**Plant pathology** – The science that deals with the nature and causes of plant disease.

**Poison** – A chemical that is very highly toxic acutely. Legally, a chemical with an oral LD50 of 50 mg/kg or less.

**Porous surfaces** – Surfaces that have tiny openings which allow liquid to be absorbed or to pass through.

**Postemergence** – Applied after emergence of the target weed or crop.

**Pour-ons** – High-concentrate, low-volume pesticide formulations applied directly to animals from the containers they are purchased in.

**PPB** – Parts per billion. One ppb equals 1 pound in 500,000 tons.

**PPM** – Parts per million. One ppm equals 1 pound in 500 tons.

**PPT** – Parts per trillion. One ppt equals 1 pound in 500,000,000 tons.

**Pre-emergence** – Applied to the soil prior to emergence of the target weed or crop. Control of weeds before or soon after they emerge.

**Precautionary statements** – Pesticide labeling statements that alert you to possible hazards from use of the pesticide product and that sometimes indicate specific actions to take to avoid the hazards.

**Precipitate** – A solid substance that no longer will remain dissolved in water because of some physical or chemical process.

**Predator** – An organism that attacks, kills and feeds on other organisms.

**Premise spray** – An insecticide that will persist on the surfaces in an animal's living area for a period of time.

**Prevention** – Keeping a pest from becoming a problem.

**Private applicators** – Persons using or supervising the use of restricted use pesticides to produce an agricultural commodity on their own or their employer's land, or on lands rented by them.

**Propagation** – Reproduction by either sexual or asexual means.

**Propriety name** – Same as brand name.

**Protectant** – A chemical applied to a plant or animal in anticipation of a pest problem to prevent infection or injury.

**Protectant pesticide** – Pesticide applied to a target site to prevent pest establishment.

**Protectant fungicide** – Pesticide applied to prevent the development of some plant diseases caused by fungi.

**psi** – Pounds per square inch.

**Psittacines** – Birds related to parrots.

**Psoroptic mange** – Veterinary term for infestation of *Psoroptes ovis*, species of non-burrowing mange mites.

**Pustules** – Eruptions containing pus, such as boils or pimples.

**Rabies** – Virus that affects the central nervous system.

**Rate** – The amount of active ingredient or acid equivalent applied per unit area or other treatment unit.

**RCRA** – The Resource Conservation and Recovery Act — the federal law regulating the transport, storage, treatment and disposal of hazardous wastes.

**Ready-to-use pesticide** – A pesticide that is applied directly from its original container consistent with label directions, such as an aerosol insecticide or rodent bait box, which does not require mixing or loading prior to application.

**Reciprocity** – An agreement between states to allow certified applicators in one state to obtain certification credentials in the other state.

**Registered pesticide** – A pesticide approved by the Environmental Protection Agency for use as stated on the label or by the state to meet a special local need.

**Registered technician** – A classification of applicators in Michigan who are authorized to apply general use pesticides for a commercial or private purpose as a scheduled and required work assignment.

**Registration** – The regulatory process designated by FIFRA and conducted by the EPA through which a pesticide is legally approved for use.

**Release** – When a pesticide leaves its container or the equipment or system that is containing it and enters the environment. Release can be intentional, as in an application, or by accident, as in a spill or leak.

**Reregistration** – Requirement by recent legislation that older pesticides be reevaluated against current standards. A Special Review Process is used to evaluate specific questions or concerns about a

pesticide and decide whether the registration should be adjusted in any way.

**Residual pesticide** – A pesticide that continues to be effective for an extended period of time after application.

**Residue** – The part of a pesticide that remains in the environment for a period of time following application or a spill.

**Residue tolerance** – The maximum amount of a pesticide that may legally remain in or on a raw farm product intended for consumption by people or livestock.

**Resistance (pesticide)** – The genetically acquired ability of an organism to tolerate the toxic effects of a pesticide.

**Respiration** – (1) The process by which living cells utilize oxygen to transform the energy in food molecules into biologically useful forms. (2) The act of breathing.

**Restricted entry interval** – The length of time that must elapse after a pesticide application before people who are not using personal protective equipment can enter the treated site.

**Restricted-use pesticide** – Pesticides designated by the EPA for restricted use because without additional regulatory restrictions, unreasonable adverse effects on the environment, including injury to the applicator, could occur. A “restricted-use” pesticide may be used only by or under the direct supervision of a certified applicator.

**Resurgence** – A dramatic increase in the population level of a target pest some time after a pesticide application due to the destruction of its natural enemies by the pesticide; pest numbers may soon surpass pretreatment levels.

**Ringworm** – Ring-shaped patch on skin caused by a fungus.

**Risk** – A combination of toxicity and exposure and is the possibility of loss or injury from exposure.

**Risk/Benefit** – A scientific approach in which the risk posed by a certain substance is weighed against the benefit of its use.

**Rhizomes** – Lateral roots.

**Rinsate** – Wash water that contains a small amount of pesticide.

**Roundworm** – Internal parasitic worm (ascarid).

**Runoff** – Pesticide movement across a surface away from the application site in water or another liquid.

**Sanitizer** – Chemical compounds that reduce microbial contamination.

**Sarcoptic mange mite** – Parasite that burrows under the skin, causing intense itching; can be transmitted to people.

**Saprophyte** – An organism that obtains its food from dead or decaying organic matter.

**SARA** – Superfund Amendments and Reauthorization Act — amendments to the Comprehensive Environmental Response, Compensation, and Liability Act (CERCLA).

**Scabies** – Any skin condition of man or animal associated with a mite; a particularly serious, debilitating, mange condition.

**Scientific name** – The Latin name for the genus and species of an organism, designated by taxonomists and universally accepted. Scientific names are often used to avoid confusion which can result from the use of common names which may vary from one area to another.

**Scouting** – Regular monitoring of a crop or site in a prescribed manner to determine the pest population levels and the extent of pest damage.

**Sebaceous glands** – Oil glands.

**Secondary infection** – Infection that occurs following the primary infection, as a result of lowered immunity; e.g., infection following the scratching of flea bites.

**Selective pesticide** – A pesticide that is more toxic to some kinds of plants and animals than to others.

**Selectivity** – the ability of a chemical to be more toxic to some species than to others; may be a function of dosage or mode of application.

**Self-limiting** – Refers to a disease or condition that will clear up by itself after a period of time.

**Semipermeable** – Some substances can pass through and others cannot.

**Senesce** – To decline or fade; to age.

**Sensitive areas** – Sites or organisms that are particularly vulnerable to harmful effects from pesticides.

**Shampoo** – Formulation of insecticide and other ingredients that is applied to an animal's wet fur and worked into a lather.

**Signal words and symbols**– Standardized designations of relative levels of toxicity which must, by law, appear on pesticide labels. The signal words used are DANGER, or DANGER-POISON with skull and crossbones, or WARNING, or CAUTION.

**Site** – The crop, animal or area infested by a pest and to which a pesticide is applied.

**Slurry** – A thick suspension of a finely-divided pesticide in a liquid.

**Soft and hard water** – A water quality parameter where soft waters exhibit total hardness less than 50 mg calcium carbonate per liter (parts per million); hard waters have total hardness greater than 100 mg calcium carbonate per liter; moderately hard waters are those between 50 and 100 mg calcium carbonate per liter.

**Solubility** – The ability to dissolve; such as the capacity of a pesticide to dissolve in a specific solvent.

**Soluble** – Able to be dissolved in another substance, usually a liquid.

**Soluble powder (SP)** – Dry pesticide formulation that forms a true solution when mixed with water.

**Solution** – A homogeneous mixture of one or more substances (solutes) in another substance (solvent), which is usually a liquid. The solutes are completely dissolved and will not settle out or separate under normal conditions.

**Solvent** – A liquid, such as water, kerosene, xylene or alcohol, that will dissolve a pesticide (or other substance) to form a solution.

**Space spray** – Method of application of an insecticide that kills the insects that are in the area at the time of application.

**Special local need (SLN)** – An existing or imminent pest problem within the state which cannot be adequately controlled by the use of any available federally registered pesticide product. The EPA can approve temporary use of a pesticide to alleviate the need.

**Species** – The basic unit of taxonomic classification, designating a group of closely related individuals that are capable of interbreeding.

**Spot-ons** – High-concentrate, low volume pesticide formulation applied directly to the animal from the container the product is sold in.

**Spot treatment** – Application of pesticides applied to restricted area(s) of a whole unit; e.g., treatment of spots or patches of weeds within a larger field or water body.

**Spray drift** – Movement of airborne spray from the intended area of application.

**Spreader** – A chemical that increases the area that a given volume of liquid will cover on a solid or on another liquid.

**Staphylococcus** – Type of bacterium frequently associated with skin infections.

**State Management Plan** – A written plan that establishes guidelines for activities that will protect groundwater from pesticide contamination. Required by the EPA so that states may register pesticides that pose a threat to groundwater quality.

**Statement of practical treatment (first aid)** – Instructions on how to respond to an emergency exposure involving a pesticide product.

**Sterilant** – A pesticide that renders a pest incapable of reproduction.

**Sterility** – The inability of a living organism to reproduce.

**Sticker** – An adjuvant that increases the ability of a pesticide to stick to treated plant surfaces.

**Stomach poison** – A pesticide that kills when it is eaten and swallowed by a pest.

**Stomata** – Minute openings on the surfaces of leaves and stems through which gases (oxygen, carbon dioxide, water vapor) and some dissolved materials pass into and out of plants.

**Subclinical** – Not readily apparent disease.

**Sublethal** – Pertaining to a dose level that is less than an amount necessary to cause death.

**Substrate** – The surface on which an organism lives.

**Supervise** – The act or process of a certified applicator in directing the application of a pesticide by competent person under his or her instruction and control and for whose actions the certified applicator is responsible, even though the certified applicator is not physically present at the time and the place the pesticide applied.

**Suppression** – Reducing pest numbers or damage to an acceptable level.

**Surface water** – Water on top of the earth's surface, such as lakes, streams, rivers, irrigation ditches, or storm water drains.

**Surfactant** – A material that improves the emulsifying, dispersing, spreading, wetting or other surface modifying properties of liquids.

**Susceptibility** – The sensitivity to or degree to which an organism is injured by a pesticide treatment. (See tolerance.)

**Susceptible** – Capable of being diseased or poisoned; not immune.

**Suspended registration** – An emergency suspension of a pesticide registration stops all manufacture, distribution, sale and use of the pesticide until all court proceedings are concluded.

**Suspension** – A substance that consists of undissolved particles mixed throughout a liquid.

**Swath width** – Side-to-side measurement of the band or strip of pesticide released by the application equipment.

**Symptom** – (1) Any detectable change in an organism resulting from the activities of a pathogen or other pest. (2) An indication of pesticide poisoning.

**Synergism** – The combined activity of two or more pesticides that is greater than the sum of their activity when used alone.

**Synergist** – Something that enhances the effectiveness of the active ingredient(s) in a formulation.

**Synthetic** – Man-made; manufactured.

**Synthetic pyrethroids** – A class of insecticides/ acaricides—including permethrin, resmethrin and allethrin—that shows properties of low mammalian toxicity but good activity against insects, ticks and mites.

**Systemic effects** – Effects which occur at sites other than the point of entry into the body following absorption and distribution through the circulatory system, possible chemical reaction within the body or contact with critical target sites, or organs.

**Systemic pesticide** – A pesticide that is taken into the blood of an animal or sap of a plant.

**Tank mix** – A mixture in the spray tank of two or more pesticide products for simultaneous application.

**Tank-mix combination** – Mixing two or more pesticides or agricultural chemicals in the spray tank at the time of application.

**Tapeworm** – Intestinal parasitic worm (Cestode).

**Target** – The site or pest toward which control measures are being directed.

**Target pest** – The pest toward which management measures are being directed.

**Taxonomy** – The classification of living organisms into groups based on similarities and relationships.

**Teratogen** – Any substance which can cause the development of malformations such as in birth defects.

**Terrestrial** – Living or growing on land; not aquatic.

**Thickeners** – Drift control agents such as cellulose, gels, and swellable polymers which cause the formation of a greater proportion of large spray droplets.

**Tip-and-pour** – Built-in measuring device that fills with a given amount of pesticide when the container is tilted.

**Tolerance** – (1) Capacity to withstand pesticide treatment without marked deviation from normal growth or function. (See susceptibility.) (2) The concentration of pesticide residue that will be legally allowed in or on agricultural products.

**Topical** – External, upon the skin.

**Toxemia** – An abnormal condition associated with the presence of toxic substances in the blood.

**Toxicity** – Measure of a pesticide's ability to cause acute, delayed, or allergic effects.

**Toxicology** – The study of the principles or mechanism of toxicity.

**Toxin** – A poisonous substance produced by a living organism.

**Tracheobronchitis** – Upper respiratory infection. Common name is “kennel cough.”

**Trade name** – A trademark applied to a pesticide formulation by its manufacturer.

**Translocated herbicide** – A pesticide that kills plants by being absorbed by leaves, stems or roots and moved throughout the plant. Translocated herbicides may be either phloem mobile or xylem mobile, but the term is frequently used in a more restrictive sense to refer to herbicides that are applied to the foliage and move downward through the phloem to underground plant parts.

**Translocation** – The internal movement of food, water, minerals or other materials (e.g. pesticides) from one part of a plant to another.

***Trichuris vulpis*** – Endoparasite (whipworm) of dogs that attaches to the intestinal wall and ingests blood.

**Ulceration** – Open sore.

**Use site** – The immediate environment where a pesticide is being mixed, loaded, applied, transported, stored, or disposed of, or where pesticide-contaminated equipment is being cleaned.

**USDA** – United States Department of Agriculture.

**Vaccine** – Antigens introduced into the body that stimulates the formation of protective immunity.

**Vapor drift** – The movement of chemical vapors from the area of application. Note: Vapor injury and injury from spray drift are often difficult to distinguish.

**Vapor pressure** – The property which causes a chemical to evaporate. The lower the vapor pressure, the more easily it will evaporate.

**Vascular plant** – A plant (macrophyte) with specialized conductive tissue.

**Vascular system** – The conducting tissue of plants, composed principally of xylem and phloem.

**Vector** – Means through which a disease causing organism is transmitted from one place to another.

**Vegetative reproduction** – Production of new plants from vegetative plant parts such as root-stocks, rhizomes, stolons, tubers, cuttings, etc., rather than from seed.

**Vertebrate** – An animal with a jointed backbone.

**Virulent** – Highly infectious; capable of causing disease.

**Virus** – An obligate parasite often consisting only of a piece of genetic material surrounded by a protein coat.

**Volatile** – Evaporating rapidly; turning easily into a gas or vapor.

**Volatility** – The degree to which a liquid or solid changes into a gas (vapor) at ordinary temperatures when exposed to air.

**Warning** – Signal word associated with pesticide products considered moderately toxic.

**Water-based pesticides** – Pesticides that use water as the only diluent or carrier.

**Water-dispersible granules** – A pesticide formulation in which finely-divided powders are formulated into concentrated, dustless granules which form a suspension in water.

**Water-soluble concentrate (WS)** – A liquid pesticide formulation in which the active ingredient is soluble in water and is formulated either with water or another solvent such as alcohol which mixes readily with water.

**Watershed** – The area of land draining into a body of water.

**Weed** – A plant growing where it is not desired; any plant that is objectionable or interferes with the activities or welfare of humans.

**Wettable powder (WP or W):** A finely-divided, relatively insoluble pesticide formulation in which the active ingredient is combined with an inert carrier such as clay or talc and with a wetting or dispersing agent; a wettable powder forms a suspension rather than a true solution in water.

**Wetting agent** – (1) Substance that serves to reduce interfacial tensions and causes spray solutions or suspensions to make better contact with treated surfaces (See surfactant). (2) A substance in a wettable powder formulation that causes it to wet readily when added to water.

**Whipworm** – Internal parasite (*Trichuris vulpis*) that infests lower intestinal tract .

**Wipes** – Pesticide formulation applied directly to the animal; cloths or sponges saturated with the product.

**Woods lamp** – Ultraviolet light with an eye-protecting filter; helpful in identifying some kinds of ringworm.

**WPS** – Worker Protection Standard for agricultural pesticides.

**Xylem** – The tissue in higher plants which transports water, dissolved salts, and other materials (e.g. pesticides) from the roots to aerial portions of the plant.

# APPENDIX A

## Convenient Conversion Factors

Multiply	By	To Get
Acres	0.405	Hectares
Acres	4,047.0	Square Meters
Acres	4,840.0	Square Yards
Acres-feet	43,560.0	Square feet
Acre-feet	1,233.49	Cubic Meters
Acre-feet	43,560.0	Cubic Feet
Acre-feet	325,850.58	Gallons
Bushels	0.0461	Cubic yards
Bushels	1.2437	Cubic feet
Bushels	4.0	Pecks
Bushels	32.0	Quarts (dry)
Bushels	35.24	Liters
Bushels	64.0	Pints (dry)
Bushels	2,150.42	Cubic inches
Centimeters	0.3627	Inches
Centimeters	0.01	Meters
Centimeters	10.0	Millimeters
Cubic centimeters	0.0610	Cubic inches
Cubic centimeters	0.03381	Ounces (liquid)
Cubic centimeters	1.0	Milliliters of water
Cubic centimeters	1.0	Grams of water
Cubic feet	0.0283	Cubic meters
Cubic feet	0.0370	Cubic yards
Cubic feet	0.8040	Bushels
Cubic feet	7.4805	Gallons
Cubic feet	25.71	Quarts (dry)
Cubic feet	28.32	Liters
Cubic feet	29.92	Quarts (liquid)
Cubic feet	51.42	Pints (dry)
Cubic feet	59.84	Pints (liquid)
Cubic feet	62.4	Pounds of water
Cubic feet	1,728.0	Cubic inches
Cubic feet	28,317.0	Cubic centimeters
Cubic meters	1.308	Cubic yards
Cubic meters	35.31	Cubic feet
Cubic meters	264.2	Gallons
Cubic meters	1,000.0	Liters
Cubic meters	1,057.0	Quarts (liquid)
Cubic meters	2,113.0	Pints (liquid)
Cubic meters	61,023.0	Cubic inches
Cubic meters	1,000,000.0	Cubic centimeters
Cubic inches	0.000016	Cubic meters
Cubic inches	0.0005	Bushels
Cubic inches	0.0006	Cubic feet
Cubic inches	0.0019	Pecks (dry)

Multiply	By	To Get
Cubic inches	0.0037	Gallons (dry)
Cubic inches	0.0043	Gallons (liquid)
Cubic inches	0.0149	Quarts (dry)
Cubic inches	0.0164	Liters
Cubic inches	0.0173	Quarts (liquid)
Cubic inches	0.0298	Pints (dry)
Cubic inches	0.0346	Pints (liquid)
Cubic inches	0.0361	Pounds of water
Cubic inches	0.5540	Ounces (liquid)
Cubic inches	16.3872	Cubic centimeters
Cubic yards	0.7646	Cubic meters
Cubic yards	21.71	Bushels
Cubic yards	27.0	Cubic feet
Cubic yards	202.0	Gallons (liquid)
Cubic yards	807.9	Quarts (liquid)
Cubic yards	1,616.0	Pints (liquid)
Cubic yards	7,646.0	Liters
Cubic yards	46,656.0	Cubic inches
Cups	0.25	Quarts (liquid)
Cups	0.5	Pints (liquid)
Cups	8.0	Ounces (liquid)
Cups	16.0	Tablespoons
Cups	48.0	Teaspoons
Cups	236.5	Milliliters
Feet	0.3048	Meters
Feet	0.3333	Yards
Feet	12.0	Inches
Feet	30.48	Centimeters
Feet per minute	0.01136	Miles per hour
Feet per minute	0.01667	Feet per second
Feet per minute	0.01829	Kilometers per hour
Feet per minute	0.3048	Meters per minute
Feet per minute	0.3333	Yards per minute
Feet per minute	60.0	Feet per hour
Gallons	0.00378	Cubic meters
Gallons	0.1337	Cubic feet
Gallons	3.785	Liters
Gallons	4.0	Quarts (liquid)
Gallons	8.0	Pints (liquid)
Gallons	8.337	Pounds
Gallons	128.0	Ounces (liquid)
Gallons	231.0	Cubic inches (liquid)
Gallons	269.0	Cubic inches (dry)
Gallons	3,785.0	Cubic centimeters

<b>Multiply</b>	<b>By</b>	<b>To Get</b>
Gallons of water	0.0038	Cubic meters
Gallons of water	0.0049	Cubic yards
Gallons of water	0.1337	Cubic feet
Gallons of water	3.7853	Kilograms
Gallons of water	8.3453	Pounds of water
Gallons of water	3,785.3446	Grams
Grains	0.0648	Grams
Grams	0.001	Kilograms
Grams	0.0022	Pounds
Grams	0.0353	Ounces
Grams	15.53	Grains
Grams	1,000.0	Milligrams
Grams per liter	10.0	Percent
Grams per liter	1,000.0	Parts per million
Hectares	2.47	Acres
Hectares	10,000.0	Square meters
Hectares	11,954.8	Square yards
Hectares	107,593.2	Square feet
Inches	0.0254	Meters
Inches	0.02778	Yards
Inches	0.08333	Feet
Inches	2.54	Centimeters
Kilograms	0.0011	Tons
Kilograms	2.205	Pounds
Kilograms	35.28	Ounces
Kilograms	1,000.0	Grams
Kilometers	0.6214	Miles
Kilometers	1,000.0	Meters
Kilometers	1,093.611	Yards
Kilometers	3,280.833	Feet
Kilometers per hour	0.6214	Miles per hour
Kilometers per hour	16.6667	Meters per minute
Kilometers per hour	18.2268	Yards per minute
Kilometers per hour	54.6806	Feet per minute
Liters	0.001	Cubic meters
Liters	0.0353	Cubic feet
Liters	0.2642	Gallons (liquid)
Liters	1.0	Kilograms of water
Liters	1.057	Quarts (liquid)
Liters	2.113	Pints (liquid)
Liters	33.8143	Ounces
Liters	61.02	Cubic inches
Liters	1,000.0	Cubic centimeters
Liters	1,000.0	Grams of water

<b>Multiply</b>	<b>By</b>	<b>To Get</b>
Meters	0.001	Kilometers
Meters	1.094	Yards
Meters	3.281	Feet
Meters	39.37	Inches
Meters	100.0	Centimeters
Meters	1,000.0	Millimeters
Metric tons	1.1	Tons (U.S.)
Metric tons	1,000.0	Kilograms
Metric tons	2,204.6	Pounds
Metric tons	1,000,000.0	Grams
Miles	1.6093	Kilometers
Miles	1,609.3	Meters
Miles	1,760.0	Yards
Miles	5,280.0	Feet
Miles per hour	1.467	Feet per second
Miles per hour	1.6093	Kilometers/ hour
Miles per hour	26.8217	Meters per minute
Miles per hour	29.3333	Yards per minute
Miles per hour	88.0	Feet per minute
Miles per minute	26.82	Meters per second
Miles per minute	29.333	Yards per second
Miles per minute	88.0	Feet per second
Milliliters	0.00105	Quarts (liquid)
Milliliters	0.0021	Pints (liquid)
Milliliters	0.0042	Cups (liquid)
Milliliters	0.0338	Ounces (liquid)
Milliliters	0.0676	Tablespoons
Milliliters	0.2029	Teaspoons
Milliliters	1.0	Cubic centimeters of water
Milliliters	1.0	Grams of water
Ounces (liquid)	0.00781	Gallons
Ounces (liquid)	0.03125	Quarts (liquid)
Ounces (liquid)	0.0625	Pints (liquid)
Ounces (dry)	0.0625	Pounds
Ounces (liquid)	0.125	Cups (liquid)
Ounces (liquid)	1.805	Cubic inches
Ounces (liquid)	2.0	Tablespoons
Ounces (liquid)	6.0	Teaspoons
Ounces (dry)	28.3495	Grams
Ounces (liquid)	29.573	Milliliters
Ounces (dry)	437.5	Grains
Parts / million (PPM)	0.0001	Percent
Parts per million	0.001	Liters/cubic meter
Parts per million	0.001	Grams per liter



Multiply	By	To Get
Parts per million	0.001	Milliliters per liter
Parts per million	0.013	Ounces per 100 gallons of water
Parts per million	0.0584	Grains per US gallon
Parts per million	0.3295	Gallons per acre-foot of water
Parts per million	1.0	Milligrams/ liter
Parts per million	1.0	Milligrams per kilogram
Parts per million	1.0	Milliliters per cubic meter
Parts per million	2.7181	Pounds per acre-foot of water
Parts per million	8.345	Pounds per million gallons of water
Pecks	0.25	Bushels
Pecks	8.0	Quarts (dry)
Pecks	16.0	Pints (dry)
Pecks	537.605	Cubic inches
Percent (%)	1.33	Ounces (dry) per gallon of water
Percent	8.34	Pounds per 100 gallons of water
Percent	10.00	Grams per kilogram
Percent	10.00	Grams per liter
Percent	10,000.00	Parts per million
Pints (dry)	0.0156	Bushels
Pints (dry)	0.0625	Pecks
Pints (liquid)	0.125	Gallons
Pints (liquid)	0.4735	Liters
Pints (liquid)	0.5	Quarts (liquid)
Pints (dry)	0.5	Quarts (dry)
Pints (liquid)	2.0	Cups
Pints (liquid)	16.0	Ounces (liquid)
Pints (liquid)	28.875	Cubic inches (liquid)
Pints (dry)	33.6003	Cubic inches (dry)
Pounds	0.0005	Tons
Pounds	0.4535	Kilograms
Pounds	16.0	Ounces
Pounds	453.5924	Grams
Pounds	7,000.0	Grains
Pounds of water	0.0160	Cubic feet
Pounds of water	0.1198	Gallons
Pounds of water	0.4536	Liters
Pounds of water	27.693	Cubic inches
Quarts (liquid)	0.00094	Cubic meters
Quarts (liquid)	0.0012	Cubic yards

Multiply	By	To Get
Quarts (dry)	0.03125	Bushels
Quarts (liquid)	0.0334	Cubic feet (liquid)
Quarts (dry)	0.0389	Cubic feet (dry)
Quarts (dry)	0.125	Pecks
Quarts (liquid)	0.25	Gallons (liquid)
Quarts (liquid)	0.9463	Liters
Quarts (liquid)	2.0	Pints (liquid)
Quarts (dry)	2.0	Pints (dry)
Quarts (liquid)	2.0868	Pounds of water
Quarts (liquid)	4.0	Cups
Quarts (liquid)	32.0	Ounces (liquid)
Quarts (liquid)	57.75	Cubic inches (liquid)
Quarts (dry)	67.20	Cubic inches (dry)
Square feet	0.000009	Hectares
Square feet	0.000023	Acres
Square feet	0.0929	Square meters
Square feet	0.1111	Square yards
Square feet	144.0	Square inches
Square inches	0.00064	Square meters
Square inches	0.00077	Square yards
Square inches	0.00694	Square feet
Sq. kilometers	0.3861	Square miles
Sq. kilometers	100.0	Hectares
Sq. kilometers	247.104	Acres
Sq. kilometers	1,000,000.0	Square meters
Sq. kilometers	1,195,982.7	Square yards
Sq. kilometers	10,763,865.0	Square feet
Square meters	0.0001	Hectares
Square meters	1.308	Square yards
Square meters	10.765	Square yards
Square meters	1,549.9669	Square feet
Square miles	2.5899	Square kilometers
Square miles	258.99	Hectares
Square miles	640.0	Acres
Square miles	2,589,735.5	Square meters
Square miles	3,097,600.0	Square yards
Square miles	27,878,400.0	Square feet
Square yards	0.00008	Hectares
Square yards	0.00021	Acres
Square yards	0.8361	Square meters
Square yards	9.0	Square feet
Square yards	1,296.0	Square inches
Tablespoons	0.0625	Cups
Tablespoons	0.5	Ounces
Tablespoons	3.0	Teaspoons
Tablespoons	15.0	Milliliters

<b>Multiply</b>	<b>By</b>	<b>To Get</b>
Teaspoons	0.0208	Cups
Teaspoons	0.1667	Ounces
Teaspoons	0.3333	Tablespoons
Teaspoons	5.0	Milliliters
Tons	0.907	Metric ton
Tons	907.1849	Kilograms

<b>Multiply</b>	<b>By</b>	<b>To Get</b>
Tons	2,000.0	Pounds
Tons	32,000.0	Ounces
Yards	0.000568	Miles
Yards	0.9144	Meters
Yards	3.0	Feet
Yards	36.0	Inches

# APPENDIX B

## Michigan State University Extension Directory

### COUNTY EXTENSION OFFICES

#### Alcona County Extension

PO Box 800  
Harrisville, MI 48740-0800  
Phone: 517-724-6478  
Fax: 517-724-5684

#### Alger County Extension

101 Court Street  
Munising, MI 49862-1196  
Phone: 906-387-2530  
Fax: 906-387-2710

#### Allegan County Extension

County Building Annex  
108 Chestnut Street  
Allegan, MI 49010-1314  
Phone: 616-673-0370  
Fax: 616-673-7005

#### Alpena County Extension

603 South 11th Avenue  
Alpena, MI 49707-2645  
Phone: 517-354-3636  
Fax: 517-354-5411

#### Antrim County Extension

County Building  
PO Box 427  
Bellaire, MI 49615-0427  
Phone: 616-533-8818  
Fax: 616-533-8392

#### Arenac County Extension

County Building  
PO Box 745  
Standish, MI 48658-0745  
Phone: 517-846-4111

#### Baraga County Extension

Courthouse Annex  
12 North 3rd Street  
L'Anse, MI 49946-1085  
Phone: 906-524-6300  
Fax: 906-524-61301

#### Barry County Extension

220 West Court Street  
Hastings, MI 49058-  
Phone: 616-948-4862  
Fax: 616-948-4884

#### Bay County Extension

1220 Washington Avenue  
Bay City, MI 48708-5893  
Phone: 517-895-4026  
Fax: 517-895-4217

#### Benzie County Extension

Governmental Center  
PO Box 307  
Beulah, MI 49617-0307  
Phone: 616-882-0025  
Fax: 616-882-9605

#### Berrien County Extension

5060 St. Joseph Avenue  
Stevensville, MI 49127-1046  
Phone: 616-429-2425  
Fax: 616-429-1309

#### Branch County Extension

Courthouse  
Coldwater, MI 49036-1990  
Phone: 517-279-8511-256  
Fax: 517-278-4130

#### Calhoun County Extension

County Building  
315 West Green Street  
Marshall, MI 49068-1585  
Phone: 616-781-0784  
Fax: 616-781-0647

#### Cass County Extension

201 East State Street  
Cassopolis, MI 49031-1352  
Phone: 616-445-8661  
Fax: 616-445-3690

#### Charlevoix County Extension

319B North Lake Street  
Boyer City, MI 49712-1101  
Phone: 616-582-6232  
Fax: 616-582-2831

#### Cheboygan County Extension

County Building  
PO Box 70  
Cheboygan, MI 49721-0070  
Phone: 616-627-8815  
Fax: 616-627-8881

#### Chippewa County Extension

300 Court Street  
Sault Ste. Marie, MI 49783-  
Phone: 906-635-6368

#### Clare County Extension

County Building  
PO Box 439  
Harrison, MI 48625-0439  
Phone: 517-539-7805  
Fax: 517-539-2791

#### Clinton County Extension

County Services Building  
306 Elm  
St. Johns, MI 48879-2398  
Phone: 517-224-5240  
Fax: 517-224-5244

#### Crawford County Extension

County Building  
200 Michigan Avenue  
Grayling, MI 49738-1743  
Phone: 517-348-2841  
Fax: 517-348-7582

#### Delta County Extension

2840 College Avenue  
Escanaba, MI 49829-9595  
Phone: 906-786-3032  
Fax: 906-786-2643

#### Dickinson County Extension

Community Services Center  
800 Crystal Lake Boulevard  
Iron Mountain, MI 49801-2765  
Phone: 906-774-0363  
Fax: 906-774-4672

#### Eaton County Extension

Suite One  
551 Courthouse Drive  
Charlotte, MI 48813-1047  
Phone: 517-543-2310  
Fax: 517-543-8119

#### Emmet County Extension

County Building  
200 Division Street  
Petoskey, MI 49770-2493  
Phone: 616-348-1770  
Fax: 616-348-0633

#### Genesee County Extension

County Building #2  
G-4215 West Pasadena Avenue  
Flint, MI 48504-2376  
Phone: 810-732-1470  
Fax: 810-732-1400

#### Gladwin County Extension

County Library Building  
555 West Cedar Street  
Gladwin, MI 48624-2095  
Phone: 517-426-7741  
Fax: 517-426-4281

#### Gogebic County Extension

104 South Lowell  
Ironwood, MI 49938-2092  
Phone: 906-932-1420  
Fax: 906-932-9762

#### Grand Traverse Co Extension

1102 Cass Street, Suite A  
Traverse City, MI 49684-2092  
Phone: 616-922-4620  
Fax: 616-922-4633

#### Gratiot County Extension

204 South Main  
Ithaca, MI 48847-1465  
Phone: 517-875-5322  
Fax: 517-875-2990

#### Hillsdale County Extension

20 Care Drive  
Hillsdale, MI 49242-  
Phone: 517-439-9301  
Fax: 517-439-4290

#### Houghton/Keweenaw County Extension

1500 Birch Street  
Hancock, MI 49930-1095  
Phone: 906-482-9301  
Fax: 906-482-4978

#### Huron County Extension

Room 104, County Building  
250 East Huron Avenue  
Bad Axe, MI 48413-1397  
Phone: 517-269-9949  
Fax: 517-269-7221

#### Ingham County Extension

121 East Maple Street  
PO Box 319  
Mason, MI 48854-1655  
Phone: 517-676-7207  
Fax: 517-676-7230

221 East Maple Street  
PO Box 319  
Mason, MI 48854-1655  
Phone: 517-484-9461

#### Ionia County Extension

100 Library Street  
Ionia, MI 48846-1691  
Phone: 616-527-5357  
Fax: 616-527-5380

#### Iosco County Extension

PO Box 599  
Tawas City, MI 48764-0599  
Phone: 517-362-3449  
Fax: 517-362-3871

#### Iron County Extension

2 South 6th Street  
Crystal Falls, MI 49920-1413  
Phone: 906-875-6642

#### Isabella County Extension

County Annex Building  
201 North Main Street  
Mt. Pleasant, MI 48858-2321  
Phone: 517-772-0991-302  
Fax: 517-773-7431

#### Jackson County Extension

1699 Lansing Ave.  
Jackson, MI 49202-2296  
Phone: 517-788-4292  
Fax: 517-788-4640

#### Kalamazoo County Extension

Room 302  
201 West Kalamazoo Avenue  
Kalamazoo, MI 49007-3777  
Phone: 616-383-8832  
Fax: 616-384-8035

#### Kalkaska County Extension

County Government Center  
605 North Birch  
Kalkaska, MI 49646-9436  
Phone: 616-258-3320  
Fax: 616-258-4678

#### Kent County Extension

836 Fuller Avenue, NE  
Grand Rapids, MI 49503-1992  
Phone: 616-336-3265  
Fax: 616-336-3836

#### Keweenaw

(See Houghton-Keweenaw)

#### Lake County Extension

Route 3  
Box 2235  
Baldwin, MI 49304-2235  
Phone: 616-745-2732  
Fax: 616-745-6213

#### Lapeer County Extension

1575 Suncrest Drive  
Lapeer, MI 48446-1195  
Phone: 810-667-0341  
Fax: 810-667-0355

#### Leelanau County Extension

116 East Philip Street  
Lake Leelanau, MI 49653-9701  
Phone: 616-256-9888  
Fax: 616-256-9431

#### Lenawee County Extension

Suite 2020  
1040 South Winter Street  
Adrian, MI 49221-3867  
Phone: 517-264-5300  
Fax: 517-264-5317

*Continued on next page*

**Livingston County Extension**

820 East Grand River Avenue  
Howell, MI 48843-2497  
Phone: 517-546-3950  
Fax: 517-546-5154

**Luce County Extension**

County Building, Room 26  
407 West Harrie Street  
Newberry, MI 49868-1208  
Phone: 906-293-3203  
Fax: 906-923-3581

**Mackinac County Extension**

Courthouse  
100 Marley Street  
St. Ignace, MI 49781-1495  
Phone: 906-643-7307  
Fax: 906-643-7302

**Macomb County Extension**

Verkuilen Building  
21885 Dunham Road  
Clinton Township, MI 48036-1030  
Phone: 313-469-5180  
Fax: 313-469-6948

**Manistee County Extension**

6433 - Eight Mile Road  
Bear Lake, MI 49614-9712  
Phone: 616-889-4277  
Fax: 616-889-5930

**Marquette County Extension**

200 West Spring Street  
Marquette, MI 49855-  
Phone: 906-228-1556  
Fax: 906-228-1549

**Mason County Extension**

Suite 4  
102 South Main Street  
Scottville, MI 49454-1221  
Phone: 616-757-4789  
Fax: 616-757-2977

**Mecosta County Extension**

14485 Northland Dr.  
Big Rapids, MI 49307  
Phone: 616-592-0792  
Fax: 616-592-9492

**Menominee County Extension**

PO Box 157  
Stephenson, MI 49887-0157  
Phone: 906-753-2209  
Fax: 906-753-2200

**Midland County Extension**

220 West Ellsworth Street  
Midland, MI 48640-5194  
Phone: 517-832-6640  
Fax: 517-832-6758

**Missaukee County Extension**

6180 West Sanborn Road  
PO Box 800  
Lake City, MI 49651-0904  
Phone: 616-839-4667  
Fax: 616-839-5282

**Monroe County Extension**

963 South Raisinville Road  
Monroe, MI 48161-9740  
Phone: 313-243-7113  
Fax: 313-243-7000

**Montcalm County Extension**

617 North State Road  
PO Box 308  
Stanton, MI 48888-0308  
Phone: 517-831-5226  
Fax: 517-831-8863

**Montmorency County Extension**

Courthouse Annex  
PO Box 415  
Atlanta, MI 49709-0415  
Phone: 517-785-4177

**Muskegon County Extension**

635 Ottawa Street  
Muskegon, MI 49442-1016  
Phone: 616-724-6361  
Fax: 616-724-6675

**NW Mich. Hort. Res. Station**

6686 Center Highway  
Traverse City, MI 49684-  
Phone: 616-946-1510  
Fax: 616-946-1404

**Newaygo County Extension**

817 South Stewart Avenue  
Fremont, MI 49412-9201  
Phone: 616-924-0500  
Fax: 616-924-6480

**Oakland County Extension**

Dept 416  
1200 North Telegraph Road  
Pontiac, MI 48341-0416  
Phone: 810-858-0880  
Fax: 810-858-1477

**Oceana County Extension**

210 Johnson Street  
PO Box 151  
Hart, MI 49420-0151  
Phone: 616-873-2129  
Fax: 616-873-3710

**Ogemaw County Extension**

County Building  
806 West Houghton Avenue  
West Branch, MI 48661-1215  
Phone: 517-345-0692  
Fax: 517-345-4939

**Ontonagon County Extension**

Courthouse  
725 Greenland Road  
Ontonagon, MI 49953-1492  
Phone: 906-884-2767  
Fax: 906-884-2582

**Osceola County Extension**

Courthouse  
PO Box 208  
Reed City, MI 49677-1149  
Phone: 616-832-6139

**Oscoda County Extension**

Courthouse Annex  
Box 69  
Mio, MI 48647-0069  
Phone: 517-826-3241

**Otsego County Extension**

200 Livingston Boulevard  
Gaylord, MI 49735-9397  
Phone: 517-731-0272  
Fax: 517-731-0744

**Ottawa County Extension**

333 Clinton Street  
Grand Haven, MI 49417-1492  
Phone: 616-846-8250  
Fax: 616-846-0655

**Presque Isle County Extension**

151 East Huron Avenue  
PO Box 110  
Rogers City, MI 49779-1709  
Phone: 517-734-2168  
Fax: 517-734-4116

**Roscommon County Extension**

Courthouse  
PO Box 507  
Roscommon, MI 48653-0507  
Phone: 517-275-5043  
Fax: 517-275-5675

**SW Mich. Research & Ext Center**

1791 Hillandale Road  
Benton Harbor, MI 49022-  
Phone: 616-944-1477  
Fax: 616-944-3106

**Saginaw County Extension**

705 Adams Street  
Saginaw, MI 48602-2192  
Phone: 517-799-2233  
Fax: 517-799-2238

**Sanilac County Extension**

37 Austin Street  
Sandusky, MI 48471-1298  
Phone: 810-648-2515  
Fax: 810-648-3087

**Schoolcraft County Extension**

Room 218  
County Courthouse  
Manistique, MI 49854-1485  
Phone: 906-341-5050  
Fax: 906-341-5680

**Shiawassee County Extension**

701 South Norton  
Corunna, MI 48817-1298  
Phone: 517-743-2251  
Fax: 517-743-4891

**St. Clair County Extension**

108 McMorrان Boulevard  
Port Huron, MI 48606-4061  
Phone: 810-985-7169  
Fax: 810-985-5931

**St. Joseph County Extension**

Courthouse  
Box 280  
Centreville, MI 49032-0280  
Phone: 616-467-5522  
Fax: 616-467-5641

**Tuscola County Extension**

362 Green Street  
Caro, MI 48723-1998  
Phone: 517-672-3870  
Fax: 517-673-5953

**UP Michigan Hort Exper Station**

102 University Drive  
Chatham, MI 49816-0168  
Phone: 906-439-5114  
Fax: 906-439-5698

**VanBuren County Extension**

Suite A  
801 Hazen Street  
Paw Paw, MI 49079-1075  
Phone: 616-657-7745  
Fax: 616-657-6678

**WC Michigan Hort Res Station**

9302 Portland Road  
Clarksville, MI 48815-  
Phone: 616-693-2193  
Fax: 616-693-2317

**Washtenaw County Extension**

County Services Center  
4133 Washtenaw Ave., Box 8645  
Ann Arbor, MI 48107-8645  
Phone: 313-971-0079  
Fax: 313-971-1307

**Wayne County Extension**

6th Floor  
640 Temple Street  
Detroit, MI 48201-2558  
Phone: 313-494-3005  
Fax: 313-494-3031

**Wexford County Extension**

437 East Division Street  
Cadillac, MI 49601-1905  
Phone: 616-467-5511  
Fax: 616-779-0292

**UNIVERSITY OUTREACH REGIONAL OFFICES****MSUE - East Central Region**

2203 Eastman Avenue  
Midland, MI 48640-2608  
Phone: 517-839-8540  
Fax: 517-839-8504

**MSUE - North Region**

Suite 102  
2200 DendrinDr.  
Traverse City, MI 49684  
Phone: 616-929-3902  
Fax: 616-929-0454

**MSUE - Southeast Region**

28115 Meadowbrook  
Novi, MI 48377-3128  
Phone: 810-380-9100  
Fax: 810-380-9194

**MSUE - Southwest Region**

310 Administration Building  
201 West Kalamazoo Avenue  
Kalamazoo, MI 49007-3777  
Phone: 616-383-6465  
Fax: 616-383-6466

**MSUE - UP Region**

1030 Wright Street  
Marquette, MI 49855-1891  
Phone: 906-228-4830  
Fax: 906-228-4572

**MSUE - West Central Region**

110 Commerce Building  
5 Lyon Street  
Grand Rapids, MI 49503-3117  
Phone: 616-458-6805  
Fax: 616-458-6665

**MSU BULLETIN OFFICE**

10-B Agriculture Hall  
Michigan State University  
East Lansing, MI 48824-1039

Phones:  
Single Copies: 517-355-0240  
Bulk Copies: 517-353-6740  
Fax: 517-353-7168

## APPENDIX C

# MICHIGAN DEPARTMENT OF AGRICULTURE PESTICIDE & PLANT PEST MANAGEMENT DIVISION

P.O. BOX 30017  
LANSING, MICHIGAN 48909  
(517) 373-1087



### REGION 1

State Office Building  
Room 117  
Escanaba, MI 49829  
(906) 786-5462

### REGION 2

701 S. Elmwood Ave., Suite 9  
Traverse City, MI 49684-3185  
(616) 922-5210

### REGION 3

State Office Building  
350 Ottawa, N.W.  
Grand Rapids, MI 49503  
(616) 456-6988

### REGION 4

Saginaw State Office Building  
411-F East Genesee  
Saginaw, MI 48607  
(517) 758-1778

### REGION 5

4032 M-139, Building 116  
St. Joseph, MI 49085-9647  
(616) 428-2575

### REGION 6

611 W. Ottawa  
North Ottawa Building  
Lansing, MI 49833  
(517) 373-1087

### REGION 7

Lahser Center Building  
26400 Lahser Road  
Southfield, MI 48034  
(810) 356-1701

## APPENDIX C continued

### DEPARTMENT OF ENVIRONMENTAL QUALITY (formerly Department of Natural Resources) ENVIRONMENTAL RESPONSE DIVISION DIVISION AND DISTRICT OFFICES

When calling these offices, be sure to ask for the **Environmental Response Division Staff**

#### DIVISION OFFICE

Knapps Office Center  
300 S. Washington Square  
P.O. Box 30028  
Lansing, MI 48909  
Fax: (517) 373-2637  
Phone: (517) 373-9837

#### Fire Marshall Division

Hazardous Materials Section  
P.O. Box 30157  
Lansing, MI 48909  
Phone: (517) 322-1935

#### DISTRICT OFFICES

##### Cadillac District Office

Rt. #1  
8015 South Mackinaw Trail  
Cadillac, MI 49601  
Fax: (517) 775-9671  
Phone: (616) 775-9727

##### Grayling District Office

1955 N. I-75, BL, R#3  
Grayling, MI 49738  
(517) 348-6371

##### Grand Rapids District Office

350 Ottawa Street, NW  
Grand Rapids, MI 49503  
Fax: (616) 456-1239  
Phone: (616) 456-5071

##### Jackson District Office

301 Louis Glick Highway  
Jackson, MI 49201  
Fax: (517) 780-5055  
Phone: (517) 780-5000

##### Lansing District Office

P.O. Box 30028  
State Secondary Complex  
Lansing, MI 48909  
Fax: (517) 322-6311  
Phone: (517) 322-1300

##### Marquette District Office

1990 U.S. 41 South  
Marquette, MI 49855  
Fax: (906) 228-5245  
Phone: (906) 228-6561

##### Plainwell District Office

1342-B, M-89  
Plainwell, MI 49080  
Fax: (616) 692-3050  
Phone: (616) 692-2120

##### Roscommon District Office

P.O. Box 128  
8717 North Roscommon Road  
Roscommon, MI 48653  
Fax: (517) 275-5167  
Phone: (517) 275-5151

— District Boundaries

● District Office

##### Saginaw Bay District Office

503 N. Euclid Avenue  
Bay City, MI 48706  
Fax: (517) 684-4482  
Phone: (517) 684-9141

##### Southeast District Office

38980 Seven Mile Road  
Livonia, MI 48152  
Fax: (313) 953-0243  
Phone: (313) 953-0241

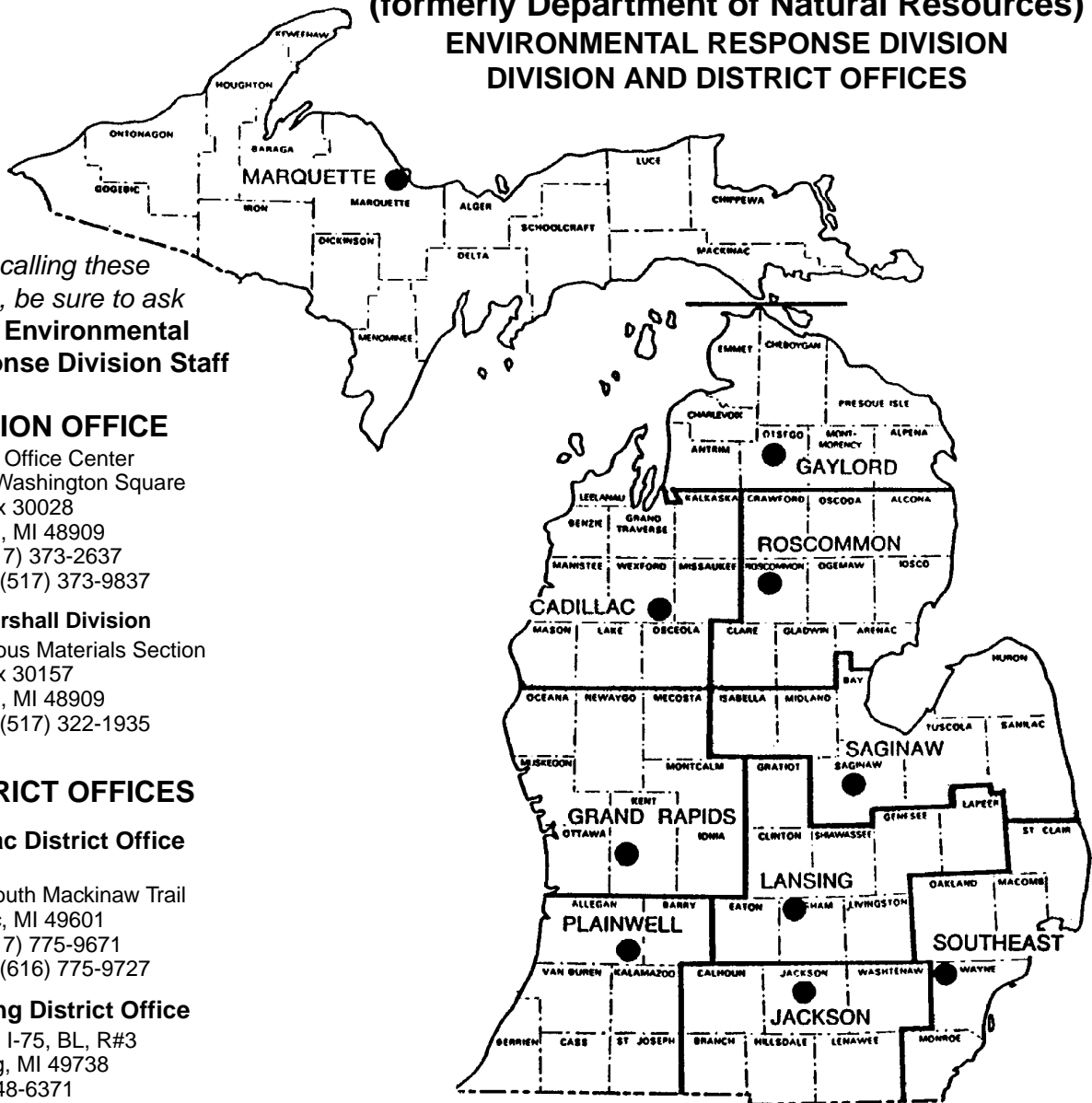

---

## APPENDIX C continued

### Michigan Groundwater and Fresh Water Protection Act Sources of information and assistance:

Michigan Department of Agriculture  
Region 6 - Groundwater Program  
611 W. Ottawa  
North Ottawa Building  
Lansing, MI 49833  
(517) 373-1087

Grand Traverse MSU Extension - Groundwater Program  
1102 Cass St. Suite A  
Traverse City, MI 49684  
(616) 922-4620

Kalamazoo MSU Extension Office - Groundwater Program  
Room 302  
201 W. Kalamazoo Ave.  
Kalamazoo, MI 49007-3777  
(616) 383-8830

Michigan Department of Agriculture  
Region 3 - District Extension Agent - Groundwater Program  
State Office Bldg. Room 2C  
350 Ottawa N.W.  
Grand Rapids, MI 49503-2321  
(616) 456-6988

Natural Resource Conservation Service  
Contact person located at MDA Region 6 office.  
See above. (517) 373-1087

Inquiries can be sent to internet address:  
[rouget@msue.msu.edu](mailto:rouget@msue.msu.edu)

### Michigan Counties with Endangered Species Interim Bulletins Available for the Kirtland's Warbler:

Alcona, Clare, Crawford, Iosco, Kalkaska, Missaukee, Montmorency, Ogemaw,  
Oscoda, Presque Isle and Roscommon.







# PESTICIDE EMERGENCY INFORMATION

For any type of an emergency involving a pesticide, immediately contact the following emergency information center for assistance.

Current as of January 1996



## Human Pesticide Poisoning

M I C H I G A N P O I S O N C O N T R O L S Y S T E M

From anywhere in Michigan, call

**1 - 8 0 0 - P O I S O N - 1**  
**1 - 8 0 0 - 7 6 4 - 7 6 6 - 1**

## Special Pesticide Emergencies

Animal Poisoning .....	Pesticide Fire .....	Traffic Accident .....	Environmental Pollution .....	Pesticide disposal information .....
Your veterinarian:	Local fire department:	Local police department or sheriff's department:	Pollution Emergency Alerting System (PEAS), Michigan Department of Environmental Quality:	Michigan Department of Environmental Quality Waste Management Division. <b>Monday - Friday: 8 a.m.-5 p.m.</b> (517) 373-2730

Phone No. \_\_\_\_\_  
or  
Animal Health Diagnostic Laboratory (Toxicology)  
Michigan State University:  
(517) 355-0281

Phone No. \_\_\_\_\_  
and  
Fire Marshal Division,  
Michigan State Police:  
**M-F: 8-12, 1-5**  
(517) 322-5847

Phone No. \_\_\_\_\_  
and  
For environmental emergencies:  
\* 1-800-292-4706  
also  
\* 1-800-405-0101  
Michigan Department of Agriculture Spill Response

\* Telephone Number Operated 24 Hours

**National Pesticide Telecommunications Network**  
Provides advice on recognizing and managing pesticide poisoning, toxicology, general pesticide information and emergency response assistance.  
Funded by EPA, based at Texas Tech University Health Services Center.  
**Monday - Friday:**  
**8:00 a.m. - 6:00 p.m. Central Time Zone**  
**1-800-858-7378**

(PLEASE POST IN AN APPROPRIATE PLACE)

Revised by Pesticide Education Program, Michigan State University Extension



▲ FOLD TOP FLAP IN, FOLD AGAIN AND SEAL WITH TAPE ▲

▼ CUT ALONG DOTTED LINE ▼

---

---

---

PLACE  
STAMP  
HERE

Michigan State University Extension  
Pesticide Education Program  
Agriculture Hall  
East Lansing, MI 48824-1039

## We would like to hear from you!

Your input is valuable for making the pesticide certification training manuals appropriate for your industry.

Please take a moment to fill out this evaluation form and return it to the Pesticide Education Program office, Michigan State University Extension.

1. Were the learning objectives at the beginning of each chapter useful to your study of this manual? Yes or No
2. Did you work through the review questions at the end of each chapter? Yes or No  
If yes, did you find them helpful for preparing to take the Michigan Department of Agriculture (re)certification exam? Yes or No
3. Is there information that you believe would enhance the usefulness of this training manual that was NOT included? Please explain.
4. Were the pest management methods described in this manual typical of those used by people in your industry? Yes or No.  
If no, please explain.
5. Do you feel the MDA certification exam reflects the information found in this manual?
6. Please share with us your comments on how we can improve this or other pesticide certification training manuals or the pesticide certification process.

Thank you for your time and input. Remove this sheet, fold in thirds, tape closed and mail back to the Michigan State University Extension Pesticide Education Program Office, or return to your local county Extension office for forwarding, or FAX it to us at (517) 353-4995.

Thanks again!

---

---

Your name, address and  
telephone number (optional):

---

---