

HOME STORAGE of FRUITS and VEGETABLES



Written and Illustrated by Susan MacKay,
Northeast Regional Agricultural Engineering Service

Acknowledgements

Arthur Pratt, Retired Professor, Vegetable Crops, Cornell University
Arthur Selders, Extension Agricultural Engineer, West Virginia University
Ruth Klippstein, Professor, Nutritional Sciences, Cornell University
Len Topoleski, Professor, Vegetable Crops, Cornell University
John Bartok, Jr, Extension Agricultural Engineer, University of Connecticut
J.A. McCurdy, Extension Agricultural Engineer, Pennsylvania State University
Hollis Davis, Professor Emeritus, Agricultural Engineering, Cornell University

NRAES-7

\$1.50

Obtain additional copies of this book from COOPERATIVE EXTENSION at any of the institutions listed on the inside back cover or order from NRAES, Riley Robb Hall, Cornell University, Ithaca, NY, 14853. Quantity discount available. Tel (607)256-7654

©1979, Northeast Regional Agricultural Engineering Service
All rights reserved. Inquiry invited. First Edition. July 1979
Second printing, Oct 1979. Third printing, Oct 1982.

Contents

I	Storage as a Food Preservation Method	1
	<i>Source of Produce/ Food Preservation Methods—Freezing, Canning, Drying, Storage/ The Best Conditions for Storage</i>	
II	Outdoor Storages	5
	<i>In-Garden Storages/ Surface Storages/ Trench Storages/ Buried Containers/ Outdoor Storage Cellars/ Outbuildings</i>	
III	Indoor Storages	11
	<i>Modern Basements - Windows with wells, Bulkhead/ Base- ment Storage Room - Construction, Operation/ Attics/ Pantry/ Unheated Rooms and Closets</i>	
IV	Harvesting and Handling Produce for Storage	17
	<i>Packing Materials/ Timing of Storage/ Use of Stored Produce</i>	
V	Specific Storage Conditions	19
	<i>Vegetables/ Fruits/ Other Stored Foods - Cheese, Canned Goods, Nuts</i>	
VI	Plans	27
	<i>Exterior Storage Cellars/ Interior Storage Room</i>	
VII	For Further Reading	30

I Storage as a Food Preservation Method

The increasing cost of food has resulted largely from higher energy and labor costs in producing, processing, and transporting food. More than half of the money spent on food is for marketing services.

Cutting food costs and concern for the wholesomeness of food have led many people to return to producing part or all of their own food supply. Coincident with this is the resurgence of interest in home food preservation. Home canning has become popular again, and the home freezer has been adopted by many as a convenient means of food preservation.

Researchers are looking for ways to use natural conditions to supplement or replace the use of fossil fuels for heating and refrigeration. Recent studies using cold weather as an add-on system for operating cold storages in food processing plants, dairy farms, and retail stores are meeting with some success. These studies may also show the feasibility of running home refrigerators during the winter with readily accessible cold winter air. Using the natural environment to assist in heating and cooling is not a new discovery, but rather a lost art.

Storage of fruits and vegetables was used extensively by our ancestors. It makes use of cold weather for refrigeration and includes any method of preserving food that does not require processing. It will be of interest to gardeners hoping to increase their self-sufficiency beyond the growing season, and to those wishing to purchase quantities of certain fresh produce, in season, for use throughout the winter. While storage does not involve investment in expensive equipment, it does require an awareness of food characteristics and some materials and maintenance to assist natural conditions.

Source of Produce

If you are growing your own produce you have the greatest potential for cost savings, but you also supply the labor and suffer losses in the field. There may be problems with weeds, insects, rodents, plant diseases and disorders, and weather conditions. There is also a considerable cash investment in gardening equipment and supplies.

But growing your own produce has many advantages. For many, the personal satisfaction of working with nature and achieving a degree of self-sufficiency make the commitment of time and energy worthwhile. Produce harvested at peak maturity from the garden generally has better flavor and

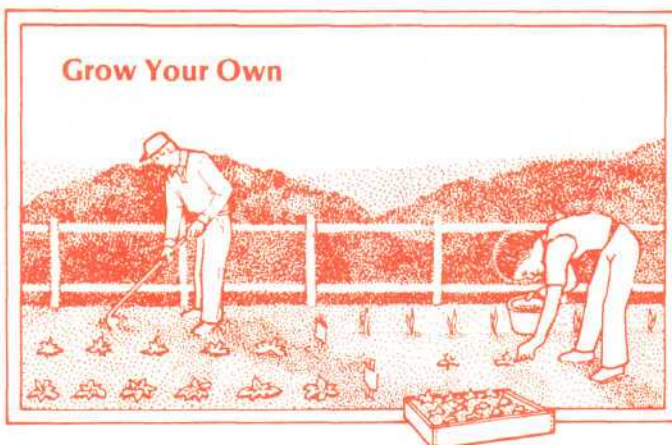

higher nutritional value than produce available in the supermarket. Home-grown produce can be harvested in the correct manner for storage, and stored *immediately* at harvest, which is essential for the most complete retention of nutrients. You also have the option of harvesting from the garden throughout the winter and/or early spring. The variety in your vegetable diet can be increased by planting vegetables adaptable to storage, but not readily available in the marketplace.

But you may not have the land, time, or inclination to grow your own produce. If you buy at harvest time from farmer's markets, consumer cooperatives, or wholesale produce markets, you can buy at advantageous prices, choosing which produce you wish to store, how much, and at what time. The greatest selection and best quality is usually available just after the market opens. There are also cost savings in "pick-your-own" operations, since you are providing the harvest labor.



If you are buying produce in bulk for storage, you should be aware of which varieties of produce are suitable for storage. This information can be obtained from seed catalogs or from a knowledgeable retailer or farmer. Many people participating in farmer's markets welcome bulk orders to your specifications (e.g. celery with roots attached).

The cost savings of home food preservation are not as good when you buy food in bulk compared to growing it. But buying and preserving by storage or canning is still generally cheaper than buying in the store all year long. Freezing only has potential cash savings if the produce is home grown, or can be purchased at very attractive prices.

Food Preservation Methods

There are four basic ways to preserve foods - storage, drying, canning, and freezing. Each fruit and vegetable varies in its adaptability to different preservation methods (Table 1 and 2).

Table 1. Preservation Methods for Specific Vegetables

Produce	Store	Can	Pickle/ Preserve	Freeze
Asparagus				X
Beans, Wax or Green		X		X*
Beans, Dry (kidney, navy, white marrows, turtles)	X			
Beets	X*	X	X	
Broccoli		X		X*
Brussels Sprouts	X			X
Cabbage	X*		X	
Cauliflower	X			X
Celery	X			
Chard				X
Chinese Cabbage	X			
Corn		X	X	X
Greens - Kale Swiss Chard Spinach	X	X		X X
Horseradish	X		X	
Kohlrabi	X			
Parsley	X**			X
Parsnips	X	X		
Peas		X		X
Peppers, Hot , Sweet	X**	X		X
Potatoes	X*			
Potatoes, Sweet	X	X		
Pumpkins	X*	X		
Rutabagas	X			X
Salsify	X			
Tomatoes	X	X*		
Winter Radishes	X			
Winter Squash	X*	X		X

* Preferred Method ** Dried

Table 2. Preservation Methods for Specific Fruits

Commodity	Store	Can	Juice/ Preserves	Freeze
Apples	X	X	X	
Berries			X	X
Cherries		X		X
Citrus Fruits	X		X	
Cranberries, Currants			X	X
Grapes	X		X	
Peaches		X		
Pears	X	X		

As well, certain varieties of these products have been developed which are good for eating fresh, others for canning, freezing, or storing. Late-maturing varieties are the ones generally suitable for storage, as you are dependent on cold weather to achieve a state of dormancy.

Select which produce you wish to have available and which method will be most appropriate. Whichever method is chosen, you will find that produce harvested at peak maturity which is stored or processed *immediately* will have better flavor and higher nutritional value than that harvested at a less optimum stage of maturity.

Food preservation methods also vary in the amount of effort involved, the necessary equipment, the fuel consumed, the potential savings in food costs, and in the food quality satisfaction (Table 3).

Table 3. Comparison of Food Preservation Methods

Method	Time	Energy		Dollar Cost	Quality Satisfaction
		Fuel	Labor		
Freezing	Minimal	High	Low	Very High	Very High
Canning	Moderate	Moderate	High	Moderate	Moderate to High
Drying	High	Low to High	Moderate	Moderate to High	Low to High
Pickling	High	Low	Moderate	Moderate	High
Storage	Low	Low	Moderate	Low to Moderate	Moderate to High

R. Klippstein, *Economics of Home Food Preservation*, Yearbook of Agriculture, 1977. pp.310-312

Make use of Cooperative Extension Services in your area for further information about gardening, buying food in bulk, and food preservation methods.

Freezing

The fact that there are over 20 million home freezers operating in the United States today attests to its convenience, simplicity, and ability to handle the greatest array of foods with few risks. The processing involved is considerably simpler,

less time-consuming, and less likely to produce error than canning. Frozen foods are seldom involved in food poisoning or spoilage, although they are subject to losses from mechanical breakdown or power failure. Besides the initial cost of the freezer, energy costs will increase your electric bill by at least several dollars each month. The freezer must be kept stocked at all times to run efficiently. It is easy to keep a full freezer during the harvest season, but more difficult in late winter and spring, unless meat and prepared foods are a large portion of the produce being frozen. While freezing is a convenience, it cannot be justified as a means of reducing food costs unless the produce is home grown or can be purchased at very attractive prices.

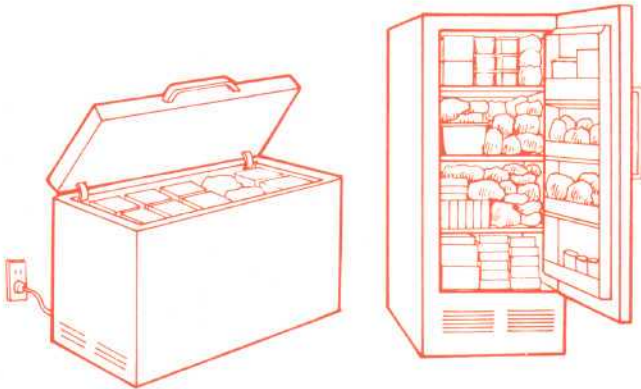

Canning

Canning requires organized and intensive kitchen production during processing, and a cool, dark, and dry storage location where canned goods will not freeze. Equipment for canning tomatoes is minimal, but equipment for preserving other vegetables, fruits and meat is more costly.

Canning is not a difficult technique, but instructions must be followed precisely to avoid spoilage and possible food poisoning. Canning is more labor intensive than freezing, but expenses are fairly low, and once the period of intense activity is over, it is a lasting and simple method of keeping foods.



Drying

In hot, dry climates fruits and vegetables can be sun-dried. Solar drying is unpredictable, however, unless temperatures are very high and the relative humidity low, otherwise spoilage may occur before drying is achieved. In the Northeast, for most produce it may be necessary to use artificial heat and circulate air over the food. This can be accomplished at moderate expense.

Dried fruits and vegetables are subject to darkening, loss of flavor, loss of vitamin content, insect damage and mold. Most deterioration can be prevented by storage at 32-45°F with low relative humidity (55-60%).

Most herbs can be air-dried. Generally speaking, you pull the entire plant when it is mature. After washing thoroughly, hang the herbs in the sun for several hours until they begin to wilt and dry. Then place inside paper bags with a few perforations to increase air circulation, and hang the bags in a warm airy place such as a warm attic until drying is accomplished.

Preserving seasonal foods by drying conserves storage space. Containers of dried foods should be stored in a dry, cool and dark place. Low storage temperatures will extend the shelf life of the stored product.

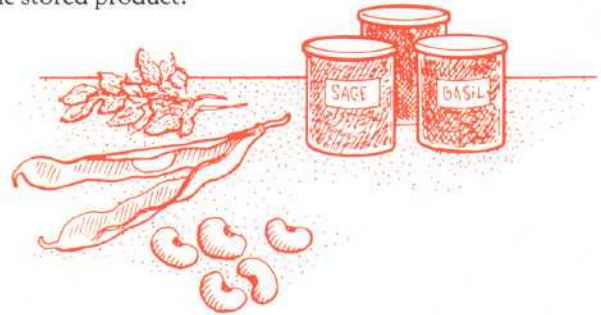

Storage

Storage works in the winter months, in conjunction with cold weather, when produce at the supermarket is expensive and least appetizing, and when it is *most* convenient to have a supply of basics at home. Storage can also provide the option of processing food in winter and early spring by canning or freezing, to make crops usable through spring and summer until harvest.



It is easy to do, since no processing is involved, but storage is only useful for certain fruits and vegetables, and these for varying lengths of time. Expected storage duration must be taken into account when planning the amount of a particular product you will store. (Figure 1).

Figure 1. Average Storage Duration for Commonly Stored Produce

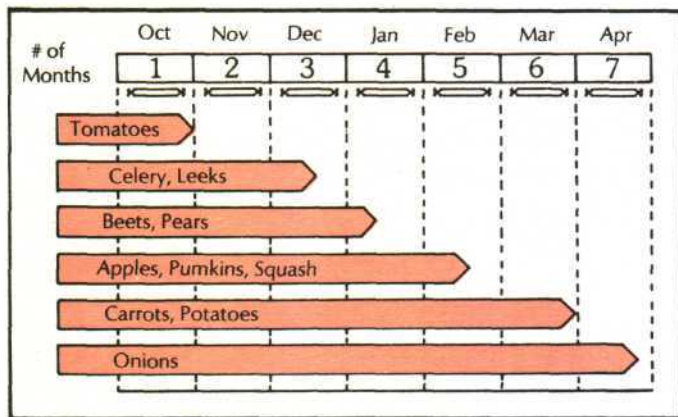

Storage has few hidden dangers; since you are dealing with whole fruits and vegetables, you know by look, smell, and feel if the food is spoiled. Molds may be considered dangerous, so it is advisable never to taste potentially spoiled foods.

Storage can be done on a small scale with a limited investment. There is no costly equipment and no ongoing expenses. Many of the materials used for packing and insulating produce can be recycled as mulch in the garden. Storage on a large scale can be accomplished by constructing a storage room (basement room or exterior root cellar) for the cost approximately equivalent to a freezer. Once constructed, however, the storage room will operate with few ongoing expenses and a moderate amount of labor.

Storage makes use of cold weather for refrigeration and includes any method of preserving food that does not require processing.

The Best Conditions for Storage

Many fruits and vegetables can be stored for extended periods of time provided they are given the proper *temperature* and *moisture* conditions that will not allow them to freeze, or to complete their natural cycle to decomposition. Crops held in storage are still living plants that are made dormant by their environment.

Products suited to storage can be grouped according to the conditions best for each - cold (32-40°F) and very moist

(90-95% relative humidity); cold (32-40°F) and moist (80-90% relative humidity); warm (50-55°F) and dry (60-75% relative humidity); and cool (32-50°F) and dry (60-70% relative humidity).

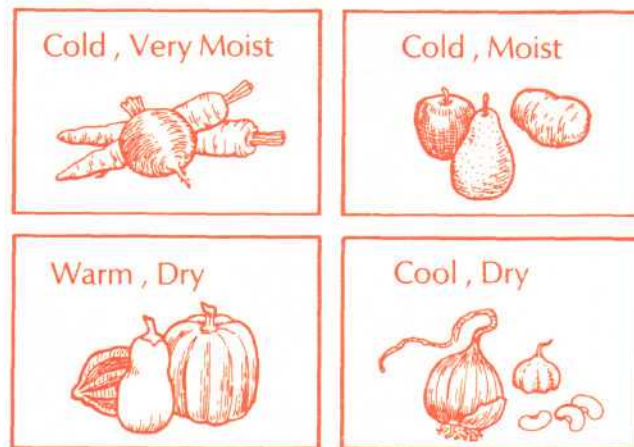

While there are optimum temperature and moisture conditions at which certain stored foods can last, some variations of conditions can be tolerated. Less than optimum conditions do not spoil the food, as freezing will, they just shorten the storage time. There are no hard and fast rules to achieve storage conditions, as climatic conditions vary widely.

The storage described in this publication will be feasible if you live in an area where outdoor temperatures during the winter average 30°F or lower (Figure 2).

Figure 2. Region most suited for Winter Storage

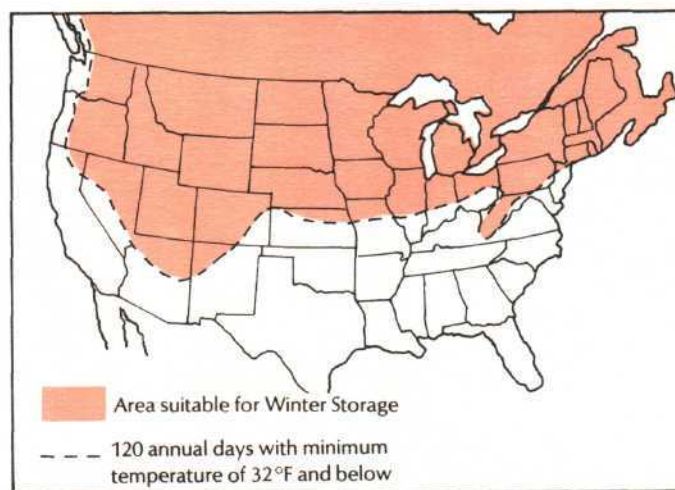

Caution should be used in interpreting this map. Sharp changes may occur in short distances due to altitude, land slope, bodies of water, urban heat effect, vegetative cover, etc.

Storage works in the winter months when it is most convenient to have a supply of basics at home.

II Outdoor Storages

Vegetables that require cool to cold, moist surroundings can be stored in any one of several types of outdoor storages. Earthen storages, from simple mounds to more elaborate root cellars, naturally provide cool, moist, dark, and even conditions for a fairly long period of time. All outdoor storages have the disadvantage of sometimes being inaccessible and are often subject to damage by rodents and other vermin.

To be successful, any outdoor storage must have thorough drainage. A storage into which water backs up or settles will not keep fruit and vegetables well and may result in their total loss. In soils that are not naturally well-drained provision must be made for the removal of excess water.

Some vegetables can be stored in the garden where they grew, or in mounds, pits, or buried containers. Usually the produce must be insulated for protection from frost and fluctuating temperatures. Insulating materials commonly used are straw, hay, dry leaves, corn stalks or wood shavings, and some soil. Be sure that the insulating materials used are not contaminated with pesticides.

To be successful any outdoor storage must have thorough drainage.

In-Garden Storage

It is possible to leave some root crops, such as carrots, turnips, and parsnips in the garden where they grew for part or all of the winter. The secret of winter gardening is to take advantage of late-maturing varieties of vegetables that can tolerate a fair amount of freezing, then help them along with careful mulching.

When the ground begins to freeze in the late fall, cover them with a heavy mulch of straw, hay, or dry leaves. The produce can be difficult to dig out of the frozen ground, but it will not be adversely affected by heavy frosts.

Other crops, such as beets, cabbage, Chinese cabbage, cauliflower, celery, endive, cos lettuce, kale, leeks, and onions can withstand the *early* frosts and can be stored for several weeks under a heavy mulch.

Parsnips, horseradish and turnips are *improved* in flavor by light freezing (at temperatures between 28-34°F, starch will change to sugar). Mulching will make mid-winter digging easier.

Figure 3. In-Garden Storage

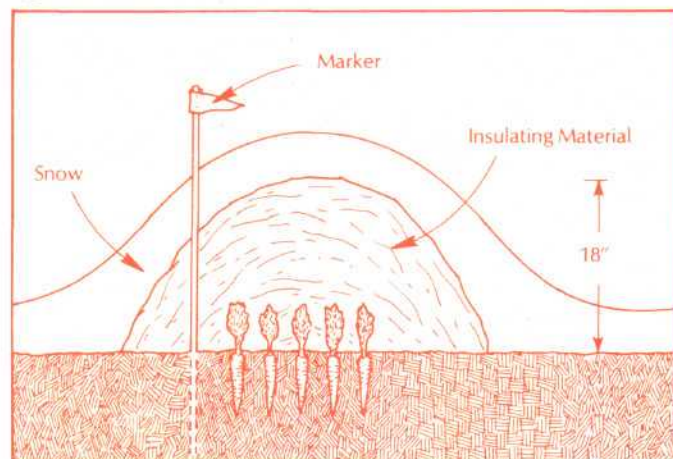

To assure a large supply of these frost-resistant vegetables, plant in mid-summer so they will mature in late fall, and in a location where they will be accessible for winter removal.

Insulating Materials

- Straw
- Dry Leaves
- Wood Shavings
- Hay
- Corn Stalks
- Soil



Surface Storages

Mounds or pits are a very economical way to store cabbage and root crops (carrots, beets, celeriac, kohlrabi, rutabagas, turnips, and winter radishes). Root crops withstand autumn frosts and are better off in the garden until nights are cold enough to permit proper storage temperatures.

Select a well-drained location, make a shallow excavation (from 6-10" deep) and line it with insulating material. Placing the produce partly below the surface ensures better frost protection, but increases the danger of excess water. A ditch around the perimeter of storages will help to remove surface water.

Figure 4. Typical Surface Storages

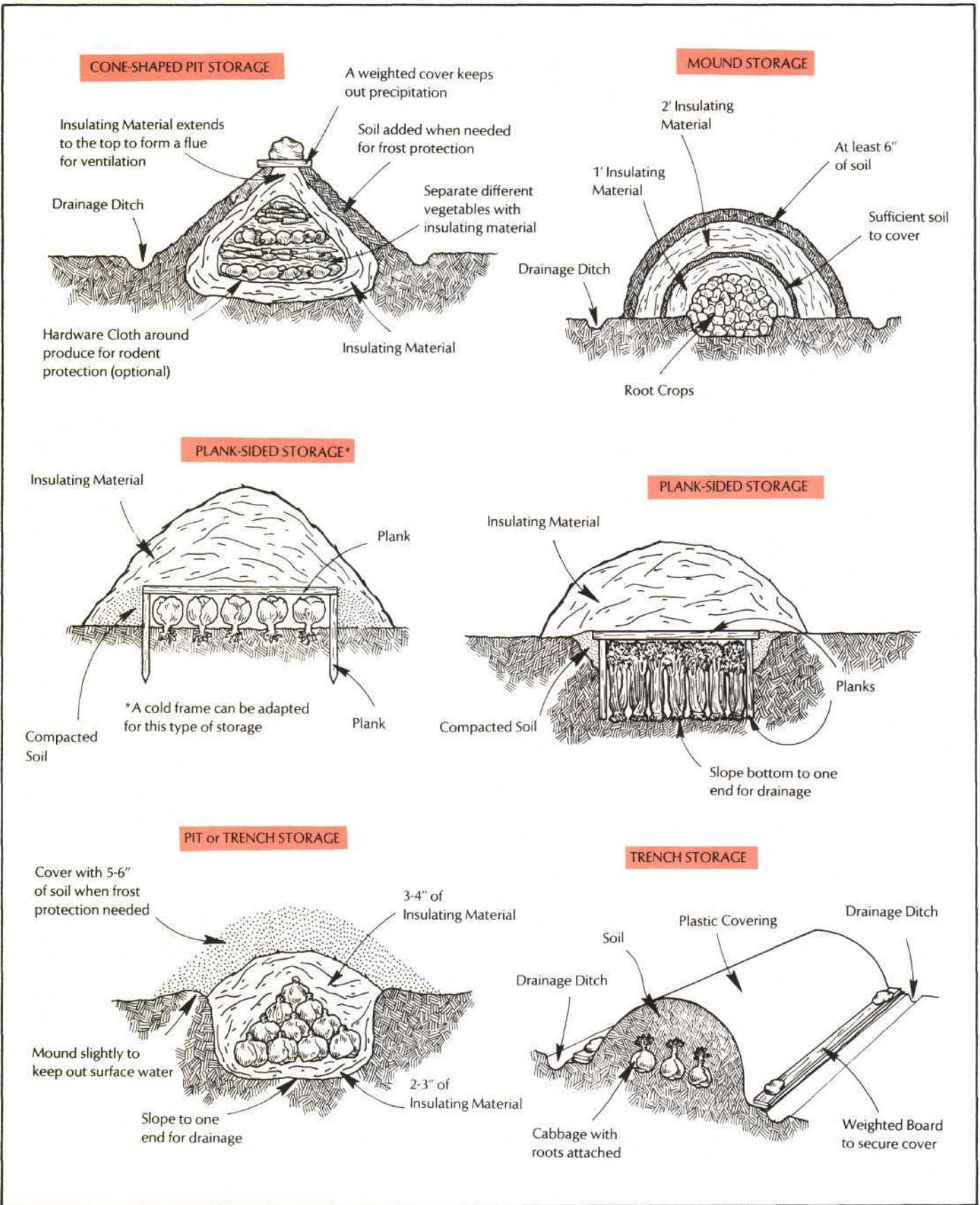

The vegetables should be placed in storage just before freezing weather. The mound or pit should be covered with insulating material early in the morning after being cooled by the night air. The final covering of soil is added only when frost protection is needed.

Some ventilation is needed, even in small pits, if they are covered with soil. This can be accomplished by extending a small section of the insulating material up through the soil to form a small flue (Figure 4). A weighted down cover over the flue keeps out precipitation. For larger mounds, an inverted hamper can be placed at the top, or boards or stakes can be inserted through the pile of vegetables and covered at the top to keep moisture from entering. This ventilation is most necessary in the late fall before extreme cold weather has set in.

Protection against rodents should be considered in pits or trenches but it is even more important in outdoor storage cellars and buried containers where rodents might seek shelter, as well as food supply. If the vegetables are stacked on 1/4" hardware cloth, this will deter winter feasting by rodents. Tin snips and leather gloves are necessary for handling hardware cloth.

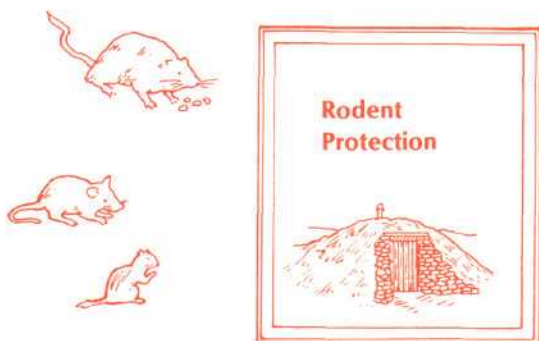

Vegetables keep very well in pits and mounds, but once they are opened it is desirable to remove the entire contents. If only part of the produce is removed, care must be taken to pack the insulating material well into the opening and to cover it carefully with earth. Small pits can be planned to supply produce for a certain period of time, one or two weeks at most, as the produce will not keep as long after removal from storage as will freshly harvested produce. Root crops can be mixed, but should be separated with mulch to prevent cross-transfer of odors.

Before snow cover, surface storages can be covered with material such as burlap, an old rug, or canvas to make removal easier in winter. Locate storages in a different place each year as they can become contaminated with spores or bacteria.

Trench Storages

A plank-sided trench is suitable for storing celery, cabbage, Chinese cabbage, and root crops. A trench deep enough to hold the crop is dug in well-drained soil. The bottom can be sloped toward one end for drainage. Line the sides with planks, and line the bottom and between different kinds of vegetables with layers of insulating material. Then cover the trench with planks and compact the soil where the top meets the sides to provide a good seal. Roofing paper or plastic over the top helps keep out water and dirt. As the danger of freezing weather approaches, a 2-3 foot layer of insulating material should be placed over the top with some dirt to hold it in place.

A cold frame can also be converted to a storage area of this type if the sash is replaced with planks or boards.

When placing celery and Chinese cabbage in trenches, pack them close together leaving considerable soil attached to the roots. Water the roots when they are in place and avoid getting water on the leaves. Unless the soil is very dry at the time of storage, or extended warm weather should follow, it will not be necessary to add more water.

One of the most difficult steps in successful storage is to keep the produce in prime condition from the time of optimum maturity until the night temperature is low enough to cool the storage place.

Buried Containers

An insulated box or other container can be buried in a well-drained area. Buried containers are more easily opened and closed than mounds and trenches. This type of storage could be located in a breezeway, shed, or garage for easier access and greater frost protection. However, if you plan to store food in or near a garage, it must be more carefully wrapped and protected from car fumes, which are easily picked up by produce.

A 20 gallon trash can, buried in the ground, makes a convenient and economical storage for many kinds of vegetables. Metal cans are more rodent proof than plastic. Several holes should be made in the bottom to facilitate drainage. A wooden barrel, steel drum, or several pieces of drain tile may also be used. The container must be free of material that might impart off-flavor to the produce. **Never use drums or containers that might have contained pesticides or other chemicals.**

Figure 5. Typical Buried Containers

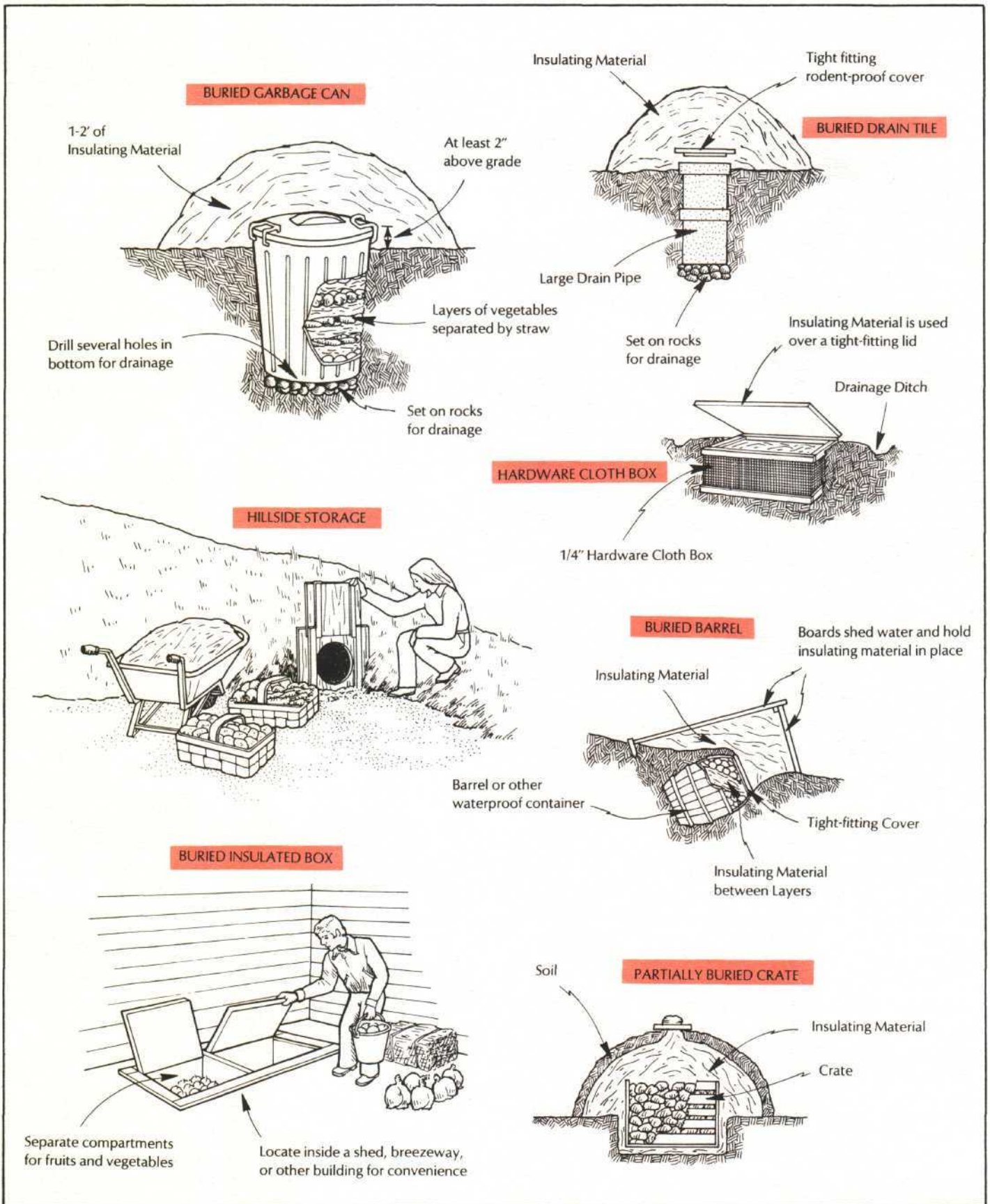

Select an area where the ground is well drained and dig a hole slightly larger than the container. A few bricks or stones under the container will aid drainage. Place the produce in the container in layers with enough straw or similar material to separate layers. Layering is especially important if more than one kind of vegetable is to be stored in the same container.

The container can be built into a hillside, either horizontally, or at a slight angle. In mild climates where temperatures rarely go below 30°F, the container need only be covered with a 1' layer of insulating material, then weighted down with 1' of soil. In more wintry areas, insulate the barrel all around and cover with more soil for frost protection. A sliding door is useful for horizontally buried containers. Fasten a hardware cloth screen for rodent protection between the opening and the cover.

Outdoor Storage Cellars

Outdoor storage cellars are generally more efficient than basement storage rooms since they have the advantage of a dirt floor and naturally stay cool and moist over a long period of time, but they are often less accessible and convenient than their indoor counterparts.

Before the days of large scale food distribution and supermarkets, people used root cellars extensively to maintain produce from harvest through the winter. They were built under houses where there was a dirt floor and isolation from heat sources, or as a separate exterior unit. With the advent of refrigeration and central heating, the old-fashioned root cellar has virtually disappeared.

Before the days of large scale food distribution people used root cellars extensively to maintain produce from harvest throughout the winter.

Outdoor cellars can be constructed partly or entirely below ground. Below ground storages are protected from sun heat on four sides, but require steps leading into the storage which must be covered to exclude snow. The partly below ground cellar has soil banked on three sides, so the areas not covered with soil should be well insulated. The door to outdoor cellars must be well insulated and carefully built to exclude vermin, which are particularly attracted to outdoor cellars.

The structure must be strong enough to support the weight of the earth over the roof. In the Northeast, 2-3' of banked soil, or 1-2' of soil plus 4-6" of fiberglass insulation is necessary for

Figure 6. Outdoor Storage Cellars

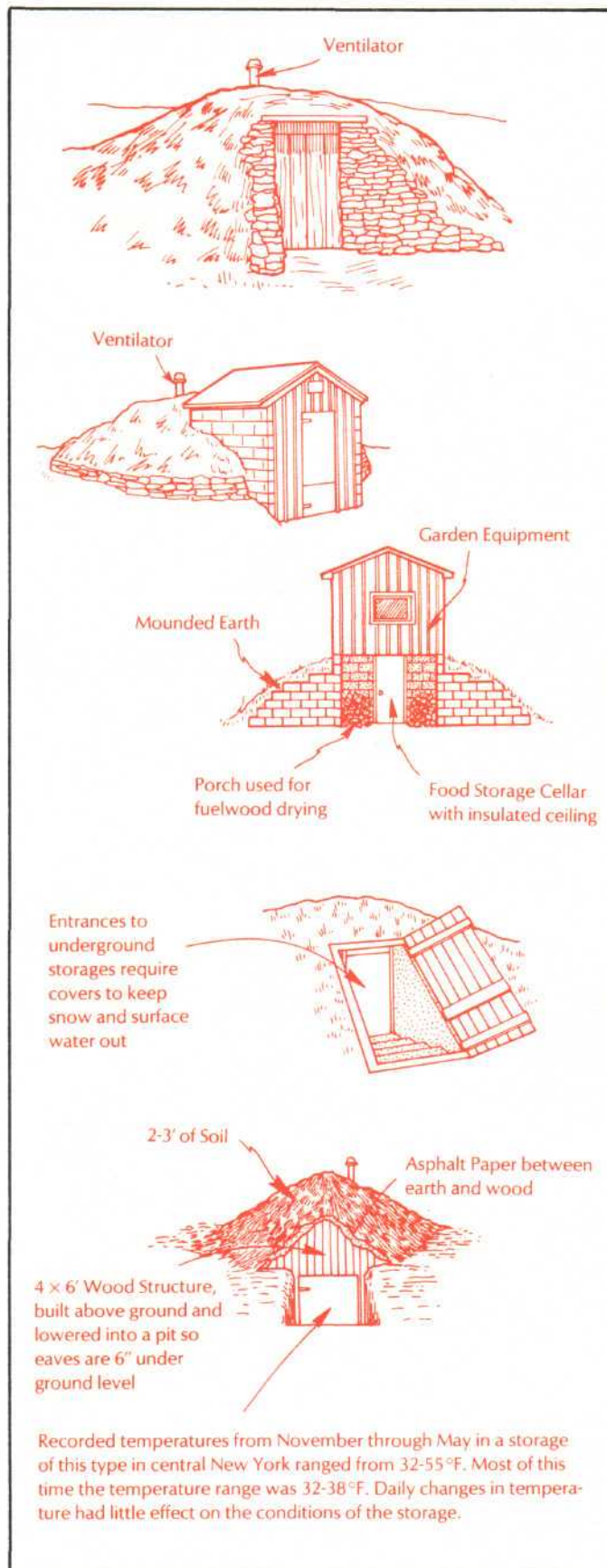

Recorded temperatures from November through May in a storage of this type in central New York ranged from 32-55°F. Most of this time the temperature range was 32-38°F. Daily changes in temperature had little effect on the conditions of the storage.

frost protection. Heavy corrugated curved metal can be used as the roof support. Block or stone are generally used for the walls. An earth floor is best for maintaining high humidity levels since it accepts and gives up water easily and slowly.

Corrugated
Metal Roof

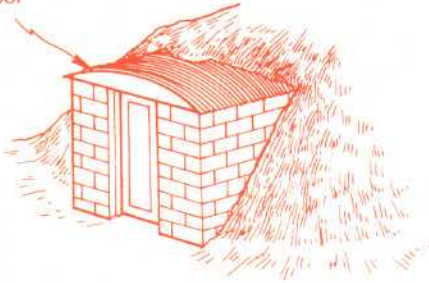

A ventilation system is essential for air circulation and regulation of temperature (see Section III - Operation of Storage Room). It must be covered with wire screen to prevent birds and small animals from entering.

Outdoor cellars can be simple, functional, and hidden from view, or more permanent and elaborate. They can be incorporated into the design of other buildings, or designed to serve several functions, such as storage of garden equipment.

If large amounts of fruits and vegetables are to be stored it is advisable to divide the storage into two areas, each with its own ventilation system.

Outbuildings

Sheds, breezeways, enclosed porches, and garages can be used to store insulated containers which are not buried. A foam plastic chest makes a good small storage unit. Use separate containers for fruits and vegetables. An uninsulated container stored in an unheated area should have 6-8" of insulating material on the bottom, sides, and top, with 2-3" between layers. Additional blankets or other coverings may be necessary to ensure protection against freezing.

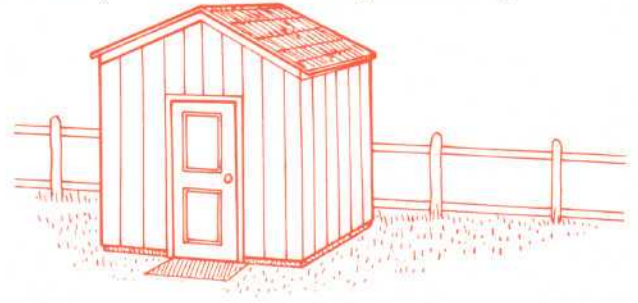

III Indoor Storages

There are many areas in dwellings that naturally provide, or can be adapted to provide, a variety of temperature and moisture conditions for storage (Figure 7). Assess your specific situation; if possible, use a thermometer to monitor temperatures in various areas of your building during the fall and winter to find locations that are convenient and most readily adaptable for food storage. Any spot that is sufficiently and evenly cool (32-60°F) can be adapted for some types of food storage. The relative humidity of these locations will affect what type of produce can be stored.

Buildings are often overheated in the winter, and finding a cool spot is not always easy. Basements are generally the most logical place to adapt. Older homes are often less well-insulated, and have pantries, back halls, enclosed porches or breezeways, sheds, and bulkheads which are adaptable to storage. Home heated with wood stoves will be readily adaptable since they have a central area of radiant warmth, and peripheral areas which are considerably cooler.

Figure 7. Typical Indoor Storage Locations

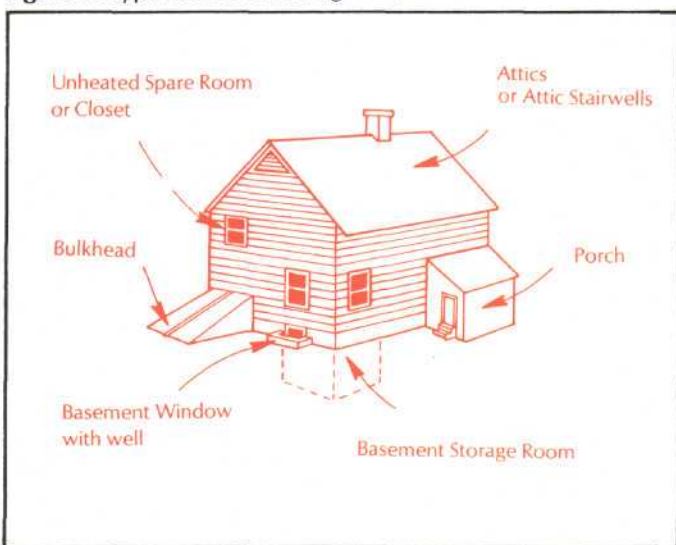

Windows with Wells

Basement windows which open inward (to the basement) and have exterior wells can be small storage areas, if the well is covered after it is cool, and insulated with bales of hay or other insulating material. These areas provide moderately moist conditions and can be used to store a variety of root crops.

Bulkhead

A stairwell or bulkhead into the basement is generally not used for access to the basement during the winter, and can be adapted for storage. The inside door must be insulated to keep out basement heat, and the outside door should be banked with hay, or insulated to prevent both freezing and unseasonal hot sun from spoiling the produce (Figure 8).

Experiment with a thermometer to determine the best levels for the crops you are storing. If the air is too dry, cover the floor and steps with wet sand or sawdust, or saturate pails of sand with water.

Figure 8. Bulkhead Storage

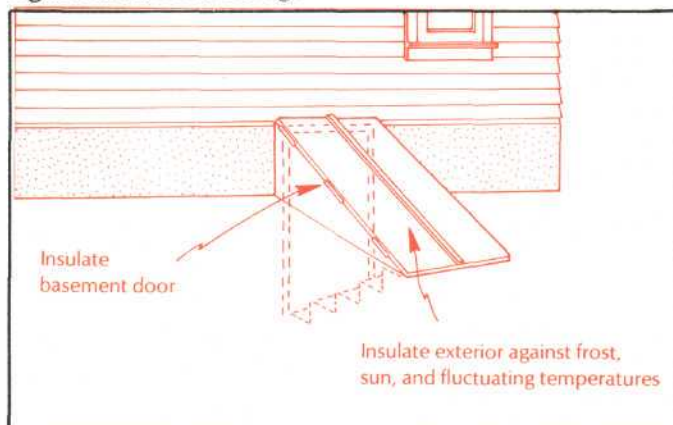

Basement Storage Room

Modern basements with furnaces are generally at least 50-60°F and dry. Long term storage for most fruits and vegetables requires temperatures close to 32°F with moist atmosphere. In order to achieve these conditions, it will be necessary to construct a partition through which heat and moisture cannot readily pass.

Modern Basements

Basements may have a whole spectrum of conditions adaptable to storage. The area close to the furnace may be suitable for storing winter squash and pumpkins. There may be cool dry areas suitable for storing dried foods and canned goods.

Long-term storage for most fruits and vegetables require temperatures close to 32°F with moist atmosphere.

Location

Locate the storage, if possible, in the coldest part of the basement, away from the furnace. The north and east sides of the house are preferred. Avoid heat ducts and hot water pipes, otherwise they must be insulated to keep heat out of the storage area. The room should have an outside window through which cold air may be admitted.

Figure 9. Basement Storage Location

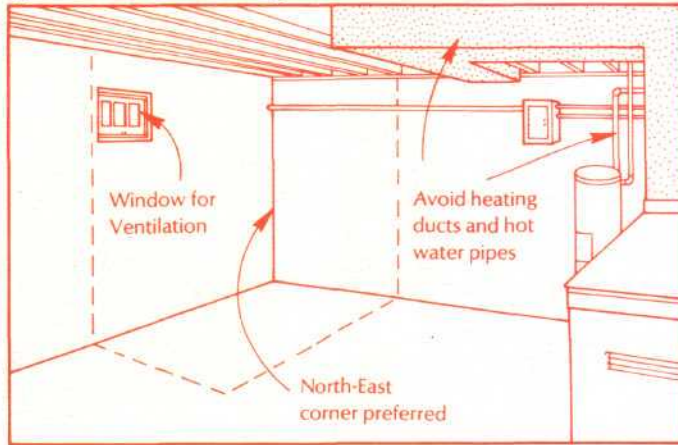

Size

A room 4' x 4' to 6' by 6' is large enough for most households (Figure 12). A small room is less expensive to construct; but, more important, the atmosphere is easier to control. The walls and door should be very tight, as even a small opening is likely to greatly reduce the efficiency of the storage.

Figure 10. Plan of a Basement Storage Room.

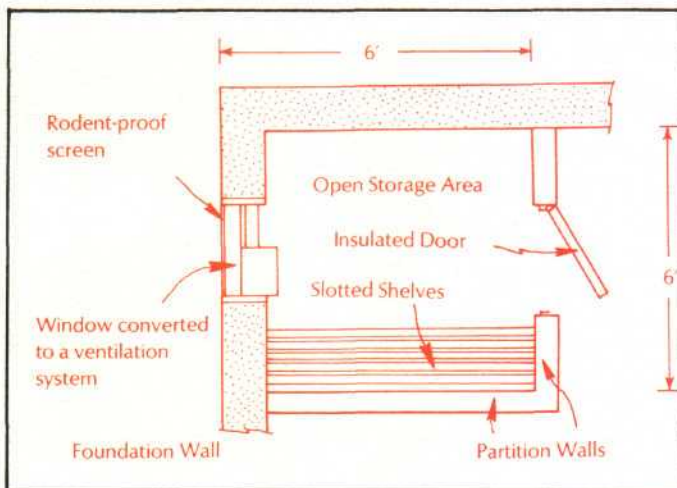
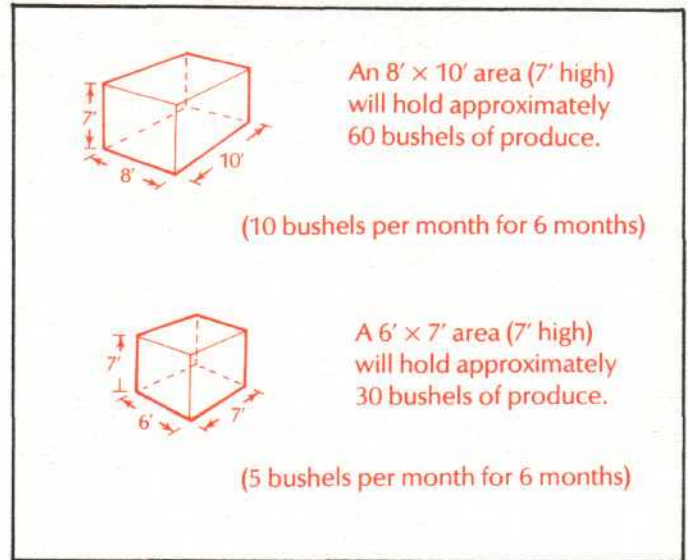

Figure 11. Sizing a Basement Storage Room



A small storage is less expensive to construct and the atmosphere will be easier to control.

Insulation and Vapor Barriers

The exterior walls are insulated by the earth. However, if the earth is more than one foot below the ceiling of the storage, more earth (or insulation) should be added to bring it up to this level.

The partition walls can be constructed of 2 x 4 studs, 16" or 24" on center, and insulated with 3 1/2" thick (R-11) fiberglass insulation. Faced insulation should have the vapor barrier closest to the warm side of the storage. If unfaced insulation is used, a vapor barrier such as 6 mil thick polyethylene can be used to prevent condensation. The ceiling, too, requires a vapor barrier and insulation.

Construction

Use 3/8" exterior plywood or particle board for the sheathing on the interior. The exterior can be plywood or gypsum board (wall board) as it does not have to be washable or moisture resistant.

It is advisable that partition walls be built several inches off the floor, which will often have moisture on it. This can be accomplished by 1) using a wood floor plate which has been pressure treated with a copper based preservative recommended for ground contact¹, 2) by fastening the floor plate to

¹Copper water-borne salt preservatives, typically green in color, are best for this application. Creosote and penta should not be used because toxic fumes could affect the stored product.

Figure 12. Insulation and Vapor Barriers for a Basement Storage

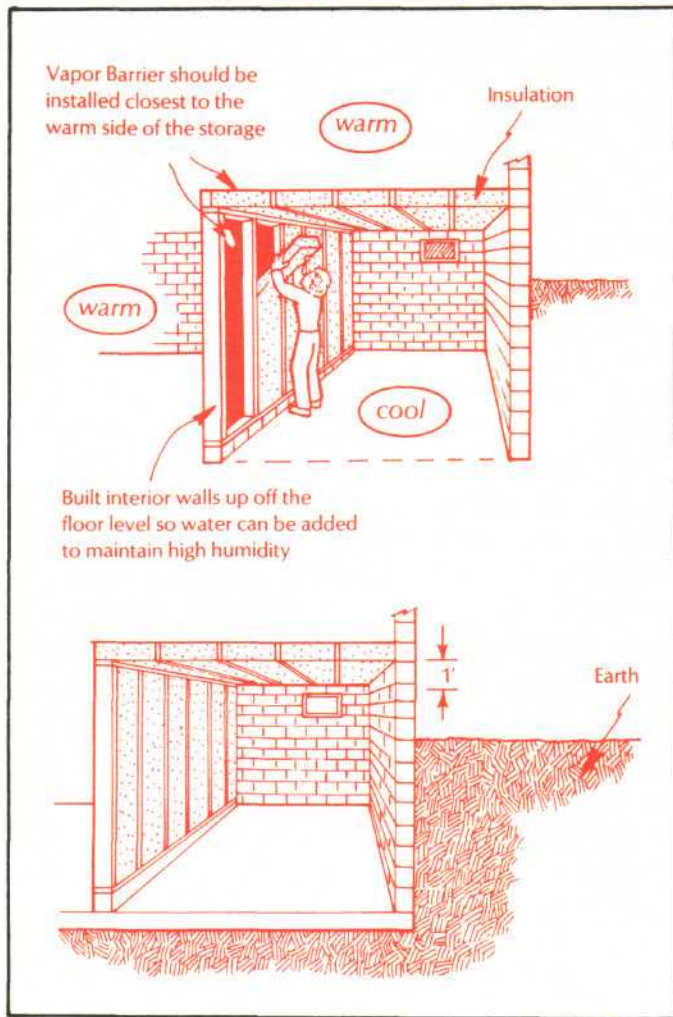

concrete blocks with cores filled and mortar added, or 3) by laying the floor plate on bricks, on edge, and filling the space with mortar, slushed in from the inside.

The door should be insulated. It can be framed with 2 x 2 studs, faced on each side with 1/4" plywood and the center filled with insulation.

Ventilation System

The window must be insulated and shaded to exclude light. Opening and closing a standard window adds cool air to the room, but better air distribution is achieved if you divide the window area so cool air enters the lower part of the window into a duct which extends to about one foot from the floor level. Then the warm storage air will rise by natural convection to leave through the upper opening.

Figure 13. Ventilation System for a Basement Storage

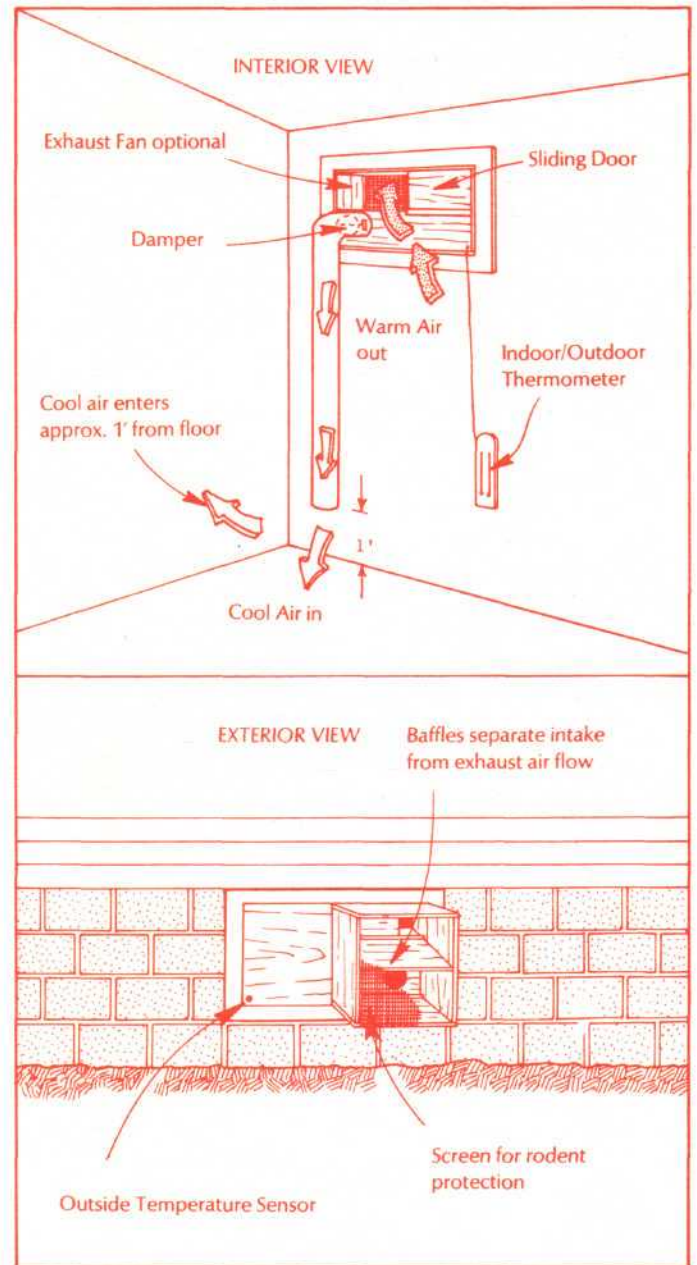

Rodent Protection

Any food storage area must be protected from mice and rats, as they can ruin or foul much of the stored produce in a short time. Rodents usually come into houses when the weather turns cold in the fall. Eliminate areas where rodents hide by cleaning out trash, piles of lumber, and weeds around buildings. Foundations and floors of concrete deter rodents, but sheathings on the partition walls must be carefully installed so there are no openings at the floor or ceiling. Remember that young mice can crawl through a quarter-inch hole.

If you anticipate that you will have rodent problems, you may want to provide extra protection. Consider using mouse traps, or a poison feeding program, being careful to keep bait out of reach of children and pets. The doorway should have a tightly fitted screen door as well as an insulated door. The screen will permit free passage of air, as necessary, and, at the same time, keep out rodents. The frame walls, unless covered with cement-asbestos board, should be protected to a height of 15-24" (from the floor) with sheet metal. In a cellar with a concrete or flagstone floor to which the sill of the partition fits tightly, no other vermin-proofing will be necessary.

Shelves and Containers

Shelves and bins should be built with slats to permit air circulation. The bottom shelf should be at least 4" off the floor so that the floor can be cleaned under the shelf, and so water can be poured on the floor to maintain high humidity.

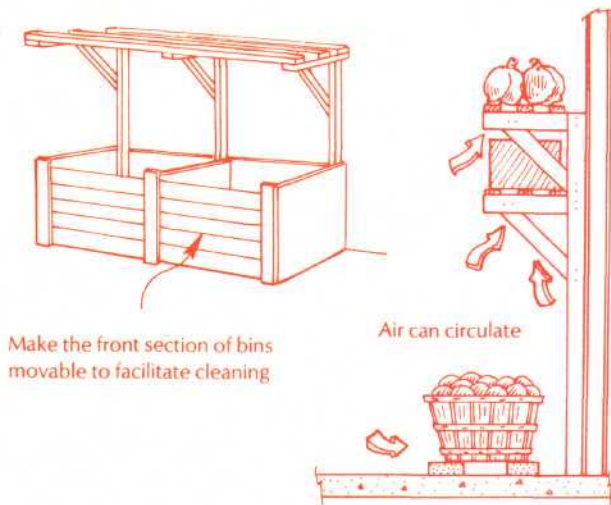
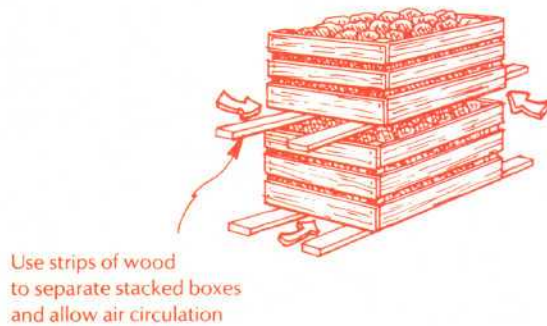
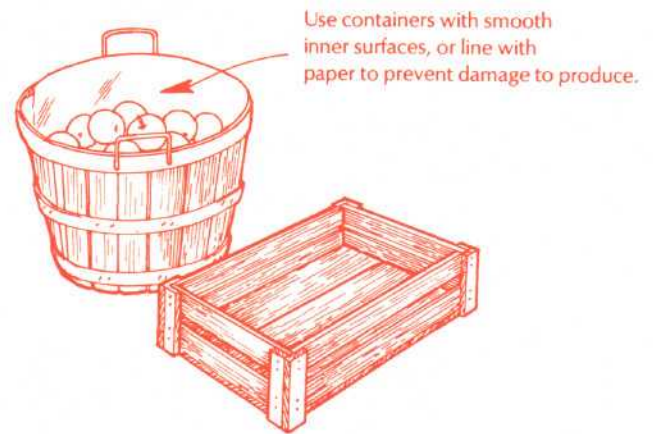
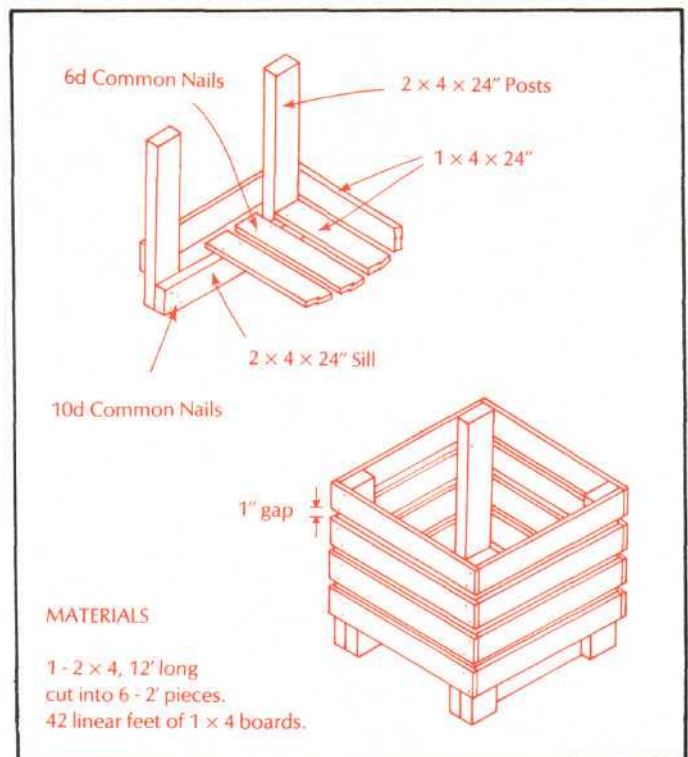

Figure 14. Construction Details for a 4-bushel Crate



Separating Fruits and Vegetables

If you intend to store a large quantity of fruits and vegetables, it is advisable to add a central partition so that there are two storage areas, ideally each with its own ventilation system. Ethylene gas produced by apples can cause potatoes to sprout, while cabbage and turnip can give their odors to pears and apples. At least store fruits and vegetables as far away from each other as possible. Wrapping fruits individually also helps to prevent cross-transfer of odors.

Movable containers are preferred to built-in bins as they are easier to clean and air. When stacking containers, use wood strips between containers to allow air circulation. Produce can be stored in bushel basekets, crates, barrels, cardboard boxes, sturdy plastic laundry baskets, or wooden containers can be constructed. Use containers that have smooth inner surfaces, or line with heavy paper. Protruding wire staples in baskets and hampers are particularly damaging.

Operation of a Storage Room

The most important factors for operating an indoor storage are temperature and moisture control, culling and sanitation.

Temperature Control. Hang one thermometer in the coolest spot in the storage, and another outside an accessible window for guidance in establishing the correct temperature. Thermometers which register both inside and outside temperatures are also available.

In the early fall, when the nights are cool, and the days warm, open the ventilators only at night. As the weather becomes cooler, the ventilators may be opened as needed. Outdoor temperatures well below 32°F are necessary to cool the storage air to 32°F and maintain that temperature. A manually controlled ventilation system requires considerable attention during the fall, for checking temperature and adjusting vents.

Once winter sets in, the storage may operate at the desired temperature with little or no ventilation. In very cold weather it may be necessary to open the storage door slightly to add warm air from the basement. Additional heat could also be provided by hanging a 100 watt bulb near the floor. If you keep a watchful eye on the storage in very cold weather, it is useful to keep a pail of water in the storage; water will freeze over before the crops will be damaged.

In very cold weather it may be necessary to add warm air to the storage to protect produce from freezing.

Manual operation of the ventilation system is inexpensive provided you have the time to check temperatures and make the necessary adjustments to vents. Once the storage is cooled there is more risk of freezing injury to the stored produce. It is helpful to have a low-temperature warning system such as a thermostat in the storage room connected to a buzzer located in your living quarters.

Automatic controls are more expensive but they eliminate the need for daily adjustments and they reduce losses due to human error. A small thermostatically controlled fan in the vent duct can help to establish the correct temperature automatically (weather cooperating). If louvers are used be sure they do not become jammed with ice or snow.

Temperatures will vary within the storage room. Remember that heat rises, so produce requiring higher temperatures should be stored on the upper shelves.

A manually controlled ventilation system requires considerable attention during the fall, to establish the correct temperature.

Mechanical Cooling. For convenient and accurate, but more expensive temperature control, an old refrigerator can be used. The condenser coils must be outside the storage area since they give off heat. The refrigerator door must be removed and a fan installed to circulate the cool air.

Refrigeration costs more than natural cooling, but it provides the most positive method of temperature control with little attention. It should be considered if there is a possibility that minimum outside temperatures will be higher than 40°F during much of the storage period. Refrigeration could also be used to provide supplemental cooling in the fall until outside temperatures are low enough to cool the storage properly.

Figure 15. Mechanical Refrigeration for a Basement Storage Room

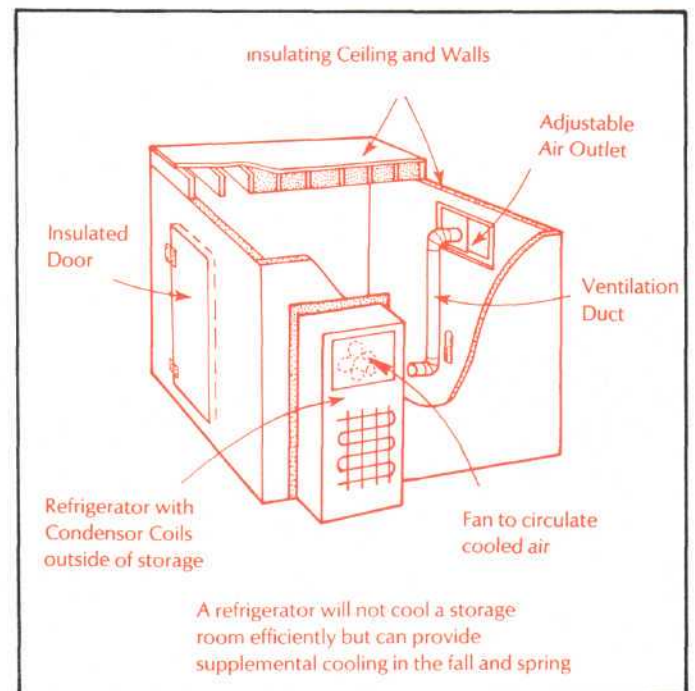

Moisture Control. Most fruits and vegetables are about 85-95% water. Unless the humidity is high (about 80-90%), many kinds of produce will rapidly shrivel and become unusable. Retention of moisture will also be influenced by methods of packing for storage (see Section IV).

A simple and effective method of maintaining high humidity is to keep the floor wet by pouring water on it at intervals.

Much more water is needed than is usually realized; merely placing pails of water in the storage will not be adequate. A layer of gravel on the floor will increase the surface area for greater evaporation, or water can be added directly to the concrete floor. A slotted pallet or pieces of wood on the floor will keep your feet dry when you are in the storage. Be sure to keep crates and bins away from direct contact with the floor.

Relative humidity is the percentage of moisture in the atmosphere at a given time as related to the maximum amount (100%) that could be retained at that temperature. Ventilating the storage to cool it results in a loss of relative humidity. Therefore, more water will be required in the fall, when ventilation is considerable and the produce still has some field heat, than during the winter when ventilation is slight. A cellar filled to capacity can maintain a high humidity easier than a partially empty one, so more water will be needed to boost the relative humidity in the late winter and early spring.

Excessive humidity is conducive to mold and decay organisms, particularly when water droplets form on the surface of the product. Plastic bags and liners used for moisture retention should always be perforated at regular intervals to permit air circulation and prevent condensation.

Hygrometers are available for measuring relative humidity, but they are optional. Remember that a humidity level of 95% is almost rainfall, and rather difficult to achieve indoors. A word of caution - subsurface or ground water from rain and melting snow (seepage) should not be allowed to enter a food storage, as this may contaminate the produce.

Culling. Regularly examine produce for any signs of shriveling, softness, decay, mold, mustiness, or other odors. Immediately remove and discard any showing signs of decay, as spoilage and mustiness (a sign of spore contamination) will spread quickly to other produce. This check can generally be done when you are removing produce for table use. Do not pile produce too deeply in storage containers, or culling will be difficult; excessive handling can do more harm than good.

Sanitation. At least once a year, remove all containers from the storage, to clean and air them in the sun. The room itself should also be thoroughly aired, cleaned and washed down with a disinfectant, such as chlorine bleach, to kill off any molds or bacteria which could lie dormant and ruin future crops.

The most important factors for operating a storage room are temperature and moisture control, culling, and sanitation.

Attics

Conditions within attics vary. If the roof is not insulated, and ventilation is minimal, attics collect and hold solar heat, and temperatures will fluctuate considerably due to outside conditions. However, if the floor is insulated and the attic well-ventilated, conditions will be cold and dry, so it will be suitable for storage of dried foods which are not harmed by freezing. Monitor temperatures carefully before using attics as a dry storage area.

If there is a stairwell leading to the attic this can be a cool, dark, draft-free location which is convenient for storage of onions, and dry beans. This stairwell will be less susceptible to freezing than the attic proper.

Attics can be a good environment in the fall for drying herbs, beans, or tree nuts, such as walnuts and hickory nuts.

Figure 16. Attic Storage

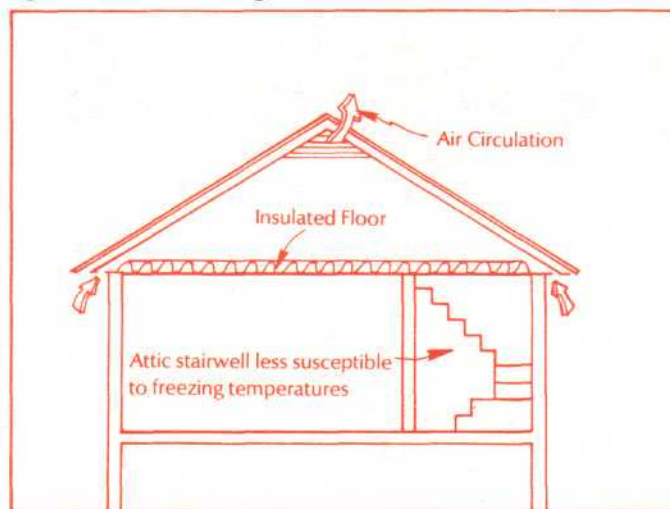

Pantries

At one time this dark, cool, dry room off the kitchen was considered indispensable for food storage. Many foods will stay fresh much longer, even if you succeed in lowering the temperature to only 60-65°F. The pantry is useful for short-term storage of potatoes and onions, and long-term storage of spices, vegetable oils, nuts, and commercially canned goods. Low storage temperatures extend the shelf life of dried foods (dried beans, herbs, dried fruits and vegetables) and other products such as coffee, flour, rice, pasta, and cereals. Store in containers with tight-fitting lids.

Unheated Rooms and Closets

Unheated areas in the home may be useful as cool to cold dry storage areas, if care is taken to guard against freezing. Light should be excluded from storage areas, for best results.

IV Harvesting and Handling Produce for Storage

How successfully your produce keeps depends on the following conditions:

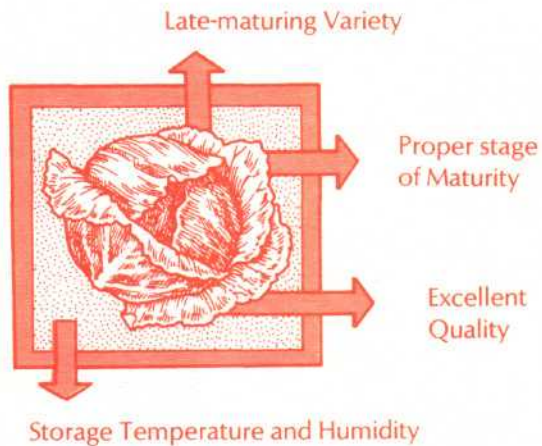

Crops held in storage are still living plants that are made nearly dormant by their environment. The stored produce is subject to respiration, breakdown, and decay, the same as before storage.

Crops should be as free as possible from skin breaks, bruises, or decay. Bruises and skin breaks are the principle means of entry for decay organisms and they also greatly increase moisture loss. The inclusion of one diseased or damaged

Leave approximately 1" of stem on most vegetables

Curing helps to heal slight skin injuries

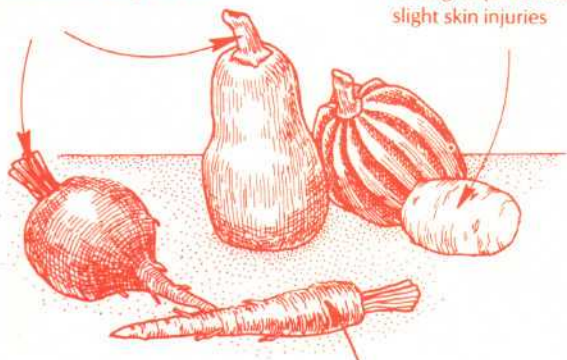

Stored produce must be free of bruises, skin breaks, or decay

specimen can start decay that will rapidly destroy other stored food or taint flavors with mustiness. Store only products of excellent quality; this will minimize the necessity of excessive handling to cull and remove that "one rotten apple in the barrel".

Late-maturing varieties of fruits and vegetables are the type suitable for storage. In general, you want to delay the harvest as long as possible, as you are dependent on the cold weather to keep the produce dormant. If you are growing your own produce, you can provide enough vegetables for in-season eating and winter storage; this requires forethought to control the time of maturity. If you are buying produce wholesale or from farmer's markets be sure to buy late-maturing varieties suitable for storage.

Refer to Section V for specific information on the proper stage of maturity for fruits and vegetables you wish to store. This will vary from product to product.

Produce should have as little field heat as possible when put into storage. Harvesting should therefore be done very early in the morning, or the crops should be cooled outdoors overnight. Try to harvest during dry weather, not too soon after a rain, and allow the surface of the produce to dry, as wet produce is more susceptible to disease. It is better not to wash root crops before they are stored; in fact, a thin crust of dry soil helps to prevent shriveling. Handle carefully when harvesting and preparing for storage to keep bruising to a minimum.

Figure 17. Place produce in storage as soon as possible after harvest, once the field heat has been removed.

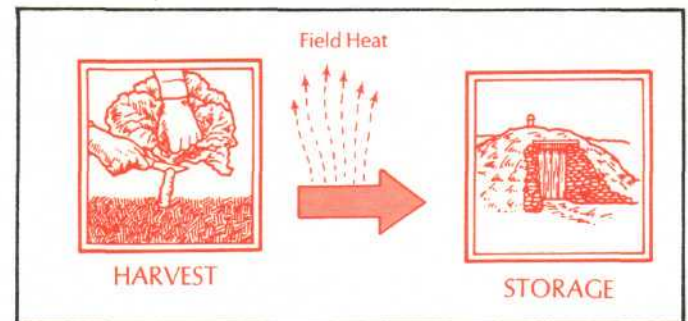

An inch or more of stem should be left on most vegetables to reduce water loss and help prevent infection. Vegetables requiring very moist conditions should be kept *in* something, rather than exposed to air.

Packing Materials

Packing materials used in storage perform several functions—insulation against fluctuating temperatures and freezing, moisture retention and reduction of disease transmission.

In outdoor storages, materials such as clean straw, dry leaves, corn stalks, hay, or sawdust are commonly used for insulation. These materials may be readily available or can be obtained relatively cheaply from local farms, or farm supply outlets. Always be certain that these materials are not contaminated with pesticides. Containers stored in unheated areas can be insulated with the above materials, or with sphagnum or peat moss, or with recycled foamed polystyrene materials. These materials should be used for one storage season only, as they may become contaminated with bacteria or spores. With the exception of polystyrene materials, they can be recycled as mulch in the garden.

Packing Materials

Clean Straw
Sawdust
Sphagnum Moss
Peat Moss
Dry Leaves
Sand

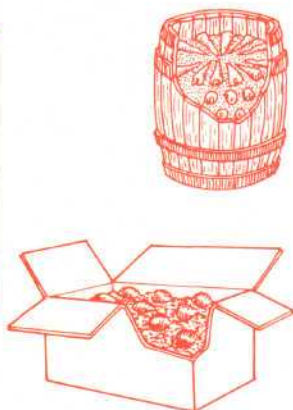

Moisture retention of produce stored in cellars is usually achieved with moistened sand, sawdust, sphagnum or peat moss. Plastic bags or linings for boxes, crocks, metal cans with cardboard liners, or plastic garbage cans are all ways to keep moisture in. Plastic bags or liners should always be perforated at regular intervals to permit air circulation and prevent condensation.

Transmission of disease is reduced by alternating layers of produce with packing materials. Individual wrapping of produce with newspaper or tissue paper aids moisture retention, and reduces the possibility of cross-transfer of odors and disease.

Timing of Storage

Placing fruits and vegetables in storages, either in pits or in basement rooms, *before* cold weather starts in the fall is a frequent cause of early spoilage. One of the most difficult steps in successful storage is to keep the produce in prime

Figure 18. Typical Moisture Retention Methods



condition from the time of optimum maturity until the night temperature is low enough to cool the storage place. The most complete retention of nutrients will be achieved if the produce can be stored under the proper conditions immediately at harvest.

Use of Stored Produce

After several months, the quality of stored produce may begin to deteriorate, particularly when not stored under ideal conditions. As long as they are firm, crisp, and have good flavor, their nutritive value is close to that of the fresh crop, but when they begin to shrivel their food value decreases.

Use fruits and vegetables quickly after taking them out of cold storage; they will not keep as long as will freshly harvested produce.

When spoilage begins in earnest, stored produce can be preserved by canning or freezing. Several months after harvest, processing for longer term preservation will be less hurried, and there will likely be empty canning jars, and room in the freezer.

Use produce quickly after removal from storage



V Specific Storage Conditions

Vegetables

Produce harvested at peak maturity from the garden has better flavor and higher nutritional value than produce available in the supermarket.

Table 4. Recommended Storage Conditions, Storage Duration, and Highest Freezing Point for Specific Vegetables

Commodity	Temperature, °F	Relative Humidity	Average Storage Life	Highest Freezing Point, °F
Beets	32	95%	1-3 months	30.3
Brussels sprouts	32	90-95%	3-5 weeks	30.5
Cabbage	32	90-95%	3-4 months	30.4
Carrots	32	90-95%	4-6 months	29.5
Cauliflower	32	90-95%	2-4 weeks	30.6
Celeriac	32	90-95%	3-4 months	30.3
Celery	32	90-95%	2-3 months	31.1
Chinese cabbage	32	90-95%	1-2 months	----
Dry Beans	32-50	65-70%	1 year	unaffected
Endive	32	90-95%	2-3 weeks	31.9
Garlic	32	65-70%	6-7 months	30.5
Horseradish	30-32	90-95%	10-12 months	28.7
Jerusalem Artichoke	31-32	90-95%	2-5 months	----
Kale	32	90-95%	10-14 days	31.1
Kohlrabi	32	90-95%	2-4 weeks	30.2
Leeks	32	90-95%	1-3 months	30.7
Onions	32	65-70%	5-8 months	30.6
Parsnips	32	90-95%	2-6 months	30.4
Peppers, Dry	32-50	60-70%	6 months	----
Peppers, sweet	45-50	90-95%	8-10 days	30.7
Potatoes	58-40	90%	5-8 months	30.9
Pumpkins	50-55	70-75%	2-3 months	30.5
Rutabaga	32	90-95%	2-4 months	30.1
Salsify	32	90-95%	2-4 months	30.0
Sweet Potato	55-60	85-90%	4-6 months	29.7
Tomatoes, mature green	55-60	85-90%	2-6 weeks	31.0
Turnips	32	90-95%	4-5 months	30.1
Winter Radishes	32	90-95%	2-4 months	30.7
Winter Squash	50-55	70-75	3-6 months	30.5

Beets

32°F, Very Moist



Beets can be stored in the garden where they grew if mulched under 1 1/2 - 2' of insulating material. For root cellar storage, harvest before fully mature in the late fall when the night temperatures drop to around 30°F, and when the soil is dry. Dig or pull the beets, retaining the roots with surrounding soil. Allow to dry in the sun so that the surface dirt falls free. Leave at least 1" of stem to retain nutrients and prevent bleeding. Do not wash before storing. Store at the bottom of the cellar, or where humidity is highest, packed in bins or crates between layers of moist sand, sawdust, sphagnum or peat moss. Containers could also be lined with a perforated plastic sheet.

Brussels Sprouts

32°F, Very Moist



Brussels sprouts can withstand some light freezing, and can be stored in the garden for several months. Or, store on the stem in the root cellar, or in small containers with ventilation. Storage in the freezer is a good alternative to fresh storage.

Cabbage

32-35°F, Very Moist



Late fall or winter cabbage can be stored effectively several ways. After the cabbage is fully mature, and the weather is cool, or after the first night of frost, pull up with root attached,

discarding the loose outer leaves and checking for insect infestation. Cabbage has a strong odor which can permeate other produce or spread through the house. In cellars, they can be hung up by their root, or wrapped in several sheets of newspaper tied with a string, and placed in a crate or box. Outdoor pits, trenches, and buried containers are all effective storage places.

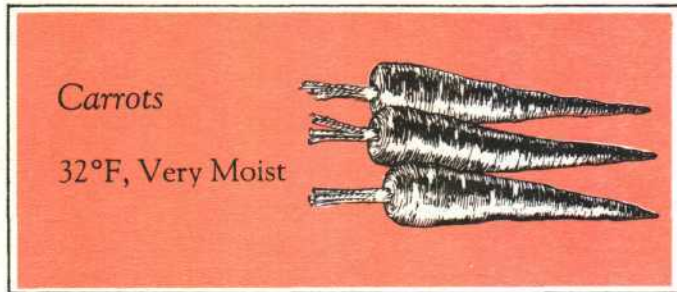

Plant late in the season, allowing time to mature before frost. If winters are severe, 1' of insulating material will protect them in the ground throughout the winter, and they can be dug as needed. If they are to be stored outside the garden, dig before the ground freezes. Dry and remove excess dirt, cut the stem close to the carrot and pack in fresh sawdust or other packing material. Store like beets in a cool, moist place. They will be sweet and delicious, if not overly mature.

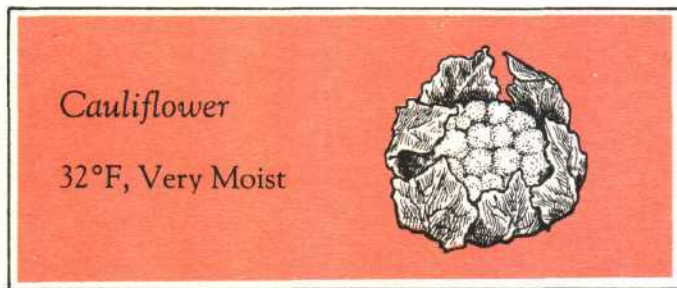

Cauliflower can withstand early frosts. For short term storage, cut off the root and leave the outer protective leaves. Store in containers with loose moist sand around and covering heads.

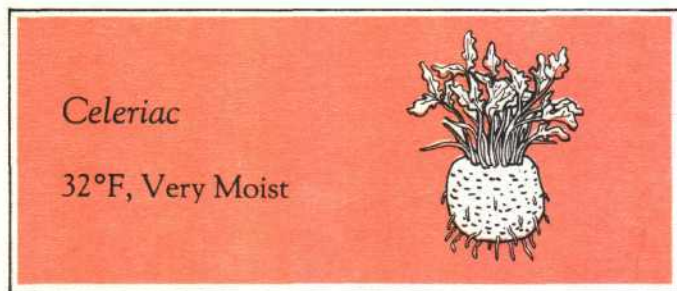

This unfamiliar vegetable has a delicate, nutlike flavor similar to celery, and the large thick root is eaten raw or boiled in stews. Celeriac can be stored in a cellar like beets, or heavily mulched in the garden.

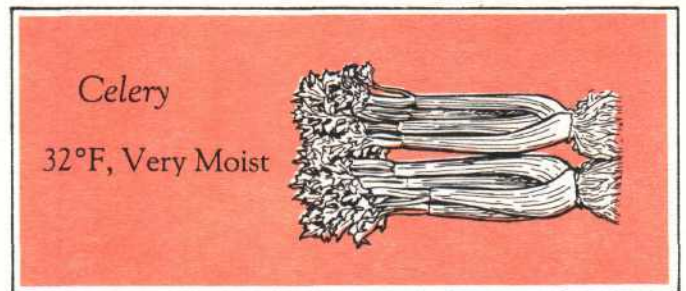

Late-maturing varieties can be harvested from the garden until a hard frost, if heavily mulched. For longer storage in a cellar or trench, pull up the plant with the root ball and the tops. They should be stored upright in close-together bunches. The roots should be in moist sand or soil, but take care not to store with water on the leaves. Do not store near turnips or cabbage as celery will absorb odors.

Remove field heat from produce before placing in storage.

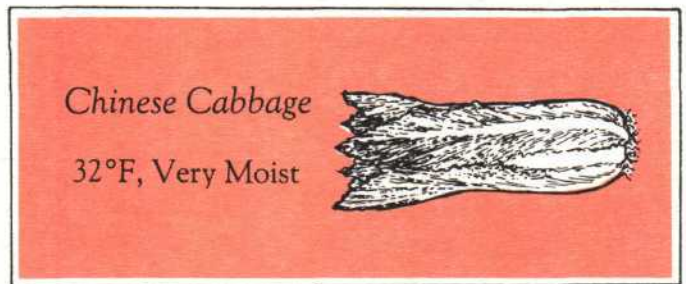

Chinese cabbage can be stored 1 to 2 months at 32°F; storage life is shorter at higher temperatures. Remove outer diseased or injured leaves before heads are stored. Storing like celery with roots in moist sand can help keep necessary high moisture levels.

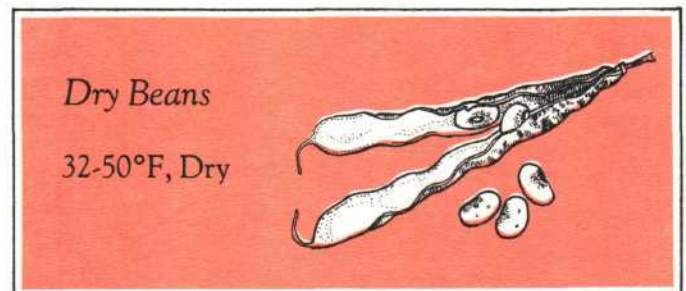

Dry Beans, such as kidney, navy, black turtles, white marrows, and pinto beans will be mostly dry on the vine by mid-fall, if planted early in the season. Harvest by pulling the entire vine, and spread them out or hang to dry for several weeks. The beans can be removed from the pods by banging the plant from side to side in a barrel or can, so the beans will fall to the bottom. When the beans are totally dry, store in clean containers, with tight lids, in a cool, dry place. Dry beans will not be harmed by freezing. Put in containers on a dry day and check periodically for moisture. If moisture reappears, re-dry and repack in clean dry containers.

Endive (Escarole)

32°F, Very Moist



Endive is a salad green with slightly pungent outer leaves and milder inner leaves. It can be moved after frost to a cellar with the outer leaves tied around the heads to blanch the centers. Like celery, store upright close together with moist sand or soil around the roots.

Garlic

32°F, Dry



Garlic requires a long growing season. It is harvested before the ground freezes, or when the tops have dried completely. Like onions, they must be air-dried (out of direct sun) for 2-3 weeks, or until the roots are completely dry. Cut off the roots with scissors to 1" from the bulb. Store in mesh bags, or with tops braided they can be suspended in a cool, dark, airy place.

Horseradish

30-32°F, Very Moist



Horseradish can be dug from the garden, as needed, throughout the winter and spring, or they can be stored like other root crops. Alternate thawing and freezing in the garden is undesirable, so mulch after thorough freezing.

Jerusalem Artichoke

31-32°F, Very Moist



These crisp tubers are low in calories and are eaten raw in salads, or are similar to potatoes when cooked. In the late fall, dig the tubers and store like roots crops in the cellar, or they can be stored in the garden where they grew.

While there are optimum temperature and moisture conditions for storage of fruits and vegetables, some variation of conditions can be tolerated.

Kale

32°F, Very Moist



Kale is rich in vitamins A and C and can be eaten raw in salads, or cooked, as greens. It can be sown any time, and is hardy enough to last several winters. A light frost improves the flavor, but it should be protected with insulating material before snow falls. It can be harvested in late winter and early spring when the root crops are beginning to lose large amounts of vitamin C. Handle like celery if storing in a cellar or trench.

Kohlrabi

32°F, Very Moist



The edible portion of this vegetable is a large bulb produced on the stem above the ground. It is best eaten raw, but it can also be cooked in stews and soups. Harvest when the bulbs are the size of large eggs; the larger ones may be woody. Store for a short period of time in the cellar, like beets.

Leeks

32°F, Very Moist



Leeks have a mild flavor and are richer in nutrients than other members of the onion family. Sow early in the spring, and once well established blanch the long necks for better flavor by drawing earth up around the base. Store under insulating material in the garden, or handle like celery.

Onions

32°F, Dry



The best varieties for storage are grown from seeds rather than sets. Harvest when the tops have turned brown and died, or in the late fall before the ground has frozen, even if the tops have not died. Remove any bruised onions or onions with thick necks and use promptly. Before storage onions must be cured or allowed to dry for several weeks until the skins are papery and the roots are completely shrivelled and dry. They can be spread on newspapers out of direct sunlight in a well ventilated area, or dried on an open screen off the ground. If they are taken indoors at night the drying process will be faster, as the drop in night temperatures increases the moisture levels. When cured, the tops can be braided, using string for reinforcing, or put into mesh bags or open crates and stored in a well-ventilated, dry, dark, cool place. Onions subject to light freezing may recover with little damage if they are allowed to thaw slowly without being handled.

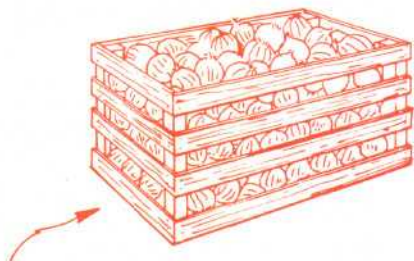

Onions can be stored in crates, mesh bags or braided using reinforcing string, providing they are placed in a cool, dry place, slightly above freezing

Parsnips

32°F, Very Moist



Parsnips are tender and delicious when small to medium size, especially after light frost, which adds sweetness to their flavor. If stored in the garden, insulating material will facilitate digging in the winter. In the spring, they become pithy and not very edible after new growth begins. They can also be stored in cellars and pits like other root crops.

Peppers, Hot

32-50°F, Dry



After the fruit is mature, they can be threaded onto a string and hung to dry without touching in an airy location. Store in a cool dry location. They will keep indefinitely, but are best used within one year before they lose some of their pungent flavor.

Peppers, Sweet

45-50°F, Very Moist



Firm, dark, green fruits can be stored for a short period of time in perforated bags in a cool location. Freezer storage is recommended when loss in quality begins.

Potatoes

38-40°F, Moist



Both early and late varieties of potatoes can be stored, but the late varieties can be held much longer. Harvest after the vines have died down completely and when the ground is dry. Dig carefully to avoid bruising and allow the surface to dry. For 10 to 14 days after harvest they should be cured at 45-60°F in darkness. After this period, the optimum storage temperature is 40°F; lower temperatures tend to turn the starch to sugar and sprouting will occur.

As the optimum temperature is higher than for most root crops, keep potatoes high up in the cellar, if possible. In cellars they can be stored in crates, or bins. Culling will be easier if they are not piled deeper than 12-18".

Potato sprouts should be removed when they appear, usually toward the end of winter. Early sprouting indicates too high storage temperatures, but may also be caused by gas given off by apples. Avoid storing apples and potatoes together as potatoes can also make apples musty. Potatoes turn green and become bitter if exposed to light. Cut off the green parts and discard.

Rutabaga

32°F, Very Moist

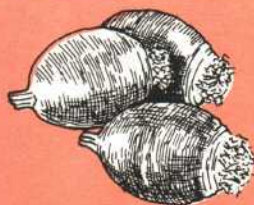

Harvest in the late fall, just before the ground freezes. Leave 1" of stem and the root intact. Store outdoors in pits, or in cellars in boxes, layered with sawdust or sphagnum or peat moss.

Any food storage area must be protected from mice and rats.

Salsify

32°F, Very Moist



Salsify or oyster plant is a tasty vegetable which is easy to grow, but requires a long growing season. It is hardy enough to leave in the ground over winter for early spring use. Where winter temperatures drop below 20°F, apply a layer of insulating material. For winter use, dig the roots in the fall, leaving 1" of stem. Store in moist sand in the cellar or in pits or buried containers in the garden.

Sweet Potatoes

55-60°F, Moist



Sweet potatoes are more difficult to store than regular potatoes. They must be handled with extreme care as they bruise easily. After the first frost, dig the roots carefully and cure to heal injuries for about one week in a warm (80-90°F) airy place, possible near a furnace duct or radiator. If the temperature is below 75°F, cure for 2-3 weeks. After curing they are stored like pumpkins and winter squash in a moderately warm and dry place. Avoid temperatures below 50°F.

Tomatoes

55-60°, Moist



Mature, green to slightly pink tomatoes can be stored for 1-2 months. Plant late or long growing varieties for storage. Sort according to ripeness and spread on rack covered with newspapers. Cover with paper to keep dark and retain moisture. Check every week to select ripe fruits and remove any spoiled fruit. They can also be brought indoors on the vine, and hung up in a cool place where they will gradually ripen. You can regulate the ripening process to some extent by means of temperature. At 65-70°F they ripen (out of direct sunlight) in about two weeks; at 55°F they ripen in 3-4 weeks. Do not store below 50°F or they will spoil.

Turnips

32°F, Very Moist



This crop is best grown in cool weather. Plant late in the summer for winter storage and harvest *before* fully mature, while they are still small and tender. Frost improves their flavor. Leave about one inch of stem on the turnip and store like beets. Turnips have a very strong odor so store away from other vegetables in the cellar.

Winter Squash and Pumpkins

50-55°F, Dry

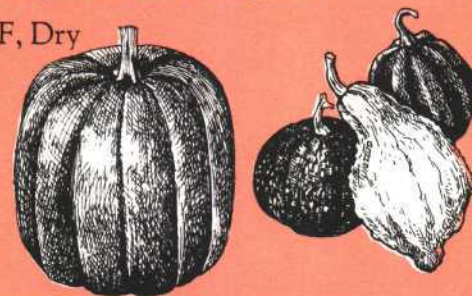

There are many flavorful varieties of winter squash which can be cooked or eaten raw. The squash with the deepest orange flesh have the largest amounts of vitamin A. They must remain on the plant until fully mature. Maturity can be roughly estimated by pressure from the thumbnail on the fruit skin; if the skin is hard and impervious to scratching, the fruit is mature.

Harvest squash and pumpkins before hard frost with a sharp knife, leaving at least 1" of stem attached. Fruit picked without the stem will soon decay around the stem scar. Handle carefully to avoid bruising the outer wall or stem. All winter squash and pumpkins should be cured in a warm, dry place for about 10 days at 75-85°F and then stored in a warm (50-55°F), dry area where the temperatures do not fluctuate too much. Examine every few weeks for mold; discard any contaminated produce and wipe the remaining squash carefully with a cloth made slightly oily with vegetable oil.



Winter radishes need cool weather at the end of their growing season. Sow seeds in mid-summer for winter storage. Store roots in moist sand in cellars, or in pits for use in early winter.

Fruits

Many fruits can be preserved only by freezing or canning. Of the fruits that do store well only those that mature in the late fall or that can be purchased in the winter can be considered for home storage. Apples and pears can be stored long-term, and grapes for a shorter time.

Table 5. Recommended Storage Conditions for Fruits

Produce	Recommended Temperature	Relative Humidity	Freezing Point, °F	Approximate Storage Life
Apples	30-40°F	90%	29.3	2-7 months*
Grapefruit, Fla. & Texas	50°F	85-90%	30.0	4-6 weeks
Cal. & Ariz.	58-60°F	85-90%	30.0	4-6 weeks
Grapes, Vinifera	30-31°F	90-95%	28.1	3-6 months
American	31-32°F	85%	29.7	2-8 weeks
Oranges, Fla. & Texas	32°F	85-90%	30.6	8-12 weeks
Cal. & Ariz.	38-48°F	85-90%	29.7	3-8 weeks
Pears	29-31°F	90-95%	29.2	2-7 months*

* Length of storage depends on variety

If you plan to store a large quantity of fruit each year, special facilities should be provided. Fruits generally prefer a cooler temperature than most vegetables and constant air circulation is necessary to remove gaseous substances, produced by the fruits which can speed up the ripening process if not removed.

For best results store fruits and vegetables separately.

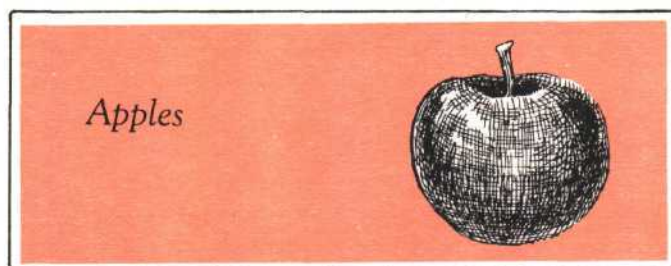
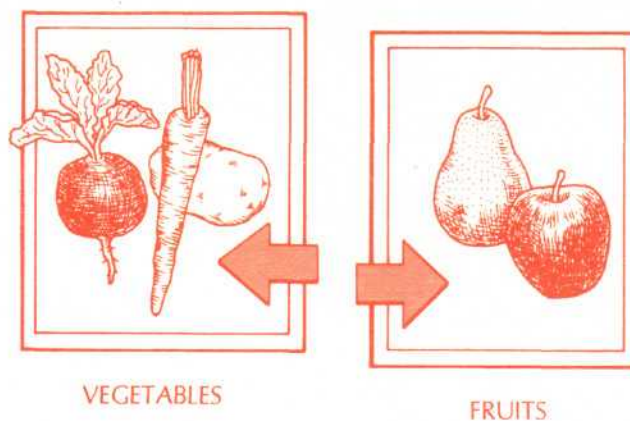

Late maturing varieties of apples will store for use throughout the winter if the fruit is hard, mature, and in perfect condition. Apples picked too green are subject to a number of storage disorders, such as scald and bitter pit; if picked beyond maturity, they quickly become overripe in storage.

Table 6. Storage Duration for Different Apple Varieties

Variety	Normal Storage Period ¹
Winesap	5-7 months
Yellow Newton	5-6 months ²
Rome Beauty	4-5 months
York Imperial	4-5 months
Northern Spy	4-5 months
Cortland	3-4 months
Delicious	3-4 months
Rhode Island Greening	3-4 months
McIntosh	2-4 months ²
Jonathan	2-3 months ²

¹If stored under ideal conditions

²Require higher storage temperatures (35-40°F), therefore controlled atmosphere (CA) storage is required for maximum storage duration.

Cool as quickly as possible after harvest for best results. For most varieties of apples, the optimum storage temperature is 30-32°F with a 90% relative humidity. Higher storage temperatures reduce the storage life considerably, as apples ripen twice as fast at 40°F as at 32°F.

Apples can be stored outdoors in insulated boxes or straw-lined pits or buried containers as long as the outside temperatures are above 10°F. They will last longer and retain more flavor if kept in a fruit cellar in plastic bags or in cardboard boxes lined with plastic sheets. The cardboard box and plastic bags or liners must be perforated to allow air circulation. If the fruits are individually wrapped in tissue paper or newspaper before being placed in boxes or baskets, you will achieve better results. Plastic liners help maintain high humidity and prevent the apples from being affected by the surrounding air. The balance of humidity is subtle; excess humidity will encourage decay, and insufficient humidity will encourage shrivelling.

Avoid storing apples too long and regularly check for signs of spoilage. Mustiness will spread to healthy specimens. When spoilage or withering becomes a problem, the apples can be preserved by canning techniques. The storage duration depends on the variety.

Spoilage and spore contamination will quickly spread to other produce.

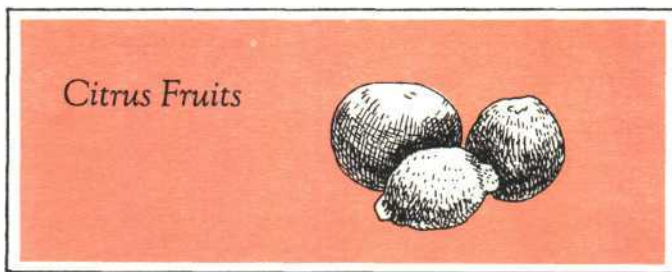

Grapefruits, oranges, and other citrus fruits can be held for 4-8 weeks or longer in a fruit cellar. They should be packed in open boxes and inspected often for spoilage. If mold appears, remove unsound fruit and wipe mold off sound fruits which may have been touched.

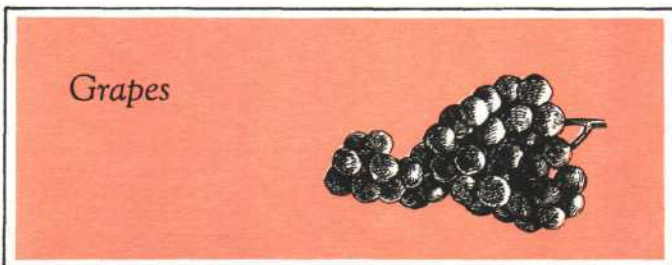

Grapes can be stored as whole fruit in a cellar for 4-6 weeks. Storage can be useful to hold the fruit until processing as juice or wine can be accomplished or to extend the time they can be eaten as table grapes. Grapes will readily absorb odors from other fruits; keep them away from other produce if possible. They can be stored in cardboard boxes, or crates

lined with a layer of clean, dry straw. Pack bunches no more than two or three layers deep and place straw or sawdust between each bunch. Check often for spoilage.

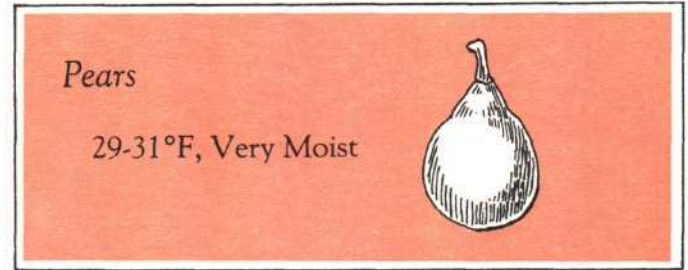

Several varieties of pears can be stored for fall and winter use in a basement fruit cellar. They should be picked at optimum maturity when they are hard and the color has changed from dark to pale green. Select only perfect specimens for storage.

Pears are very sensitive to temperature and should be stored at 29-31°F. The storage life of some pears can be one third longer at 30°F than at 32°F. Also, precise temperature control is required to prevent freezing.

Pears lose moisture rapidly. For storage, wrap individually in tissue or newspaper and store in cardboard boxes lined with perforated plastic.

Pears ordinarily do not ripen at storage temperatures as do apples. If pears are stored too long or at too high temperatures, or the temperature of ripening is too high (above 85°F for most varieties, but as low as 70-75°F for Keiffers) they will break down without ripening, often becoming rotten inside while the outside looks sound.

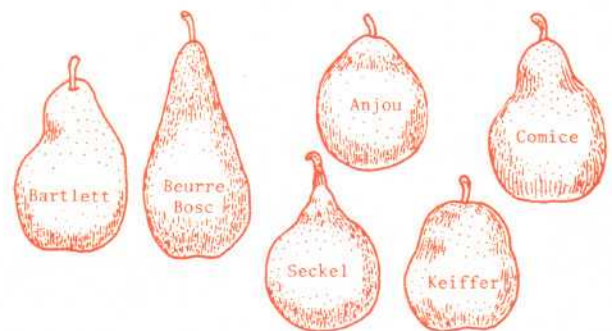

Table 7. Storage Duration for Different Pear Varieties

Variety	Normal Storage Period ¹
Winter Nelis	6-7 months
Anjou	4-6 months
Bosc	3- 3.5 months
Keiffer	2.5-3 months
Comice	2.5-3 months
Bartlett	2.5-3 months

¹Based on proper maturity and optimum storage conditions.

Other Stored Foods

Canned Goods



The storage temperature of canned goods affects the long-term retention of some nutrients. At temperatures below 65°F, very little loss occurs. Store in cool, dark, dry locations such as basements and pantries. Moist storage rooms are not suited to storage of canned goods as the can lids may rust and possibly result in a broken seal.

Cheese

Cool, Moist



Hard cheese will store better in a root cellar than in the refrigerator or freezer. Wrap the cheese in a clean, dampened cloth. An outer layer of perforated plastic will help retain this moisture and prevent the outer edges of the cheese from hardening. Strong smelling cheeses should be wrapped and kept in containers such as crocks or plastic tubs.

Nuts

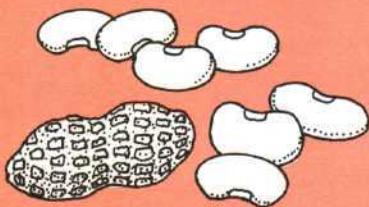

If you store nuts (especially peanuts), soybeans, other dry beans or peas, make every effort to prevent the growth of molds. A harmful toxin may be produced if mold growth is allowed to progress. Discard all produce that shows any sign of decay.

VI Plans

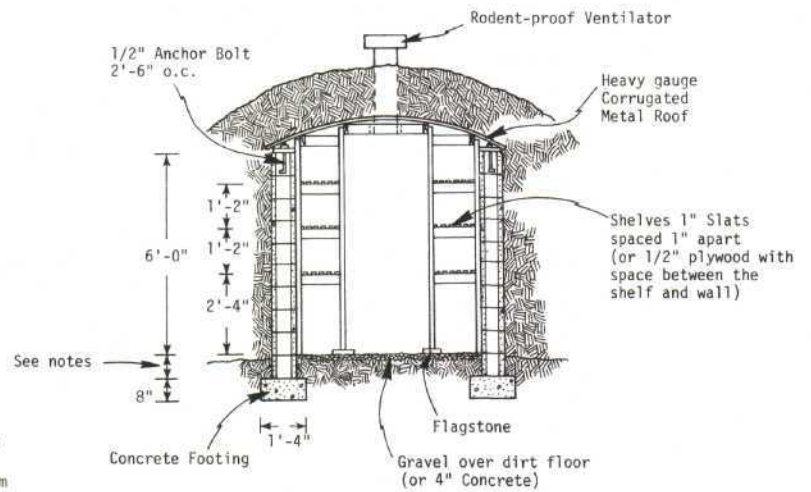
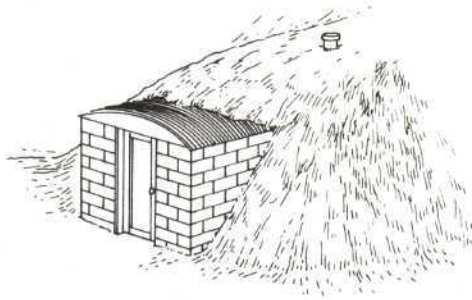

NOTES :

All interior framing is 2 x 4 lumber unless otherwise noted

Place storage room footing 6 to 8" below grade and work room footing below frost line

The storage room may be constructed in a hillside to eliminate the need for extra soil overfill

SECTION A - A

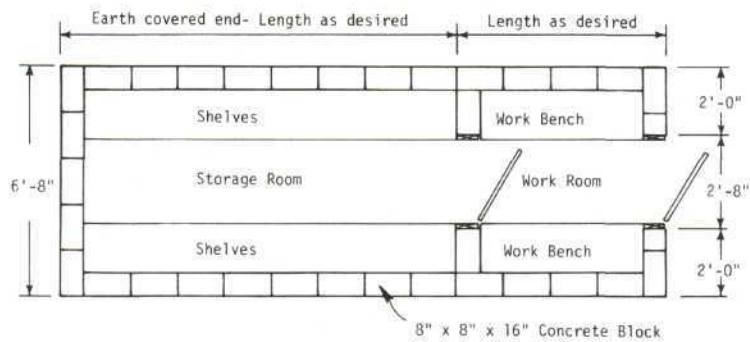

PLAN

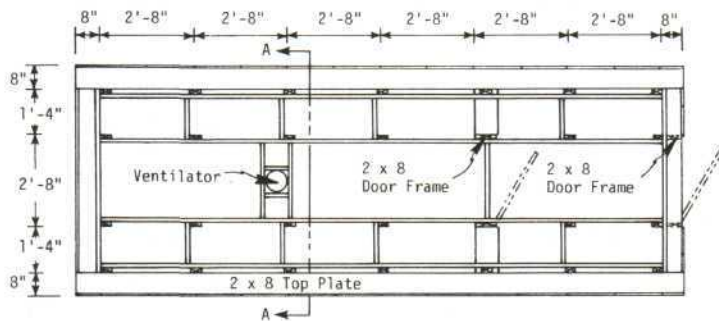

ROOF FRAMING PLAN

STORAGE CELLAR	
West Virginia '79	Sheet 1 of 1

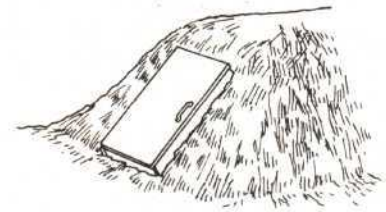
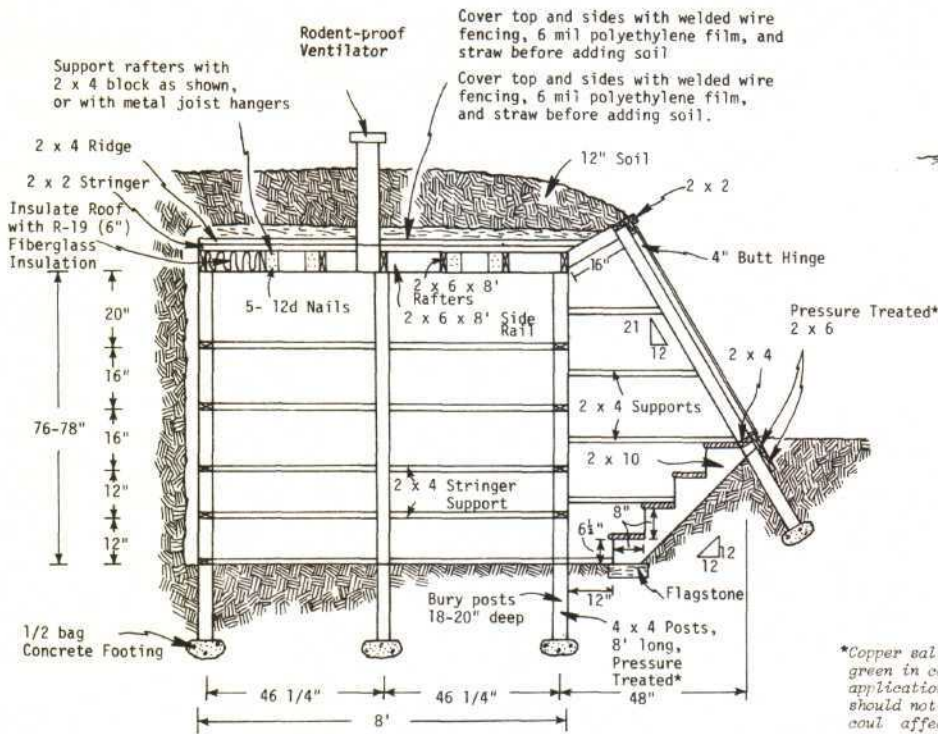

*Copper salt preservatives, typically green in color, are best for this application. Creosote and Penta should not be used because toxic fumes could affect the stored produce.

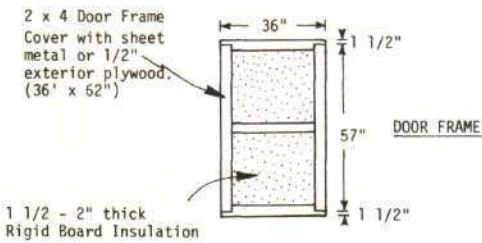

Optional Section. Room may be 4' x 5'.

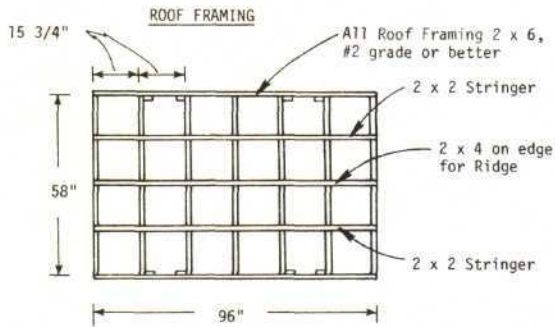
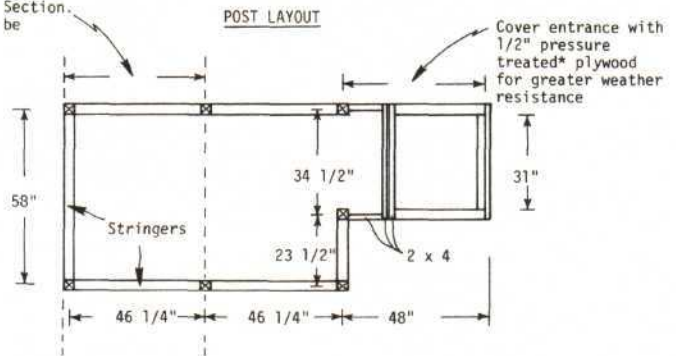

STORAGE CELLAR

NRAES '79

Sheet 1 of 1

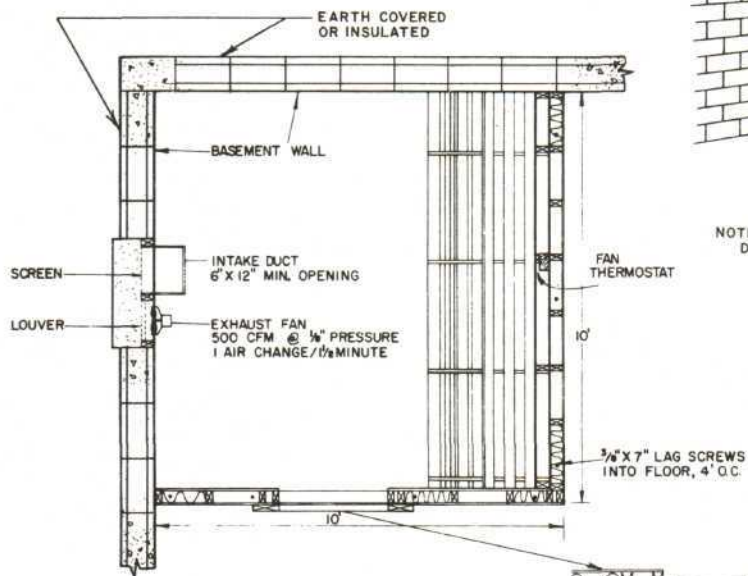

FLOOR PLAN
SCALE 1/4" = 1'

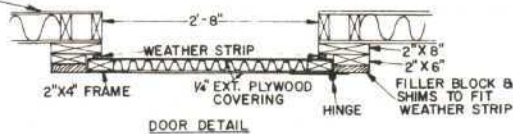

DOOR DETAIL

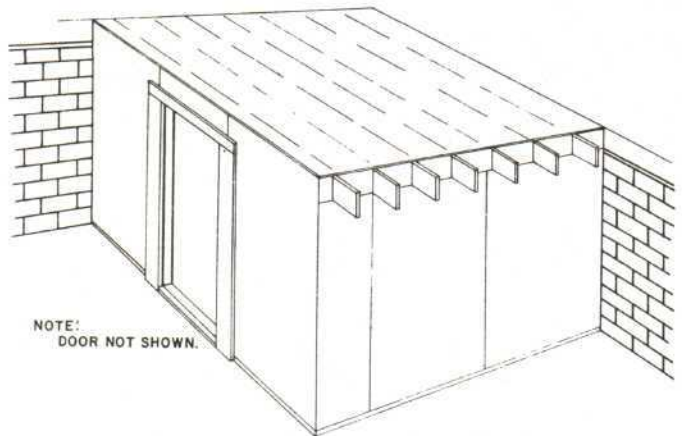

PERSPECTIVE
STORAGE ROOM IN CORNER OF BASEMENT

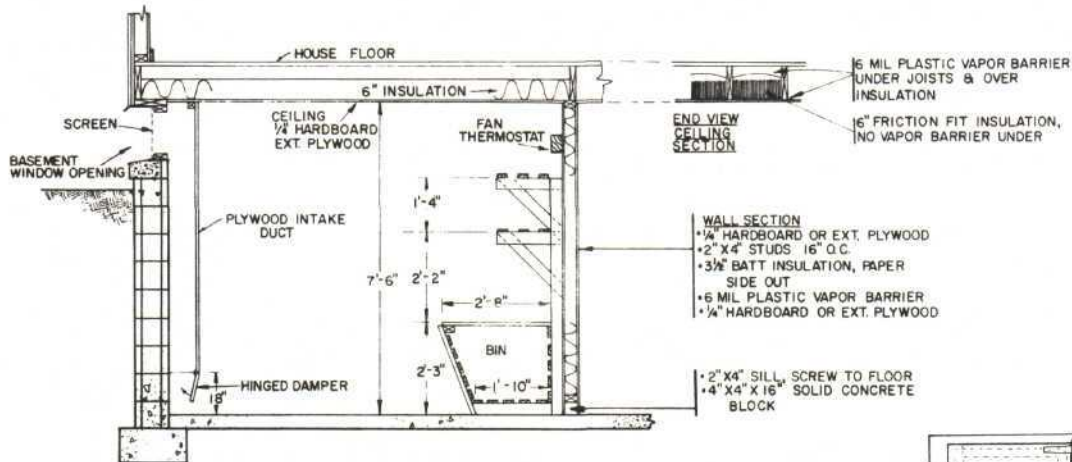

CROSS SECTION

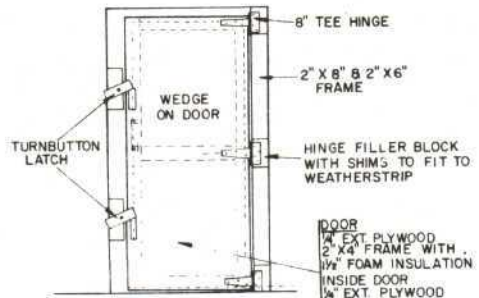

DOOR AND FRAME

- ALTERNATIVE TEMPERATURE CONTROLS**
- SINGLE THERMOSTAT - INSIDE CONTROL, OFF AT SET LEVEL TO PREVENT FREEZING, MANUAL OFF TO PREVENT WARMING.
 - DUAL THERMOSTATS - OUTSIDE CONTROL OFF AT SET LEVEL TO PREVENT WARMING, INSIDE SET TO PREVENT FREEZING.
 - DIFFERENTIAL THERMOSTAT, ON WHEN OUTSIDE COOLER THAN INSIDE, OFF AT SET LEVEL TO PREVENT FREEZING.

BASED ON: PENN STATE UNIV. PLAN NO. 734-418

FRUIT and VEGETABLE STORAGE ROOM

Pennsylvania '75 Plan #6226 Sheet 1 of 1

VII For Further Reading

Gardening for Food and Fun. The Yearbook of Agriculture-1977. U.S. Department of Agriculture. Available in libraries.

Home Drying of Foods. R. Klippstein and K. Humphrey. Information Bulletin 120, Research Park, Cornell University, Ithaca, NY 14853

Home Preserving Made Easy. V. Gewanter and D. Parker. Viking Press, NY 1975

Keeping Food Safe. H. Bradley and C. Sundberg. Doubleday and Co., NY 1975

Keeping the Harvest. N. Thurber and G. Mead. Garden Way Publishing, Charlotte, VT 05445. 1976

Managing Your Personal Food Supply. ed. R. Wolf, Rodale Press, Emmaus, PA 18049. 1977

Putting Foods By. R. Hertzberg, B. Vaughan, J. Greene. Bantam Books 1976

Self-Sufficiency: The Science and Art of Producing and Preserving Your Own Food. J. Seymour and S. Seymour. Faber and Faber, London 1973

Stocking Up. ed. C. Stoner, Rodale Press, Emmaus, PA 18049. 1975

Storing Vegetables and Fruits - in basements, cellars, outbuildings, and pits. U.S. Department of Agriculture Home and Garden Bulletin No. 119, 1977.

The Commerical Storage of Fruits and Vegetables, and Florist Nursery Stocks. J. Lutz and R. Hardenburg. U.S. Department of Agriculture Handbook 66. 1968. Out of print. May be available in university libraries.

The Home Pro Guide to Vegetable Gardening and Food Preserving, Minnesota Mining and Manufacturing Company, 1976.

The Green Thumb Preserving Guide, J. Anderson. William Morrow and Company, NY 1976

The Technology of Food Preservation. N. Desrosier, Avi Publishing, Westport, CT, 1970

The Northeast Regional Agricultural Engineering Service prepares publications under the direction of agricultural engineers and consulting specialists. It is an official activity of 12 Land-Grant Universities and the U. S. Department of Agriculture. The following are cooperating members.

University of Connecticut
Storrs, Connecticut 06268

University of Delaware
Newark, Delaware 19711

University of Maine
Orono, Maine 04473

University of Maryland
College Park, Maryland 20742

University of Massachusetts
Amherst, Massachusetts 01002

University of New Hampshire
Durham, New Hampshire 03824

Rutgers University
New Brunswick, New Jersey 08903

Cornell University
Ithaca, New York 14853

Pennsylvania State University
University Park, Pennsylvania 16802

University of Rhode Island
Kingston, Rhode Island 02881

University of Vermont
Burlington, Vermont 05401

West Virginia University
Morgantown, West Virginia 26506